

**PRESCRIBE Commands**  
**Technical Reference**

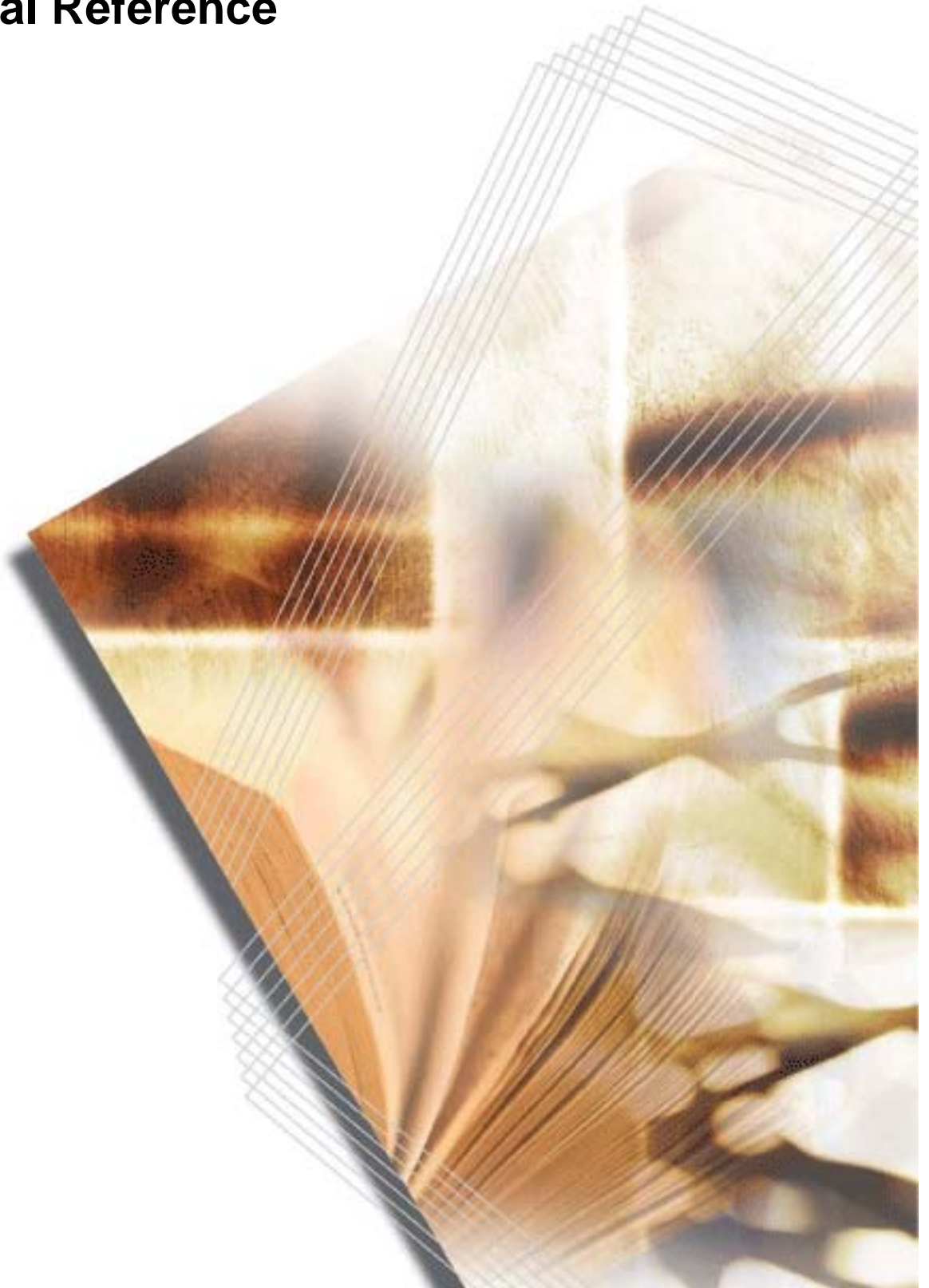



# General Information

## Notice

We shall have no liability or responsibility to customers or any other person or entity with respect to any liability, loss or damage caused or alleged to be caused directly or indirectly by equipment sold or furnished by us, including, but not limited to, any interruption of service, loss of business or anticipatory profits, or consequential damages resulting from the use or operation of the equipment or software.

NO LIABILITY WILL BE ASSUMED FOR ANY DAMAGE CAUSED BY IMPROPER INSTALLATION.

### Notice on Software

SOFTWARE USED WITH THIS PRINTING SYSTEM MUST SUPPORT ITS NATIVE MODE (PRESCRIBE) OR ONE OF ITS EMULATION MODES.

This manual, the computer programs in the printing system referred to in this manual, and any other copyrightable subject matter sold or provided with or in connection with the sale of the printing system, are protected by copyright. All rights are reserved. Copying or other reproduction of all or part of this manual, the computer programs, or any other copyrightable subject matter without the prior written consent of Kyocera Mita Corporation is prohibited. Any copies made of all or part of this manual, the computer programs, or any other copyrightable subject must contain the same copyright notice as the material from which the copying is done.

The information in this manual is subject to change without notification. Additional pages may be inserted in future editions. The user is asked to excuse any omissions or errors in the present edition.

No responsibility is assumed if accidents occur while the user is following the instructions in this manual. No responsibility is assumed for defects in the printing system's firmware.

## Regarding Tradenames

PRESCRIBE is a registered trademark of Kyocera Corporation. KPDL is a trademark of Kyocera Corporation.

Diablo 630 is a product of Xerox Corporation. IBM Proprinter X-24E is a product of International Business Machines Corporation. Epson LQ-850 is a product of Seiko Epson Corporation. HP LaserJet, Hewlett-Packard, PCL, and HP-GL/2 are registered trademarks of Hewlett-Packard Company. Other product names and company names that appear in this manual are trademarks or registered trademarks of their respective owners.

The Kyocera printing systems use PeerlessPrint5 to provide the HP LaserJet compatible PCL5 language emulation. PeerlessPrint5 is a trademark of The Peerless Group, Redondo Beach, CA 90278, U.S.A.

© Copyright 2005 - 2008 KYOCERA MITA Corporation  
All rights reserved  
Revision 4.51 2008.6

### Typeface Trademark Acknowledgement

All resident fonts in the printing system are licensed from Bitstream Inc. and Agfa corporation. For font license information for each model, refer to the User's Manual.

Helvetica, Palatino and Times are registered trademarks of Linotype-Hell AG. Century Schoolbook, Szymie, and Cooper-Black are trademarks of Kingsley-ATF Type Corporation. ITC Avant Garde Gothic, ITC ZapfChancery, ITC ZapfDingbats, ITC Souvenir, ITC Benguiat, and ITC Bookman are registered trademarks of International Typeface Corporation. Revue is a trademark of Esselte Pendaflax Corporation in the U.S., Letraset Canada Ltd. in Canada, and Esselte Letraset Ltd. elsewhere.

### Agfa Japan License Agreement Guidelines for the Resident Fonts

1. *Software* shall mean the digitally encoded, machine readable, scalable outline data as encoded in a special format as well as the UFST Software.
2. You agree to accept a non-exclusive license to use the Software to reproduce and display weights, styles and versions of letters, numerals, characters and symbols ("Typefaces") solely for your own customary business or personal purposes at the address stated on the registration card you return to Agfa Japan. Under the terms of this License Agreement, you have the right to use the Fonts on up to three printing systems. If you need to have access to the fonts on

more than three printing systems, you need to acquire a multi-user license agreement which can be obtained from Agfa Japan. Agfa Japan retains all rights, title and interest to the Software and Typefaces and no rights are granted to you other than a License to use the Software on the terms expressly set forth in this Agreement.

3. To protect proprietary rights of Agfa Japan, you agree to maintain the Software and other proprietary information concerning the Typefaces in strict confidence and to establish reasonable procedures regulating access to and use of the Software and Typefaces.
4. You agree not to duplicate or copy the Software or Typefaces, except that you may make one backup copy. You agree that any such copy shall contain the same proprietary notices as those appearing on the original.
5. This License shall continue until the last use of the Software and Typefaces, unless sooner terminated. This License may be terminated by Agfa Japan if you fail to comply with the terms of this License and such failure is not remedied within thirty (30) days after notice from Agfa Japan. When this License expires or is terminated, you shall either return to Agfa Japan or destroy all copies of the Software and Typefaces and documentation as requested.
6. You agree that you will not modify, alter, disassemble, decrypt, reverse engineer or decompile the Software.
7. Agfa Japan warrants that for ninety (90) days after delivery, the Software will perform in accordance with Agfa Japan-published specifications, and the diskette will be free from defects in material and workmanship. Agfa Japan does not warrant that the Software is free from all bugs, errors and omissions.

THE PARTIES AGREE THAT ALL OTHER WARRANTIES, EXPRESSED OR IMPLIED, INCLUDING WARRANTIES OF FITNESS FOR A PARTICULAR PURPOSE AND MERCHANTABILITY, ARE EXCLUDED.

8. Your exclusive remedy and the sole liability of Agfa Japan in connection with the Software and Typefaces is repair or replacement of defective parts, upon their return to Agfa Japan.  
IN NO EVENT WILL AGFA JAPAN BE LIABLE FOR LOST PROFITS, LOST DATA, OR ANY OTHER INCIDENTAL OR CONSEQUENTIAL DAMAGES, OR ANY DAMAGES CAUSED BY ABUSE OR MISAPPLICATION OF THE SOFTWARE AND TYPEFACES.
9. New York, U.S.A. law governs this Agreement.
10. You shall not sublicense, sell, lease, or otherwise transfer the Software and/or Typefaces without the prior written consent of Agfa Japan.
11. Use, duplication or disclosure by the Government is subject to restrictions as set forth in the Rights in Technical Data and Computer Software clause at FAR 252-227-7013, subdivision (b)(3)(ii) or subparagraph (c)(1)(ii), as appropriate. Further use, duplication or disclosure is subject to restrictions applicable to restricted rights software as set forth in FAR 52.227-19 (c)(2).
12. YOU ACKNOWLEDGE THAT YOU HAVE READ THIS AGREEMENT, UNDERSTAND IT, AND AGREE TO BE BOUND BY ITS TERMS AND CONDITIONS. NEITHER PARTY SHALL BE BOUND BY ANY STATEMENT OR REPRESENTATION NOT CONTAINED IN THIS AGREEMENT. NO CHANGE IN THIS AGREEMENT IS EFFECTIVE UNLESS WRITTEN AND SIGNED BY PROPERLY AUTHORIZED REPRESENTATIVES OF EACH PARTY. BY OPENING THIS DISKETTE PACKAGE, YOU AGREE TO ACCEPT THE TERMS AND CONDITIONS OF THIS AGREEMENT.

# Introduction

This manual contains information needed to use the firmware features provided by the Kyocera printing system. Among these features is PRESCRIBE, a highly accessible, human-readable command language that makes it easy for programmers to take full advantage of the printing system's capability.

The PRESCRIBE command language allows to:

- extensive manipulation of fonts and character code tables
- use the ability to draw objects by constructing and manipulating paths including ellipses and round boxes, etc.
- execute macros including carbon-copy macro
- control external optional units (feeders, etc.)

You can access the features of PRESCRIBE from any of the seven emulation modes. These modes include:

- Hewlett-Packard LaserJet emulation
- Hewlett-Packard HP 7550A (plotter) emulation
- IBM Proprinter X24E (24-pin dot matrix printer) emulation
- Epson LQ-850 (24-pin dot matrix printer) emulation
- Diablo 630 emulation
- generic line printer emulation
- KPDL (Apple LaserWriter II NTX (NT) emulation) [an option on some models]

## About the Technical Reference manual

The Technical Reference manual is organized into eight chapters. The first four chapters of this manual constitute a tutorial introduction to PRESCRIBE. The rest mainly concern advanced utilities and setups:

*Chapter 1 Introduction to PRESCRIBE* introduces some basic concepts of PRESCRIBE.

*Chapter 2 Graphics Tutorial* outlines the graphic handling features of PRESCRIBE.

*Chapter 3 Macros* introduces program macros, a concept that makes it easy to define sequences of PRESCRIBE commands, then call them repeatedly whenever they are needed.

*Chapter 4 Fonts* provides how to manage font selection and font samples.

Later, *Chapter 5 Barcodes* explains the barcode printing capabilities of the command language.

*Chapter 6 Permanent Parameters* explains how to reprogram the printing system's firmware for customization.

*Chapter 7 Emulation* gives notes on the printing system's various emulation modes.

An Index is also provided at the end of this manual.

### *Notice*

Most PRESCRIBE commands operate in the same way on all of these models. However, on particular models, some commands are irrelevant. Model-dependent differences are noted at the pertinent locations in this manual.

### *Conventions*

- *italic* is used for emphasis and also refers to a related chapter or section in this manual or another related document.
- `fixed-pitch` means text or commands that you must type exactly as it appears.

# Table of Contents

General Information .....	i
Introduction.....	iii

## Introduction to PRESCRIBE

Format of PRESCRIBE Commands .....	1-4
Basic Concepts.....	1-4
Edge Limits .....	1-4
Margins .....	1-4
Page Orientation and Direction .....	1-5
Coordinate Systems .....	1-7
Text Positioning .....	1-7
Character Spacing .....	1-8
Paths .....	1-9
Logical Page and Physical Page .....	1-9
Command Parameters.....	1-10
Numeric Parameters .....	1-10
Character Strings .....	1-11
Upper and Lowercase Letters .....	1-12
Special Parameters .....	1-13

## Graphics Tutorial

Drawing Lines .....	2-2
Drawing Boxes and Circles .....	2-6
Drawing Filled Shapes.....	2-9
Path Mode Graphics.....	2-16
Path .....	2-16
Drawing Lines.....	2-18
Miter Limit .....	2-21
Drawing Arcs and Curves .....	2-24
Drawing Complex Curves .....	2-26
Closed Paths .....	2-29
Filled Areas .....	2-30
Clipping Rectangle .....	2-32
Printing with Character Paths .....	2-33
Raster Graphics .....	2-34
Raster Data Compression Formats .....	2-34
Commands for Printing Raster Data .....	2-35
Printing Raster Data.....	2-37
Changing the Printing System's Imaging Model .....	2-37
Saving and Restoring the Graphics State .....	2-39

## Macros

Examples of Macros .....	3-3
--------------------------	-----

## Fonts

List of Fonts .....	4-2
KPD L Fonts .....	4-4
Substituting a Bitmap Font .....	4-6

Font Selection .....	4-7
Font Selection by PRESCRIBE Commands .....	4-7
Placement of Font Commands .....	4-11
Creation of New Symbols and Characters .....	4-12
Symbol Set.....	4-13
International Characters.....	4-14
Selecting HP Symbol Sets .....	4-14

## Barcodes

PDF417 Symbol Description.....	5-10
Printing a Two-dimensional Barcode .....	5-12
Limitations of Two-dimensional Barcode .....	5-13
Macro PDF417 .....	5-14
Creating a Macro PDF 417 Representation .....	5-14

## Permanent Parameters

Interface-dependent Parameters .....	6-2
Interface-independent Parameters .....	6-5

## Emulation

Automatic emulation sensing .....	7-3
General Information on Emulation .....	7-3
Line Printer Emulation (Mode 0) .....	7-3
IBM Proprinter X24E Emulation (Mode 1) .....	7-4
IBM Proprinter X24E Control Codes.....	7-6
Diablo 630 Emulation (Mode 2) .....	7-12
Diablo 630 Control Codes .....	7-14
Epson LQ-850 Emulation (Mode 5) .....	7-21
HP LaserJet Emulation (Mode 6) .....	7-33
LaserJet Fonts .....	7-35
LaserJet Symbol Sets.....	7-37
Resource Protection.....	7-40
Switching the Print Resolution .....	7-42
HP LaserJet Reset State.....	7-43
LaserJet PJI.....	7-43
PJI Syntax Comparison .....	7-66
HP 7550A Emulation [KC-GL] (Mode 8) .....	7-96
Basic .....	7-96
KC-GL Environment Options .....	7-97
Plotter Status Information .....	7-102
Device-Control Instructions .....	7-106
Fonts and Symbol Sets in KC-GL .....	7-107
Summary of KC-GL Instructions .....	7-111
KPDL Operators.....	7-115
Communication with the Printing System.....	7-115
KPDL Summary .....	7-116
KPDL Error Messages.....	7-139
KPDL Printable Area.....	7-140

## Index



## Introduction to PRESCRIBE

PRESCRIBE is the native language of the Kyocera printing systems including copiers (collectively referred to as *printing systems* hereafter). Consisting of easily remembered commands, such as 'SLM' for Set Left Margin, and 'BOX' to draw a box, it gives you the capability to control line and character spacing, adjust margins, change fonts, position text, draw graphics, and print multiple copies of each page. PRESCRIBE also gives freedom to control device settings including selection of paper source, output stack, and finishing operations such as sorting, stapling, etc.

Most application software controls printing systems by means of codes and escape sequences that are built into the program and are not directly visible to the user. In contrast, PRESCRIBE commands are made of ordinary characters that you can type in yourself and see on the computer screen. This makes it easy for you to customize printing and add features that may not be supported by your application.

This chapter presents an introduction to PRESCRIBE starting with an explanation of the commands by which you start and exit PRESCRIBE. It is followed by an introduction to some basic concepts of PRESCRIBE, then a discussion of the command format and command parameters.

# Entry and Exit

The printing system can be thought of as having a multiple personality. When its power is switched on, it performs the normal printing system functions of printing out files and other data. Application software can control the printing system using one of the seven emulations. When the printing system uses an emulation, it is said to be printing in emulation mode.

PRESCRIBE is an additional mode of operation in which the printing system understands data it receives not as text to be printed, but as commands to be executed. The PRESCRIBE mode is available at any time during operation from any emulation mode. The initializing string that takes the printing system from the usual text-printing mode into the PRESCRIBE mode is **!R!**. The command that returns it from the PRESCRIBE mode to the emulation mode is **EXIT;**. These transitions are diagrammed in the figure below.

Figure 1.1. Mode Transitions

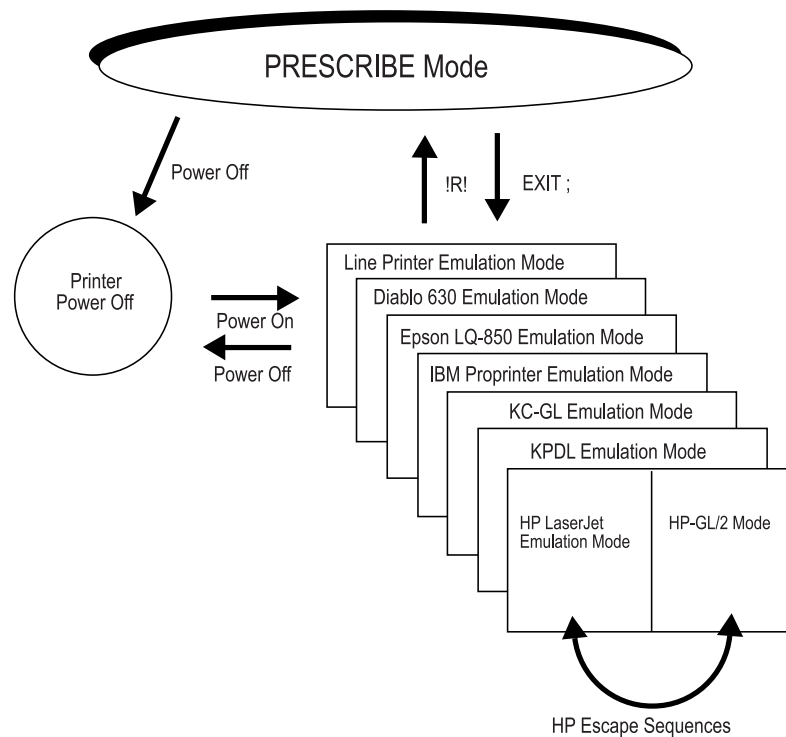

The printing system’s emulation mode can be permanently set by the FRPO (Firmware RePrOgram) P1 command. See *Chapter 7* for details. The printing system is factory-set to emulate the Hewlett-Packard LaserJet.

The example below shows how these transitions can be used in a file. The lines beginning with **!R!** are PRESCRIBE commands. Note how each block of commands begins with **!R!** and ends with **EXIT;**. These sections are not printed; instead, they set margins, select three different fonts, and draw a box around one line of text. The remainder of the file consists of ordinary text, and is printed out as shown in the figure on the next page.

Figure 1.2. Text Including PRESCRIBE Commands

```
!R! RES; SLM 1; STM 1; SPD 0.03; FTMD 13;  
      SFNT "Helvetica-Bd"; EXIT;  
WELCOME TO WINDFALL NATIONAL PARK  
!R! SFNT "Times-Rom"; EXIT;
```

The park entrance is located in the rolling hills of the Northern Woods, a forested area abundant in deer, elk, squirrel, rabbit, opossum, lynx, wolf, and other wildlife. It is the park's most popular area, featuring excellent trails and campsites for hiking and backpacking.

```
!R! BOX 3.4, 0.55; FSET 1s5B; EXIT;
```

Hikers should avoid this area during hunting season.

```
!R! SFNT "Times-Rom"; EXIT;
```

Hikers in search of high-altitude adventure will find Mt.Baker a rewarding...

Figure 1.3. PRESCRIBE Example

**WELCOME TO WINDFALL NATIONAL PARK**

The park entrance is located in the rolling hills of the Northern Woods, a forested area abundant in deer, elk, squirrel, rabbit, opossum, lynx, wolf, and other wildlife. It is the park's most popular area, featuring excellent trails and campsites for hiking and backpacking.

*Hikers should avoid this area during hunting season.*

Hikers in search of high-altitude adventure will find Mt.Baker a rewarding...

The previous example contains five sequences of PRESCRIBE commands. The basic configuration of a PRESCRIBE command sequence is:

```
!R! command; command; ...; command; EXIT;
```

There is a limit to the number of commands you can include between the initial !R! and the final EXIT;. The initial !R! must be followed by a space, and each command must end with a semicolon.



Note

The use of PRESCRIBE commands in document files is conditional on the behavior of your word processing software. Some word processing programs add control codes that interfere with PRESCRIBE. If you cannot control software in this way, try using a non-word processing mode (ASCII text function, for example) of the software.

## Format of PRESCRIBE Commands

The basic format of a PRESCRIBE command is:

••• or •••• (command name) parameter, ..., parameter;

The command names generally consist of three or four letters. In most commands, the parameters must be followed by commas. The last parameter is always followed by a semicolon. Some commands (RES, for example) have no parameters. In this case, the command should be followed immediately by a semicolon (RES ;).

The length of a single PRESCRIBE command is limited to 255 characters, from the first letter of the command name through the final semicolon. Commands longer than 255 characters are not executed.

Spaces, carriage return codes, and line feed codes are generally ignored in PRESCRIBE command sequences. These characters are not generally counted in the command length. (*Exception:* Spaces are not ignored in quoted character strings.) To improve readability, place at least one space before each command or place each command on a separate line.

## Basic Concepts

This section discusses a few basic concepts concerning how the printing system prints on the page. These concepts are:

- Edge limits
- Margins
- Coordinate systems
- Text positioning/Character spacing
- Paths
- Logical page and physical page
- Page orientation and direction

### Edge Limits

The printing system cannot place print on the outside edges of the paper. The edge limits to which printing is possible are located 5 mm inside the edges of the paper; or 6 mm (5mm in landscape orientation) from the left edge and 4 mm from the top of the paper in HP LaserJet emulation. Refer to the figure *Edge Limits and Margins* on page 5.

The edge limits adjust automatically to the size of the paper cassette (although not to the size of manually fed paper). The edge limits can also be set to various standard sizes by the SPSZ (set paper size) command, or by the equivalent HP LaserJet commands. In HP LaserJet emulation, the edge limits slightly vary according to the page orientation (as also shown in *Edge Limits and Margins* on page 5).

### Margins

The top and left margins are set in centimeters or inches in relation to the top and left edge limits of the page. The bottom and right margins can also be set as a distance from the top and left edge limits, or they can be set in terms of page width, page length, or lines per page.

Figure 1. 4. Edge Limits and Margins

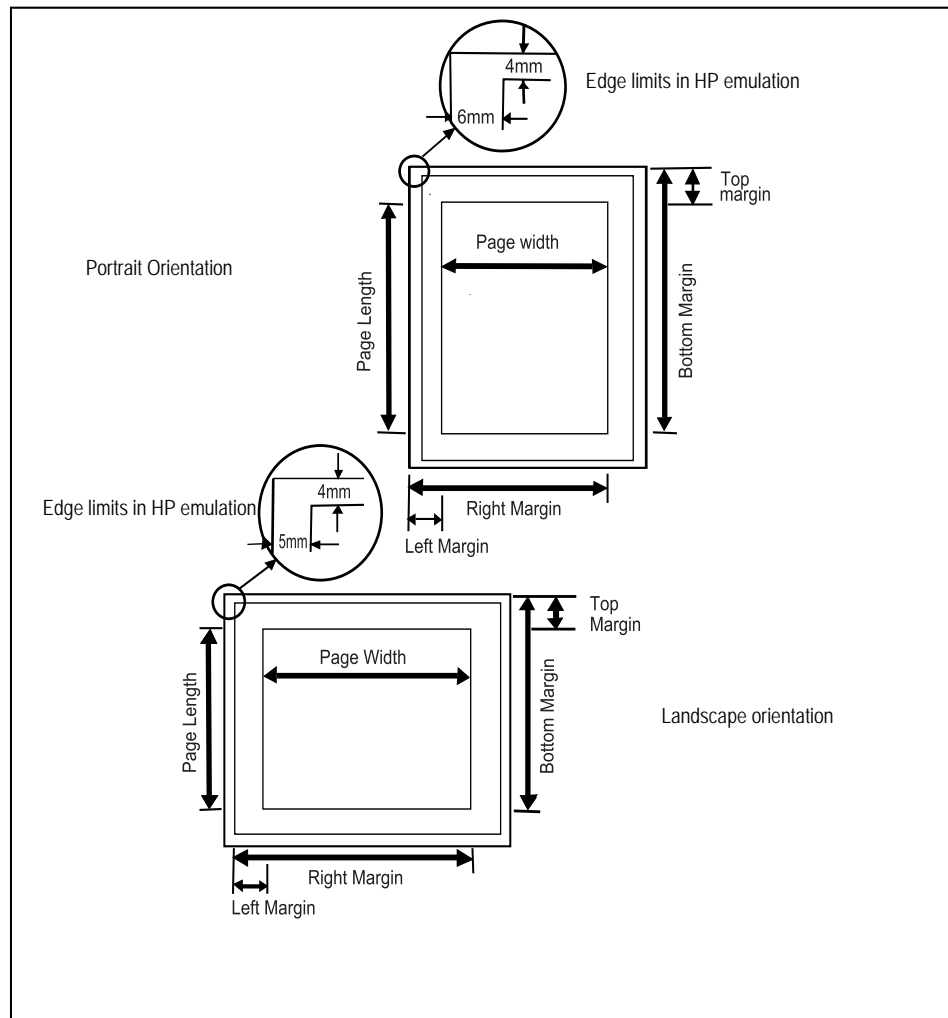

When the printing system passes the bottom margin while printing text, it prints the page and feeds to the next page. Spacing is carried over, so if the bottom margin does not occur at an exact number of lines, excess space is printed at the top of the next page.

If you are using word-processing software that sets the margins automatically, you should not set them with PRESCRIBE commands.

## Page Orientation and Direction

The term *page orientation* refers to the direction in which text is placed on the page. In a vertical direction, it would be called portrait and a horizontal direction would be called landscape. The term *print direction*, which follows this section, refers to the orientation of the logical page's coordinate system with respect to the current page orientation.

## Page Orientation

Changing the page orientation automatically adjusts the margins so that they remain the same distance from the four edges of the paper. If the printing system cannot make these margin settings (for example, if the left margin would be to the right of the right margin), it sets the margins to the edge limits.

Fonts are automatically rotated to match the current orientation.

Figure 1.5. Page Orientations

Portrait Orientation

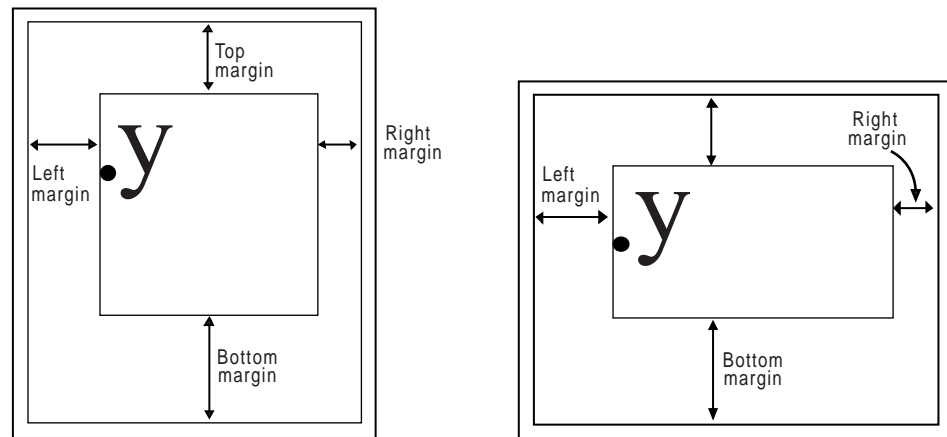

## Print Direction

The print direction can be modified in 90° increments. These page orientations are referred to as portrait, landscape, reverse portrait, and reverse landscape. Changing the print direction rotates the page coordinate system in the same manner as changing the page orientation. However, in this case, *portrait* refers to the print direction in which the axes of the coordinate system are oriented in the same direction as for the currently selected page orientation.

Changing the print direction also changes the margins to maintain the same printable area as prior to the change. The current position (the physical location in which the next character will be printed) and its coordinate values remain the same as in the previous print direction.

Changing the print direction also changes the orientation of any subsequent raster graphics and PRESCRIBE vector graphics. However, it does not affect the orientation of any subsequent HP-GL/2 graphics. (HP-GL/2 graphics can only be rotated with the HP-GL/2 RO command or the LaserJet orientation command.)

Figure 1.6. Print Direction

Portrait print direction

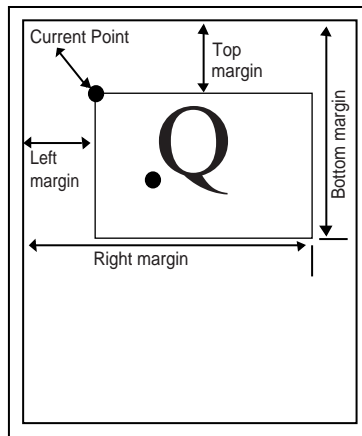

Landscape print direction

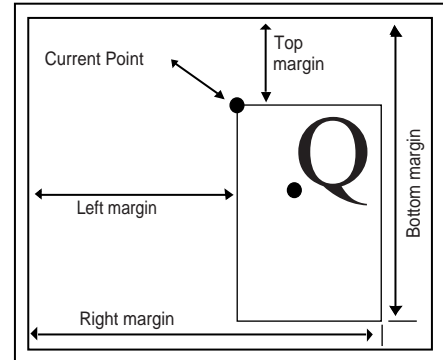

Reverse portrait print direction

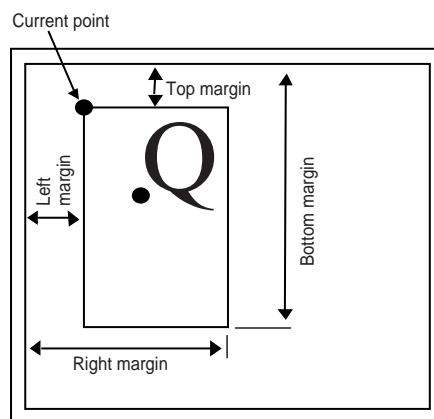

Reverse landscape print direction

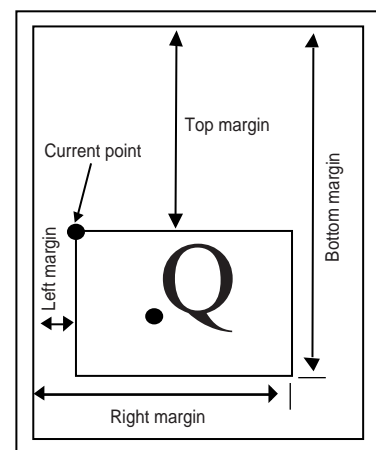

## Coordinate Systems

With PRESCRIBE, positions on a page are described in terms of  $X$  and  $Y$  coordinates. The origin of the coordinate system (the position at which  $X$  and  $Y$  both equal  $0$ ) is located at the intersection of the top margin and the left margin. Values of  $X$  greater than  $0$  indicate positions to the right of the origin, and values of  $Y$  indicate positions below the origin. See the figure on page 10. When the top and left margins are changed, the physical position of the origin changes accordingly.

## Text Positioning

The printing system always keeps track of its current position on the page. The current position can be thought of as a cursor that moves as data is printed. At any instant, the

cursor indicates where the next character will be printed or the next graphics will be drawn. (The printing system does not have separate cursors for text and graphics.)

Text and graphics can be positioned at arbitrary locations on the page by moving the cursor with positioning commands (MAP, for example).

Figure 1. 7. Text Positioning

```
TITLE  
!R! BOX 1, 1; MRP 2, 1;  
EXIT; LABEL
```

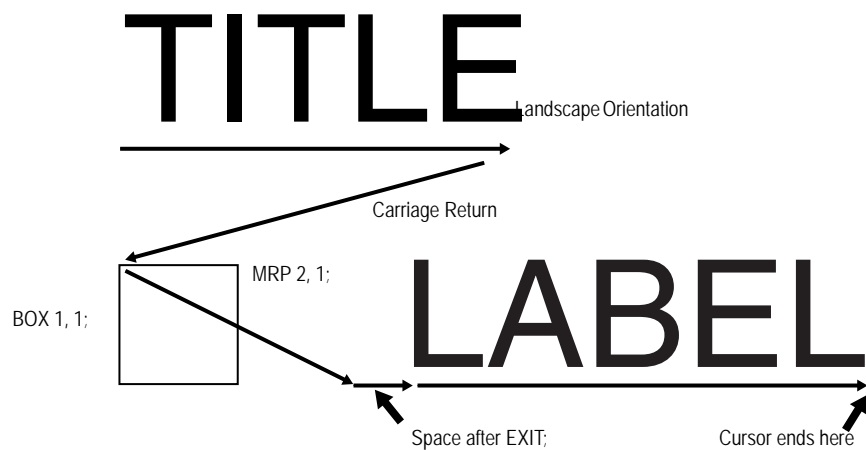

## Character Spacing

Each character is printed within an individual cell as shown below. The character sits on a line called the *baseline*. Characters such as *y* descend below the base line.

In some character fonts, all the character cells are the same size, so the number of character positions per inch is fixed. In other fonts, the size of character cells is proportional to the size of characters. These proportional fonts produce text that is easier to read. However, in order to align the right margin, you must use software that supports the printing system's proportional spacing.



Figure 1. 8. Character Spacing

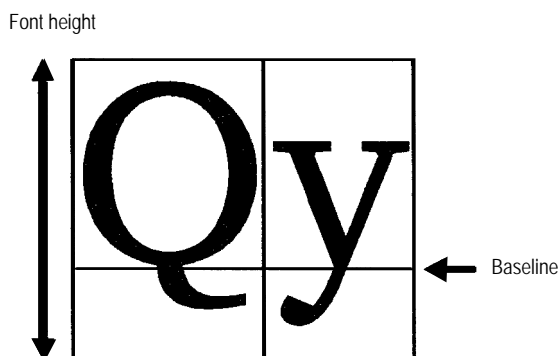

## Paths

A path is a set of straight and curved line segments. Paths can be open, as in the case of lines, or closed, as in the case of rectangles, circles, or any fully enclosed area of any shape. The segments may be connected with one another, or they may be disconnected. Further, a path may contain multiple closed *subpaths*, representing several areas, and they may intersect themselves in arbitrary ways.

Paths can be used to draw lines and curves or specify boundaries of filled areas, including the outline of a character.

Paths are explained more fully in section *Path Mode Graphics* on page 16.

## Logical Page and Physical Page

The logical page defines the limits of the coordinates within which text and graphics can be located. There are two types of logical page, as shown in the following figure. The standard mode logical page imposes limits on specifiable coordinates. The coordinates have no limitations for the path mode logical page.

Figure 1. 9. Logical Page and Physical Page

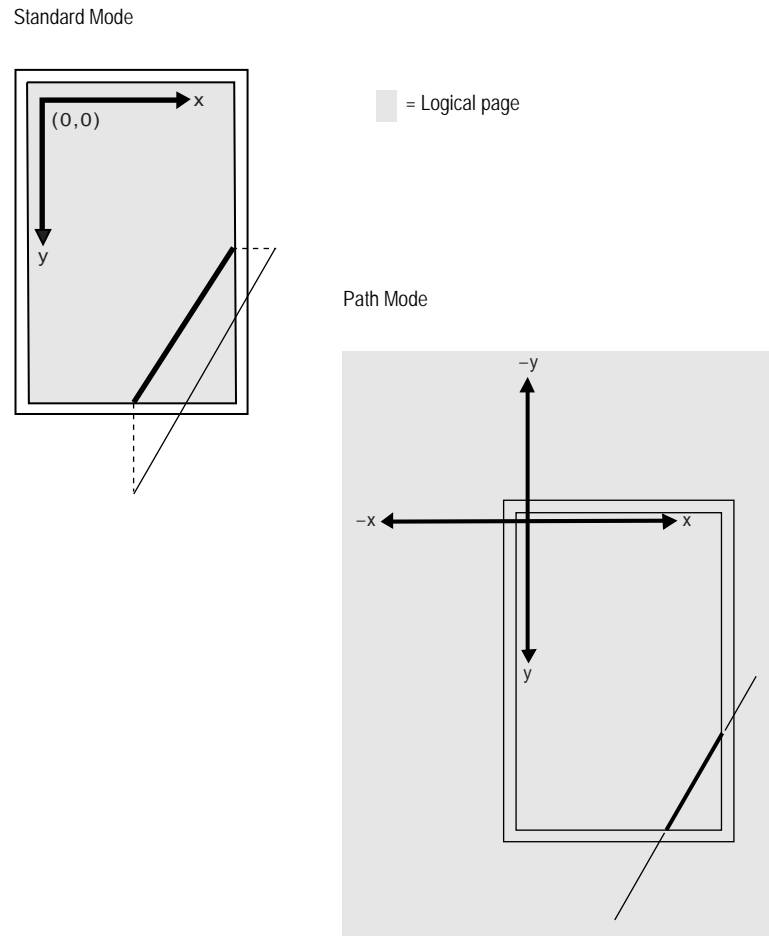

With the *standard mode* logical page, any position specification that lies outside of the logical limits is automatically adjusted to bring it within the limits. For example, the page on the upper left in the preceding figure shows what happens if you attempt to draw a diagonal line from below the bottom edge limit to a point to the right of the right edge limit when the standard mode logical page is used. The fine line represents the line as specified by the user; the thick line shows what is actually drawn by the printing system.

With the *path mode* logical page, coordinates are not adjusted even if they fall outside of the edge limits. In this case, as shown in the lower right page in the preceding figure, the line is defined by the specified starting and ending points, but parts falling outside of the edge limits are clipped.

## Command Parameters

### Numeric Parameters

Many of the PRESCRIBE commands use number values to specify parameters. For example, numbers are used to specify distances in inches, centimeters, points, or dots. Negative numbers are also allowed.

For computer code values beyond four decimal places, the fifth and subsequent decimal places are ignored.

Examples:

Number output by computer	Number used by printing system
1234.1234	1234.1234
-1234.1234	-1234.1234
0.123456	0.1234

Some commands have angle parameters. Angles are specified in degrees. (The printing system does not recognize radians). The printing system rounds off all angles to the nearest integral degree. Only angles in the range from -360 degrees to 360 degrees are recognized. Angles less than -360 degrees are ignored, and angles greater than 360 degrees are treated as the remainder of the angle divided by 360.

Examples:

Angle output by computer	Angle used by printing system (degrees)
90	90
-90	-90
90.4	90
90.5	91
-400	Ignored

The printing system does not accept the exponential notation used in some computer languages. For example, do not specify 1E-3 instead of 0.001.

## Character Strings

PRESCRIBE text-printing commands have parameters that consist of character strings. A character string is any string of characters enclosed by quotation marks or apostrophes, such as shown in the example below.

```
TEXT 'You are about to enter PRESCRIBE. ';
```

PRESCRIBE allows character strings to be enclosed in either single quotation marks (apostrophes) or double quotation marks. The following example has exactly the same meaning as the one above.

```
TEXT "You are about to enter PRESCRIBE. ";
```

The beginning of a character string is recognized when the first single or double quotation mark appears. If the beginning quotation mark is a single quotation mark, the string does not end until the next single quotation mark. If the beginning quotation mark is a double quotation mark, the string does not end until the next double quotation mark.

Whatever comes in the middle of a character string, including commas, semicolons, and even PRESCRIBE command names, is recognized as part of the character string, and not as part of the PRESCRIBE command language. For example, the expression EXIT; in the following string is just text; it does not cause the printing system to exit from the PRESCRIBE mode.

```
TEXT 'NO EXIT; NO RETURN. ';
```

When the string itself contains one type of quotation mark, the quotation mark must be enclosed in quotes of the other type. Here are two examples:

```
TEXT "You're about to enter PRESCRIBE.";  
TEXT ' " " " ';
```

In the first command above, the character string starts with a double quotation mark. The printing system therefore expects the string to end with a double quotation mark, and regards the apostrophe in the word *You're* as an ordinary character, not as the string terminator.

Similarly, the double quotation marks in the second command above are recognized as ordinary characters, not as string terminators.

Since an apostrophe or quotation mark can start a character string anywhere in a PRESCRIBE command sequence, it is important not to start character strings unintentionally. The following examples demonstrate incorrect use of apostrophes and double quotation marks.

Incorrect:

```
!R! CMNT Don't leave stray apostrophes; EXIT;
```

Incorrect:

```
!R! CMNT The symbol " means inches; EXIT;
```

In both of the above cases, the printing system assumes that the expression EXIT; is part of a character string started by the preceding apostrophe or quotation mark, and fails to exit the PRESCRIBE mode. The correct way to write these comments is:

Correct:

```
!R! CMNT "Don't leave stray apostrophes"; EXIT;
```

Correct:

```
!R! CMNT 'The symbol " means inches'; EXIT;
```

Character strings must not exceed the 255-character limit on total command length. If a character string exceeds this limit, the printing system terminates it forcibly and begins looking for the next PRESCRIBE command.

## Upper and Lowercase Letters

Regarding upper and lowercase characters, PRESCRIBE follows the same rule as many computer programming languages: it discriminates case inside character strings and ignores it elsewhere. You can type command names in upper or lowercase.

Correct:

```
!R! TEXT 'A'; CIR 1; EXIT;
```

Also correct:

```
!R! text 'A'; cir 1; exit;
```

Also correct:

```
!R! Text 'A'; Cir 1; Exit;
```

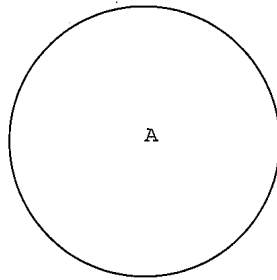

Each of these commands prints the capital letter ‘A’ inside a circle. In the printout shown above, the unit is centimeters. The reason that the letter ‘A’ is off center in the circle is that the cursor is not located at the center of the circle, but at left corner of the letter ‘A’.

The command

```
!R! TEXT 'a'; CIR 1; EXIT;
```

prints a lowercase *a* because the letter occurs inside a character string.

The sole exception to upper and lowercase usage in PRESCRIBE commands occurs with the initializing !R! command. This command must always use an uppercase R. The printing system will not enter the PRESCRIBE mode in response to !r!.

In this manual, PRESCRIBE commands are printed in upper-case for readability.

Outside of PRESCRIBE mode, the printing system always distinguishes between upper-case and lowercase letters and prints exactly what is sent.

## Special Parameters

Some PRESCRIBE commands use unquoted strings of characters as parameters. Examples for these are the FSET (change current font set by characteristic) command and the CSET (change symbol set by symbol-set ID) command. (See *Chapter 4* for a detailed explanation of how these commands are used to select fonts.)

The FSET and CSET commands use parameters that closely resemble the command parameters used for font control in Hewlett-Packard’s printer control language. For example, the PRESCRIBE command

```
FSET 0p12h12v0s0b6T;
```

selects the font whose characteristics most closely matches the following font parameters:

- Monospaced font (0p)
- Character spacing of 12 characters/inch (12h)
- Character height of 12 points (12v)
- Upright style (0s)
- Medium weight (0b)
- LetterGothicBM12-Roman typeface (6T)

In Hewlett-Packard’s PCL, the corresponding command would be

```
ESC(s0p12h12v0s0b6T
```

Similarly, the PRESCRIBE command `CSET 11U`; designates use of the PC-8 Danish/Norwegian symbol set. The corresponding Hewlett-Packard PCL command is `ESC ( 11U`.

# Graphics Tutorial

PRESCRIBE provides a wide variety of graphics operators, allowing you to easily construct and print almost any imaginable shape or pattern.

This chapter introduces the various graphics concepts of PRESCRIBE, and illustrates how to use many of its graphic functions. It defines standard graphics mode, path mode graphics, and raster graphics. It explains how to use predefined fill patterns, how to define your own fill patterns, and introduces ways in which you can change the *print model*, the rules that determine the manner in which patterns and images are rendered on the paper.

## Standard Graphics

The standard graphics mode provides a number of operators for constructing a variety of filled shapes and lines. Using standard mode graphics, you can:

- Draw lines of any desired width
- Draw circles and rectangles
- Draw a variety of filled shapes, including boxes and arcs
- Draw pie charts

This is referred to as the standard graphics mode because it is a standard feature of all versions of PRESCRIBE.

## Drawing Lines

PRESCRIBE provides a number of *Draw to* commands for drawing lines in both standard and path modes. These include:

DAP (draw to absolute position)	Draws a line to an absolute position in a Cartesian coordinate system whose origin (0,0) is at the intersection of the left and top margins.
DZP (draw to zero-relative position)	Draws a line to an absolute position in a Cartesian coordinate system whose origin (0,0) is at the intersection of the left and top edge limits of the paper.
DRP (draw to relative position)	Draws a line to a position specified as a horizontal and vertical displacement from the current cursor position.
DRPA (draw to relative position specified by angle)	Draws a line to a position that is specified as a distance and angle from the current cursor position. Examples of these commands are given in the sections that follow.

### *Lines to Absolute Position*

Begin with a simple task such as drawing a line between two arbitrary points on a page. Use the MAP and DAP commands to specify positions relative to the top and left margins.

This task has several distinct steps: selecting a line width, determining the starting point of the line, and determining the end point of the line. The following command sequence demonstrates this process.

```
!R! RES ;
    STM 0.5 ;
    SLM 0.5 ;
    SPD 0.01 ;
    MAP 0.5, 1 ;
    DAP 2, 0.5 ;
    PAGE ;
EXIT ;
```



Figure 2. 1. Result of Draw Commands: Absolute Lines

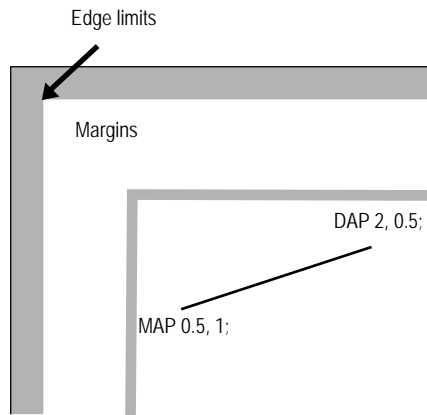

The initial !R! command switches the printing system to the PRESCRIBE mode. Remember that this command must always precede each sequence of PRESCRIBE commands.

The RES (RESet) clears the current page from printing system memory and re-establishes the printing system's permanent defaults. Although you would not include this command in every sequence of PRESCRIBE commands, we include it in this example to ensure consistent results. As a standard practice, include the RES at the beginning and end of each job.

The STM and SLM set both the top and left margins to 0.5 inches (1.27 centimeters).

The SPD (Set Pen Diameter) command determines the thickness of lines. In the standard graphics mode, this setting determines the thickness of all lines drawn after the command is issued. In this example, the line width is set to 0.01 inches.

The starting point of the line is established with the MAP (Move to Absolute Position) command. This command moves the cursor to a point that is a specified distance from the top and left margins. In this example, the point specified is 0.5 inches from the left margin and 1 inch from the top margin.

If the margins are changed, the position specified by MAP also changes correspondingly.

On the next line of the program, the DAP (Draw to Absolute Position) command draws a line from the starting position to the point 2 inches from the left margin and 0.5 inches from the top margin.

Finally, PAGE; prints out the page, allowing us to look at the result of our work.

## Zero-relative Lines

The line draw example below uses some new commands to draw another line.

```
!R! RES;  
    SPD 0.01;  
    MZP 0.5, 1;  
    DZP 2, 0.5;  
    PAGE;  
  
EXIT;
```

Figure 2. 2. Result of Draw Commands: Zero-relative Lines

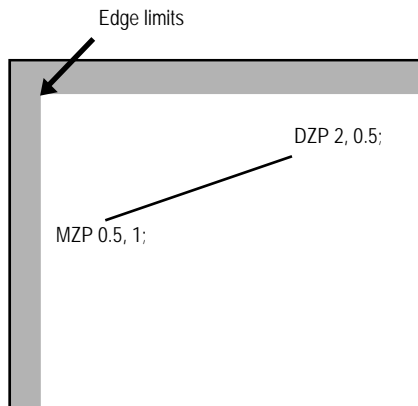

The first two lines switch the printing system to the PRESCRIBE mode, reset printing system parameters, and set the line width to 0.01 inch. On the third line, the MZP (Move to Zero-relative Position) differs from the MAP (Move to Absolute Position) command in one respect: the position specified is in relation to the top and left edge page limits of the page, rather than in relation to the top and left page margins. MZP moves the cursor to the point that is 0.5 inches from the left edge limit and 1 inch from the top edge limit. Similarly, on the next line, DZP (Draw to Zero-relative Position) draws a line from the starting position to the point 2 inches from the left edge limit and 0.5 inches from the top edge limit.

### Relative Lines

Another way to specify positions is in relation to the current cursor position. The following command sequence provides an example.

```
!R! RES ;
    SPD 0.01 ;
    MRP 2, 1 ;
    DRP -1.5, -1 ;
    MRP 2, 1 ;
    DRP -1.5, -1 ;
    MRP 2, 1 ;
    DRP -1.5, -1 ;
    PAGE ;
EXIT ;
```

Figure 2. 3. Result of Draw Commands: Relative Lines

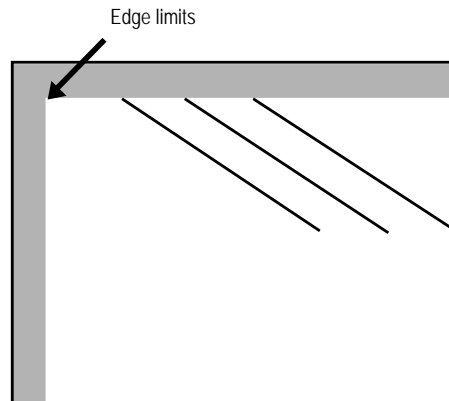

In this command sequence, the PRESCRIBE mode begins with the !R!, resets the printing system defaults to permanent settings with RES;, and establishes a pen width of 0.01 inches with the SPD 0.01;.

The MRP (Move to Relative Position) and DRP (Draw to Relative Position) specify positions in relation to the cursor's current position.

When the command sequence starts, the cursor is located at the intersection of the left and top margins. The command MRP 2, 1; on line 3 moves the cursor 2 inches to the right of its current position, and down 1 inch from its current position. Then the command DRP -1.5, -1; draws a line from that point to a point 1.5 inches to the left of the cursor position and 1 inch above it. The cursor winds up 0.5 inches to the right of the point where it started.

Lines 5 to 8 repeat the move-and-draw sequence two more times. This produces three parallel lines, as shown in the figure on the previous page.

### *Lines in Terms of Angles*

Until now, all of our examples have specified positions in terms of Cartesian (X,Y) coordinates. This example illustrates drawing lines of specified lengths and angles.

```
!R! RES;  
    SPD 0.01;  
    MZP 5, 4;  
    DRPA 2, 149;  
    DRPA 2, 221;  
    DRPA 2, 293;  
    DRPA 2, 365; CMNT Equivalent to 5 degrees;  
    DRPA 2, 437; CMNT Equivalent to 77 degrees;  
    PAGE;  
EXIT;
```

Figure 2. 4. Result of Draw Commands: Lines in Angles

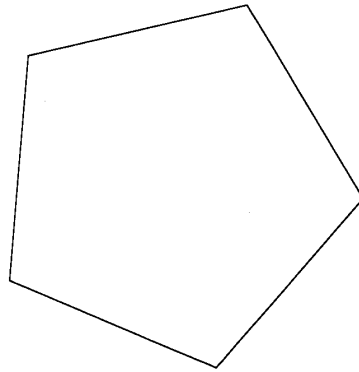

The first two lines of this command sequence initiates the PRESCRIBE mode, resets printing system defaults to permanent settings, and sets the line width to 0.01 inches. Then the MZP command on line 3 moves the cursor to a point 5 inches to the right of the left edge limit and 4 inches below the top edge limit.

Next, DRPA 2, 149; on line 4 draws a line two inches long at an angle of 149 degrees. The angle is measured clockwise from the vertical axis. The subsequent DRPA commands draw additional 2-inch lines at angles that increase in increments of 72 degrees. As indicated by the CMNT (CoMmeNT) commands, angles that exceed 360 degrees are equivalent to the remainder of division of the angle by 360.

## Drawing Boxes and Circles

PRESCRIBE provides two commands especially for drawing boxes (BOX command) and circles (CIR command).

### Drawing Boxes

The BOX (draw box) command draws a box of a specified *width* and *height*. As with the line drawing commands, the thickness of the line used to draw the box is determined by the SPD (set pen diameter) command.

The following command sequence draws a box.

```
!R! RES;  
    UNIT C;  
    SPD 0.1;  
    MZP 3, 3;  
    BOX 3, 4;  
    PAGE;  
EXIT;
```

Figure 2. 5. An Example of a Box

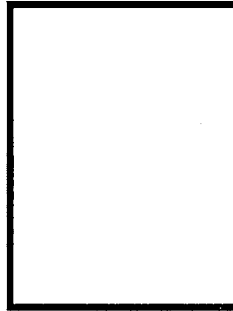

Line 1 places the printing system in the PRESCRIBE mode and resets printing system parameters. The UNIT C; command on the second line sets the unit of measurement to centimeters, and the SPD (Set Pen Diameter) command on line 3 sets the line width to 0.1 centimeters. (If you omit these two commands, the printing system will print using the default unit, inches; and the default line width, 3 dots.)

Next, the MZP command on line four moves the cursor to the point that is 3 centimeters to the right of the left edge limit and 3 centimeters below the top edge limit. This is the starting point from which the box is drawn.

On line 5, BOX 3, 4; draws a box with a width of 3 centimeters and a height of 4 centimeters.

The position of the box with respect to the cursor depends on the positive or negative value specified for *width* and *height*. The box is drawn to the right of the cursor if *width* is positive, and to the left of the cursor if *width* is negative. Similarly, the box is drawn below the cursor if *height* is positive, and above the cursor if *height* is negative. This relation is illustrated in the figure that follows.

By default, the position of the cursor is not affected by this command. However, you can also specify an *option* parameter to make the cursor move to an adjacent or diagonally opposite corner of the box, down by one text line, or to the left margin on the next text line. The following figure shows some examples.

Figure 2. 6. Cursor Positioning Options

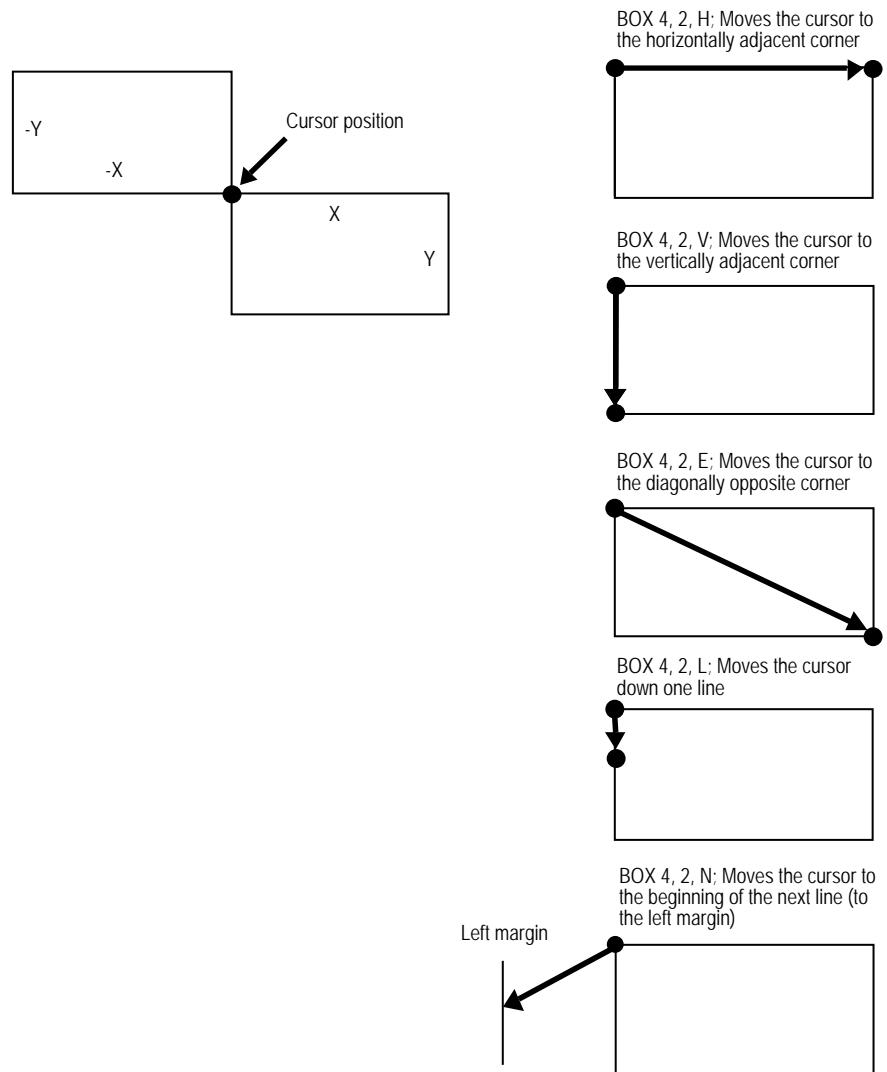

## Drawing Circles

The CIR (draw circle) command draws a circle of a specified radius using the line thickness set by the SPD (set pen diameter) command. The circle drawn is centered on the current cursor position; the position of the cursor remains unaffected. See the following example:

```
!R! RES;  
UNIT C;  
SPD 0.1;  
MZP 8, 8;  
CIR 1;  
CIR 2;  
CIR 3;  
PAGE;  
EXIT;
```

Figure 2.7. Circles

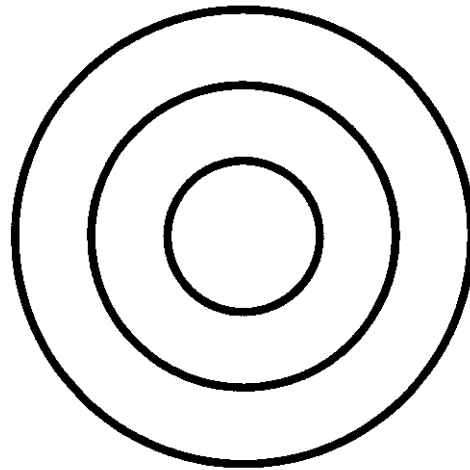

Lines 1, 2 and 3 start PRESCRIBE mode, reset the printing system to its default parameters, establish the unit of measurement as centimeters, and set the line width to 0.1 centimeters.

Next, the MZP command moves the cursor to the point that is 8 centimeters to the right of the left edge limit and 8 centimeters below the top edge limit.

Lines 5, 6, and 7 draw three circles with radii of 1, 2, and 3 centimeters.

## Drawing Filled Shapes

The standard graphics mode provides two types of filled shapes: arcs and blocks. Such shapes are filled with one of the printing system's predefined patterns, or with a user defined pattern.

Filled areas of other shapes can be printed using path mode graphics. For details, see the explanation in section *Path Mode Graphics* on page 16.

A filled block consists simply of a rectangle of any desired dimensions. A filled arc is an area enclosed by an arc segment and the line segments extending from the ends of the arc to the center of the circle of which the arc is a part.

This section shows how to select a fill pattern and print a filled block or arc.

### *Drawing Filled Blocks*

The following command sequence prints the block shown below.

```
!R! RES;  
  UNIT P;  
  MZP 72, 72;  
  PAT 6;  
  BLK 72, -144, H;  
  PAGE;  
EXIT;
```

*Figure 2.8. A Filled Block*

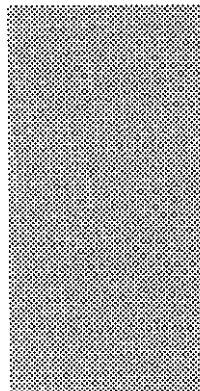

Lines 1 and 2 put the printing system in the PRESCRIBE mode, reset printing system parameters and set the unit of measurement to points. (One point is equal to  $1/72$  inches.)

Next, the MZP command moves the cursor to the position 72 points to the right of the left edge limit and 72 points below the top edge limit.

The PAT (select fill PATtern) command on line 4 of the program selects the fill pattern. In this program, pattern number 6 is selected.

You can select from among any of the printing system's 60 predefined fill patterns or choose to define a pattern using the XPAT (generate eXpanded PATtern) command. In either case, the selection is made with the PAT command. For 1200-dpi and 600-dpi models, the user can define the printing resolution (300, 600, 1200 dpi) of the pattern by giving a second parameter to the PAT command.

You can also select a shade of gray for filling the arc or block by using the GPAT (set Gray PATtern) command.

It is possible to apply a color to a pattern specified using PAT, FPAT, GPAT or XPAT. Note, however, that this may not always result in the exact same pattern as printed in monochrome.

The way a color looks may differ when used for different patterns even though the same color has been specified.



The BLK (draw filled-in BLock) command on line 5 actually draws the filled in block. This command closely resembles the BOX command explained in the preceding section. However, whereas the BOX command draws a line around a rectangular area, the BLK command fills a rectangular area with the currently selected pattern.

As with the BOX command, the position of the rectangular area with respect to the cursor depends on the sign of the values specified for width and height. The box is drawn to the right of the cursor if width is positive, and to the left of the cursor if width is negative; and the box is drawn below the cursor if height is positive, and above the cursor if height is negative.

As with the BOX command, you can specify an option parameter to make the cursor move to a specified location after the box is drawn. (The cursor remains unmoved if the option parameter is omitted.) Values for this option are H, V, E, L, N, and B, the same as for BOX.

## *Drawing Filled Arcs*

The ARC (draw filled-in ARC) command is similar to the BLK command (described in the preceding section) in that it fills an area with a pre-defined pattern or a shade of gray. The arc is drawn centered around the current cursor position. The dimensions of the arc are determined by user specified inner radius, outer radius, starting angle, and ending angle.

The following PRESCRIBE demonstrates the ARC command.

```
!R! CMNT Enter PRESCRIBE mode;
RES; CMNT Reset printing system parameters;
UNIT C; CMNT Set centimeters as unit;
PAT 9; CMNT Select pattern 9;
MZP 8, 8; CMNT Move cursor to point that is 8 cm;
      CMNT from left edge limit and;
      CMNT 8 cm from top edge limit;
ARC 1, 2, 0, 90;
PAGE;
EXIT;
```

*Figure 2. 9. A Filled Arc*

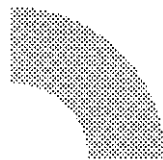

The ARC command on line 8 of the command sequence draws an arc with an inner radius of 1 centimeter, an outer radius of 2 centimeters, a starting angle of 0 (straight up), and an ending angle of 90 degrees.

The ARC command does not draw a line around the boundary of the filled-in area.

## Defining Fill Patterns

With a little work, you can construct your own fill patterns. You can generate  $8 \times 8$  dot patterns using the FPAT (generate Fill PATtern) command, or  $16 \times 16$  dot patterns using the XPAT (generate eXpanded fill PATtern) command. This section gives examples of both.

```
!R! RES;
    MZP 1, 1;
    FPAT 16, 40, 68, 130, 65, 34, 20, 8;
    BLK 1, 1;
    PAGE;
EXIT;
```

Line 4 of this command sequence prints a filled block using a fill pattern defined by the FPAT command on line 3.

Each of the eight numbers in the FPAT defines one row of an  $8 \times 8$  dot pattern. The pattern follows:

Figure 2. 10. Dot Pattern and a Filled Block

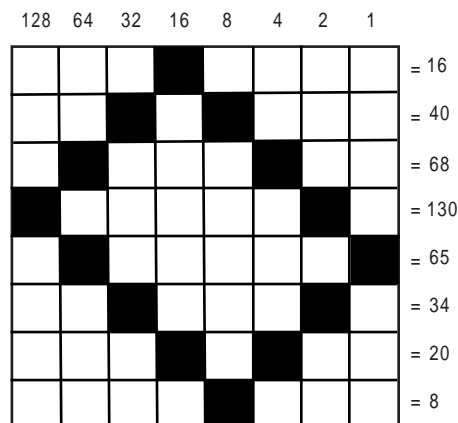

For this pattern, the numbers across the top indicate the value of each column. The numbers down the right side are the sums of the values of columns that contain black dots in that row.

Once this pattern has been defined by the FPAT command, it is used as the fill pattern until printing system parameters are reset with RES, another pattern is selected with PAT, a different pattern is defined with FPAT, or a shade of gray is defined and selected by GPAT.

Now let's look at an example using the XPAT command.

The XPAT command uses the format

```
XPAT pattern-number; bit map;
```

Note that the *pattern-number* parameter must be a value from 100 to 105 and followed by a **semicolon**, not a comma.

The following example demonstrates the XPAT command in a PRESCRIBE command sequence.

```

!R! RES;
  XPAT 100;
  @X0@ | 0Af0CC0FA8L@<X@6p@3p@3X@6L@<FA8CC0Af0@ | 0@X0;
  MZP 1, 1;
  PAT 100;
  BLK 1, 1;
  PAGE;
EXIT;

```

Lines 2 and 3 define the pattern shown in the figure on the next page, defining it as pattern 100. The PAT command on line 5 selects the pattern for use in fills. Line 6 prints the filled block.

Figure 2. 11. Dot Pattern and a Filled Block

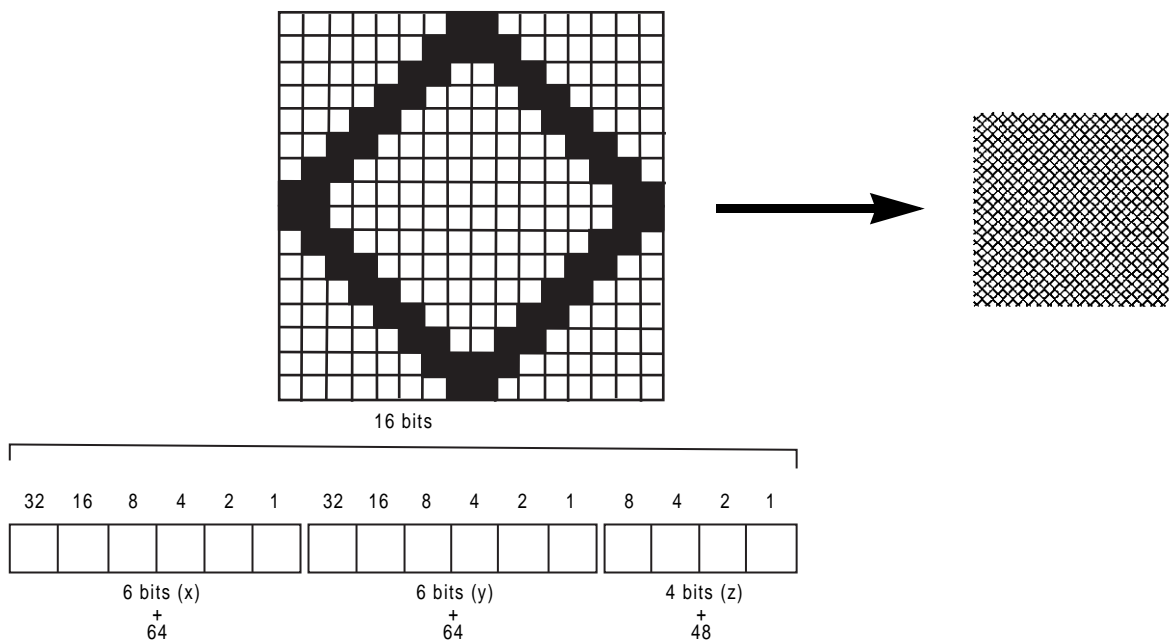

The pattern is 16 dots high and 16 dots wide, and is encoded as a series of 16-bit words. Each 16-bit word is encoded by three characters, representing the most significant six bits, the next six bits, and the least significant four bits, respectively, as shown on the next page.

You obtain the characters that define the pattern by dividing each row-work into sections of six, six, and four bits, calculating the numerical value of each section (referred to as  $x$ ,  $y$ , and  $z$ , respectively), treating it as a binary number in which the white dots are zeroes and the black dots are ones. Then add 64 (decimal) to the values of the 6-bit sections and 48 to the values of the 4-bit sections. The result is the ASCII code of the character that represents that section.

Column value

	0+64=64 (@) 24+64=88 (X) 0+48=48 (0)
	0+64=64 (@) 60+64=124 (!) 0+48=48 (0)
	1+64=65 (A) 38+64=102 (f) 0+48=48 (0)
	3+64=67 (C) 3+64=67 (C) 0+48=48 (0)
	6+64=70 (F) 1+64=65 (A) 8+48=56 (8)
	12+64=76 (L) 0+64=64 (@) 12+48=60 (<)
	24+64=88 (X) 0+64=64 (@) 6+48=54 (6)
	48+64=112 (p) 0+64=64 (@) 3+48=51 (3)
	48+64=112 (p) 0+64=64 (@) 3+48=51 (3)
	24+64=88 (X) 0+64=64 (@) 6+48=54 (6)
	12+64=76 (L) 0+64=64 (@) 12+48=60 (<)
	6+64=70 (F) 1+64=65 (A) 8+48=56 (8)
	3+64=67 (C) 3+64=67 (C) 0+48=48 (0)
	1+64=65 (A) 38+64=102 (f) 0+48=48 (0)
	0+64=64 (@) 60+64=124 (!) 0+48=48 (0)
	0+64=64 (@) 24+64=88 (X) 0+48=48 (0)

If the character resulting for section  $x$  of any row is @ (indicating that all bits in that section are white), then that character may be omitted. If sections  $x$  and  $y$  are both @, then both characters may be omitted. However, if the result for section  $y$  is @ and that for section  $x$  is a character other than @, then no characters may be omitted. In terms of the program example above, what this means is that the bit map string,

```
@X0@ | 0Af0CC0FA8L@<X@6p@3p@3X@6L@<FA8CC0Af0@ | 0@X0;
```

may be shortened by four characters to:

```
X0 | 0Af0CC0FA8L@<X@6p@3p@3X@6L@<FA8CC0Af0 | 0X0;
```

Patterns defined by the XPAT command remain effective until they are redefined by another XPAT command, or until the printing system is turned off.

## Drawing Pie Charts

The standard graphics mode provides a convenient function for drawing pie charts. See the following example:

```
!R! RES; UNIT C; SPD .05;
MZP 10, 10;
PIE 2, 0, 10, 20, 30, 40;
PAGE;
EXIT;
```

Figure 2. 12. PIE Example

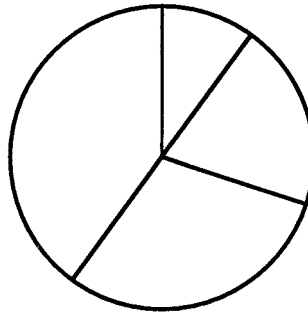

The PIE command uses the format

`PIE radius , starting angle , size of slice , ... ;`

In the example above, the *radius* is 2 centimeters (since we set the unit to centimeters with the UNIT command), and the starting angle is 0 degrees. Four pie slices are specified, with sizes of 10, 20, 30, and 40.

The printing system automatically converts the slice sizes to angles totalling 360 degrees. Then it draws the first slice with a cut at the angle specified by the second parameter (0 degrees in our example, or straight up). The remaining slices are drawn in sequence clockwise around the circle. The line thickness used for drawing the circle and the lines between slices are designated by the SPD (Set Pen Diameter) command.

Any number of pie slice sizes can be specified, provided that the total length of the command does not exceed 255 characters, and that the sum of the pie slices does not exceed 9999. All numbers specified for slice sizes must be non-negative integers.

The PIE command does not fill in the slices with any fill pattern. The PAT command can be used to create shaded areas. The previous example is expanded to fill in the slices.

```
!R! RES; UNIT C; SPD .1;
  MZP 10, 10;
  PAT 19; ARC 0, 2, 0, 36;
  PAT 41; ARC 0, 2, 36, 108;
  PAT 43; ARC 0, 2, 108, 216;
  PAT 48; ARC 0, 2, 216, 360;
  PIE 2, 0, 10, 20, 30, 40;
  PAGE;
EXIT;
```

Figure 2. 13. Pattern Filled PIE

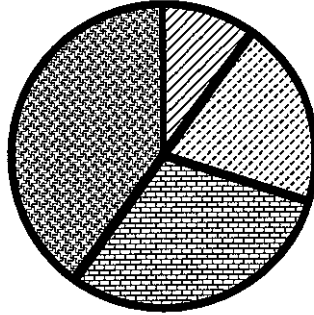

This program first draws four filled arcs, each using a different fill pattern, then prints the pie chart over the arcs. Each arc has an inner radius of zero, an outer radius of 2 (the same as the pie chart), and a starting angle and ending angle that correspond to the relative size of the pie slices. Since the total size of the pie slices in the example is 100 (10+20+30+40), the angular extent of each arc is equal to  $360 \times \text{size of slice} / 100$ . For example, the angular extent of the first arc is  $360 \times 10 / 100 = 36$  degrees. The starting angle of each arc equals the starting angle of the pie chart (0 degrees), plus the angular extent of all the preceding arcs. The ending angle equals the starting angle plus the angular extent of the arc.

## Path Mode Graphics

With path mode graphics, images are constructed by defining lines and curves as *paths*, then rendering them as images by stroking along the paths or filling the area enclosed by them. PRESCRIBE provides a variety of path construction operators and painting operators for stroking or filling paths.

### Path

In PRESCRIBE, a path is a set of straight or curved line segments, either connected or disconnected, that describes the shape and position of one or more objects or regions. Paths can be used to draw lines and curves and to specify boundaries of filled areas.

A path is *stroked* by drawing a line of arbitrary width along it. The line may be solid black, all white, or any intermediate shade of gray. It may also be a dashed line of any pattern of segment lengths.

A path is *filled* by painting the entire area that it encloses with a gray scale pattern, ranging from black to white, or with one of the printing system's predefined patterns. In order to be filled, a path must be closed; that is, it must return to its starting point.

A path is constructed by means of one or more *path construction* operators. The path construction operators modify the current path, usually by appending to it. However, a path in itself does not produce any image on the page. Once a path has been constructed, it can be used to control the application of one of the painting operators of PRESCRIBE, defining the boundary of the area in which images can be printed.

There are no restrictions on the shape of a path. A single path may include multiple *closed* subpaths, representing several areas, and a path may intersect itself in an arbitrary manner.

The order of the segments that define a path is significant. A pair of line segments is said to connect only if they are defined consecutively, with the second segment starting where the first one ends. Non-consecutive segments that meet or intersect fortuitously are not connected.

A subpath is a sequence of connected segments. A path is made up of one or more subpaths. Subpaths may be either open or closed.

Path construction begins with a NEWP (NEW Path) command. Path construction ends with the CLSP (CLoSe Path) command or with any paint operator that paints the region enclosed by the path or draws a line along it (such as STRoKe or FILL).

## Drawing Lines

The following example shows how to draw a line in the path mode.

```
!R! RES ;
    NEWP ;
    PMZP 1, 1 ;
    PDZP 2, 3 ;
    STRK ;
    PAGE ;
EXIT ;
```

Figure 2. 14. Drawing Lines in Path Mode

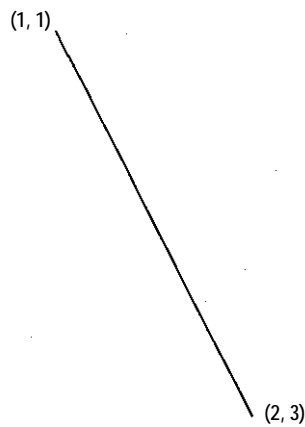

Line 1 of the program switches the printing system to the PRESCRIBE mode and resets printing system parameters, including the unit (to inches), line width (to 3 dots), and various other aspects of the graphics state.

Path construction begins with the NEWP command on line 2. This command empties the current path (if any), making it possible to start a new one. In doing so, it makes the position of the cursor undefined.

The PMZP (Path, Move to Zero-relative Position) command on line 3 moves the cursor to a position one inch from the top and left edge limits of the paper. The coordinates specified may be positive or negative.

On line 4, the PDZP (Path, Draw to Zero-relative Position) draws a line from the current cursor position to the position 2 inches from the left edge limit and 3 inches from the top edge limit. The cursor remains at this position after the line is drawn.

On line 5, the STRK command strokes the path onto the page.

After stroking the current path, the STRK command clears the path in the same manner as NEWP (start NEW Path).

Finally, PAGE prints out the page, allowing us to look at the result of our work and cancelling all changes made during the course of the program, then EXIT ends the PRESCRIBE mode.



## Two Lines

The preceding example illustrated construction of a path between points specified in terms of absolute coordinates. The following program draws two lines, using both absolute coordinate specification and a new method: relative coordinate specification.

```
!R! RES;
  NEWP;
  PMZP 1, 1;
  PDZP 2, 3;
  PMRP .5, -1;
  PDRP -1, -1;
  SPD 0.04;
  STRK;
  PAGE;
EXIT;
```

Figure 2. 15. Drawing Two Lines

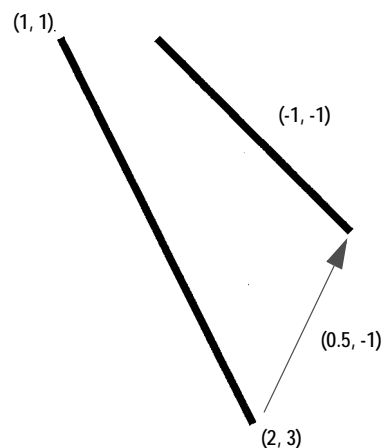

The first four lines of this program are identical to the preceding example. Line 1 switches the printing system to the PRESCRIBE mode and resets printing system parameters, line 2 empties the current path, and lines 3 and 4 draw a line between two points that are specified in terms of absolute coordinates.

On line 5, the PMRP (Path, Move to Relative Position) command moves the cursor to the point half an inch to the right and one inch above the current cursor position; that is, the point at which the first line ends. Then the PDRP (Path, Draw to Relative Position) command on line 6 draws a line to the point 1 inch to the left of the new position and 1 inch below it.

The line thickness is changed to 0.04 inches by the SPD command on line 7.

Finally, the STRK command on line 8 strokes the path onto the page, PAGE prints out the page, and EXIT ends the PRESCRIBE mode.

## Line Ends

The line end type determines how PRESCRIBE renders the ends of lines when they are stroked onto the page. PRESCRIBE provides three kinds of line ends. These include:

Figure 2. 16. Line Ends

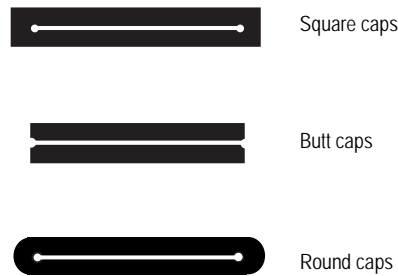

The default line end type is butt caps. You can switch from the current line end type to any of the other types with the SCAP command. This command uses the following format:

```
SCAP line-cap mode ;
```

Values for *line-cap mode* include:

- 1 (for square caps)
- 2 (for butt caps)
- 3 (for round caps)

Use of this command is illustrated in the following example.

```
!R! RES;
  UNIT C; CMNT Sets unit to cm;
  NEWP; CMNT Starts new path;
  SPD .5; CMNT Sets line width to .5 cm;
  SCAP 1; CMNT Sets square caps;
  PMZP 2, 2;
  PDZP 4, 4;
  SCAP 3; CMNT Sets round caps;
  STRK;
  PAGE;
EXIT;
```

Figure 2. 17. Printout of SCAP Example

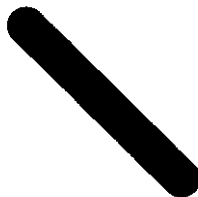

Note that the line is rendered with round caps, rather than with square ones. Although square caps is set before constructing the path, the line type is changed to round prior to

stroking the path. PRESCRIBE refers to the line cap type when the current path is stroked onto the page, rather than while the path is being constructed. Therefore, the program above renders the line with round caps rather than square ones.

## Line Joins

When a path consists of multiple connected line segments, the manner in which they are stroked onto the page depends on the current *line join* type.

PRESCRIBE provides four types of line joins. These are called *beveled*, *mitered*, *round*, and *notched*. These are illustrated below.

Figure 2. 18. Joins

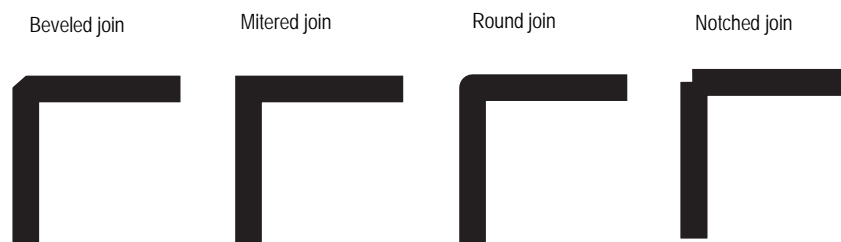

The default line join type is beveled. With beveled joins, connected line segments end with butt caps, and the notch at the larger angle between the segments is filled with a triangle.

With mitered joins, the edges of connected line segments are extended until they meet. This type of join is limited by the *miter limit* (explained below).

With round joins, connected line segments are joined with circular caps.

Notched joins leave a notch at the larger angle between the connected line segments.

You can switch from the current line join type to any of the other types with the SLJN (Set Line JoiN) command. This command uses the following format:

```
SLJN line-join mode ;
```

Values for *line-join mode* include:

- 1 (for beveled joins)
- 2 (for mitered joins)
- 3 (for round joins)
- 4 (for notched joins)

## Miter Limit

When using mitered line joins, the use of such joins is limited by the *miter limit*. The miter limit is the maximum ratio of the distance  $l$  between the inner and outer corners of a mitered join and the width  $w$  of the lines joined.

Figure 2. 19. Miter Limit

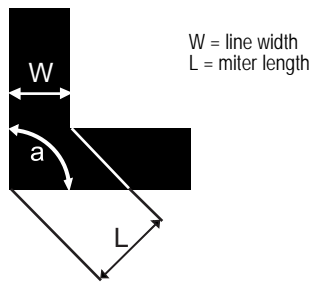

Miter limit = maximum ratio of  $L/w = 1/\sin(a/2)$

If the angle at which lines join is such that this limit is exceeded, the lines are joined with a beveled join, rather than a mitered one.

The purpose of the miter limit is to prevent objectionably long spikes when lines join at small angles. The default miter limit is 10, which results in beveled joins at angles of less than about 11.5 degrees.

You can set any desired miter limit with the **SMLT** (Set Miter LimiT) command. This command has the following format.

```
SMLT limit-value ;
```

Here are some representative *limit-values* and the corresponding angles at which the line join type switches between mitered and beveled.

limit-value	approx. angle
2	60
3	39
4	29
5	23
6	19
7	16
8	14
9	13

## Dash Type

By default, the STRK command strokes paths with solid lines. However, you can also use a predefined pattern of alternating black and white to stroke paths. This makes it possible to stroke paths as dashed lines. You can also define your own dashed line patterns.

The DPAT (select Dash PATtern) command selects one of PRESCRIBE's ten predefined dash patterns, or one of 10 dash patterns that you can define yourself. This command uses the format:

```
DPAT pattern-number ;
```

The following program illustrates use of this command.

```
!R! RES;
    UNIT C; CMNT Sets unit to cm;
    NEWP; CMNT Starts new path;
    SPD .5; CMNT Sets line width to .5 cm;
    PMZP 2, 2;
    PDZP 4, 4;
    DPAT 5;
    STRK;
    PAGE;
EXIT;
```

Figure 2. 20. Printout of the DPAT Example



In this program, the DPAT command selects the dash pattern with which the line is stroked.

Predefined dash patterns are selected by specifying values from 1 to 10 for pattern-number. (A value of 1 specifies solid lines.) User-defined patterns can be selected by specifying values from 11 to 20. The next section explains how to use the SDP (Store Dash Pattern) command to define your own dash patterns. Specifying an undefined user pattern number results in solid black lines.

## User Defined Dash Patterns

Using the SDP command, you can define your own dashed patterns for use in stroking lines, arcs, and curves. See the following example:

```
!R! RES;
    UNIT P;
    SDP 11, 2, 2, 5, 2;
    UNIT C; CMNT Sets unit to cm;
    NEWP; CMNT Starts new path;
    SPD .5; CMNT Sets line width to .5 cm;
    PMZP 2, 2;
    PDZP 4, 4;
    DPAT 11;
    STRK;
    PAGE;
EXIT;
```

Figure 2. 21. Printout of the SDP Example



The SDP command on line 3 defines a dashed pattern consisting of two lengths of black, two lengths of white, five lengths of black, and two lengths of white. On line 11, the DPAT command selects this pattern for stroking. The path defined by the PMZP (Path, Move to Zero-relative Position) and PDZP (Path, Draw to Zero-relative Position) commands is stroked using this pattern, with a result as shown in the figure above.

The SDP command uses the general format:

```
SDP pattern-number, dash1, space1, dash2, space2, ..., dash10, space10;
```

The value specified for *pattern-number* must be in the range from 11 to 20. Dash and space lengths are specified in pairs. Up to ten dash-space pairs can be specified. The dash length always comes first in each pair. If a pattern is to begin with a space, then specify 0 for *dash1*. However, if a pattern ends with a dash, the following *space* parameter can be omitted.

Dash patterns defined with this command remain valid until redefined with another SDP command, or until the printing system is turned off.

## Drawing Arcs and Curves

A path can include curves as well as lines. The PARC (Path, draw ARC) and PCRCP (Path, Curve to Relative Position) commands make it possible to draw circular arcs and arcs of more complex form.

The PARC command uses the format:

```
PARC x, y, radius, ang1, ang2;
```

where *x* and *y* describe the zero-relative coordinates of the center of the arc, *radius* describes the radius of the arc, *ang1* describes the arc's starting angle, and *ang2* describes the arc's ending angle. Coordinates and radius are measured in the unit currently designated by the UNIT command, and the starting and ending angles are measured clockwise from the positive *x* axis.

The PARC command draws a line between the cursor position and the beginning of the arc. See the following example:

```
!R! RES; UNIT C; NEWP; SPD .1;
  PMZP 5, 5;
  PARC 5, 5, 3, 45, 135;
  STRK;
  PAGE;
EXIT;
```

Figure 2.22. Printout of the PARC Example

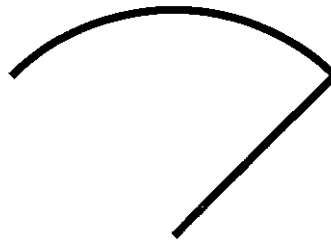

After the arc is drawn, the cursor is located at the end of the arc.

If you wish to eliminate the straight line segment in the above example, leaving only the arc, the cursor position must be moved in advance to the position at which drawing of the arc begins. This is shown in the following example, in which the cursor is moved to the coordinates as specified by the PMRA (Path, Move to Relative position specified by Angle) command prior to drawing the arc.

```
!R! RES UNIT C; NEWP; SPD .1;
    PMRA 5, 5, 3, 45;
    PARC 5, 5, 3, 45, 135;
    STRK;
    PAGE;
EXIT;
```

In this current example, the PMRA command moves the cursor from coordinates 5, 5, as measured from the left and top edge limits of the page, through the distance of 3 centimeters at the angle of 45 degrees from the positive x axis. At this point, the PARC command starts to draw the arc which ends at the angle of 135 degrees.

Figure 2.23. Printout of the PMRA Example



Circles can be constructed by drawing arcs with angular extents of 360 degrees. To draw a circle, you will also need a PMRA command to eliminate the line extending from the center of the circle to the beginning of the circle. See the following example:

```
!R! RES; UNIT C; NEWP; SPD .1;
    PMRA 3, 3, 1.5, 0;
    PARC 3, 3, 1.5, 0, 360;
    STRK;
    PAGE;
EXIT;
```

Figure 2. 24. Printout of a Circle Made with PMRA

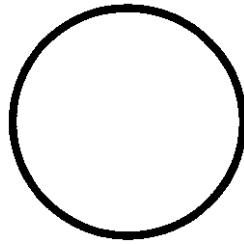

## Drawing Complex Curves

PRESCRIBE also provides a second curve-drawing operator for constructing complex curves that are referred to as *Bézier* curve segments. The PCRCP (Path, Curve to Relative Position) uses the following format.

PCRCP  $x1, y1, x2, y2, x3, y3;$

Figure 2. 25. Bézier Curves

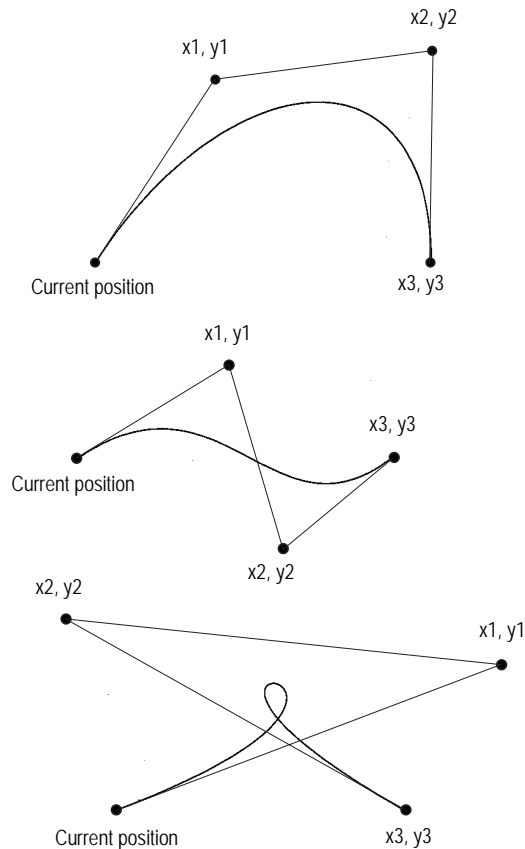

A Bézier curve segment is one that is geometrically defined by a starting point (the cursor's current position), two control points ( $x1, y1$  and  $x2, y2$ ), and an ending point ( $x3, y3$ ). Coordinates of each of these points are specified as an offset from the cursor's previous position.



The curve leaves the current position in the direction of  $x1, y1$ , and is tangent to the line between the current position and  $x1, y1$ . It bends towards  $x2, y2$ , then to  $x3, y3$ , and at the end point, is tangent to the line between  $x2, y2$  and  $x3, y3$ . The curve is always entirely enclosed by the complex quadrilateral defined by the starting point,  $x1, y1$ ,  $x2, y2$ , and  $x3, y3$ .

See the following examples:

```
!R! RES; UNIT C; NEWP; SPD .1;
    PMZP 3, 3;
    PCRP 4, 2, 5, 1.5, 6, 1.8;
    STRK;
    PAGE;
EXIT;
```

Figure 2. 26. Printout of the PCRP Example

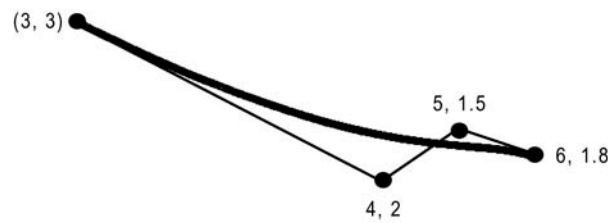

```
!R! RES; UNIT C; NEWP; SPD .1;
    PMZP 3, 3;
    PCRP 5.5, 1.5, 1.5, 5.5, 7, 7;
    STRK;
    PAGE;
EXIT;
```

Figure 2. 27. Second PCRP Example

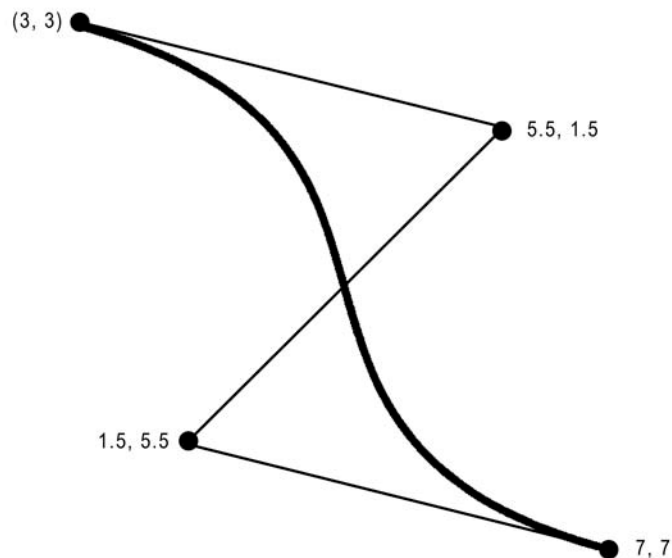

```
!R! RES; UNIT C; NEWP; SPD .1;  
  PMZP 3, 4;  
  PCRP 4, 2, 5, 4, 6, 2;  
  STRK;  
  PAGE;  
EXIT;
```

Figure 2. 28. Third PCRP Example

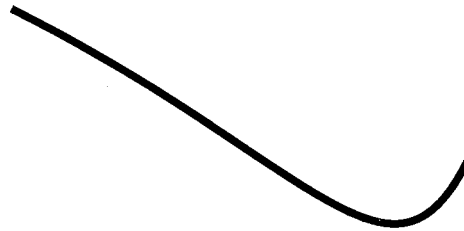

### Setting the Flatness of Curves

When PRESCRIBE renders any curve, it actually converts the curve to a series of connected straight line segments. The length of these line segments is referred to as a curve's *flatness*. You can change the degree of flatness with the FLAT (set FLATness) command. The default flatness is 1 (dot). Setting smaller values of flatness results in smoother curves, but more time is required for computing the larger number of line segments involved. (The difference is not noticeable for a single curve, but can be substantial in highly complex pages. Also, the difference is more noticeable with lower print resolutions [for example, 300 dpi resolution].)

The following programs illustrate the results of setting the flatness to higher values.

```
!R! RES; UNIT C; NEWP; SPD .1;  
  FLAT 30;  
  PMZP 5, 5;  
  PCRP 4, 2, 5, 4, 4, 0;  
  STRK;  
  PAGE;  
EXIT;
```

Figure 2. 29. Curve with Flatness 30

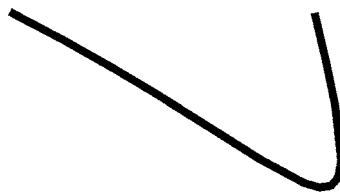

```

!R! RES; UNIT C; NEWP; SPD .1;
  FLAT 60;
  PMZP 5, 5;
  PCRP 4, 2, 5, 4, 4, 0;
  STRK;
  PAGE;
EXIT;

```

Figure 2. 30. Curve with Flatness 60

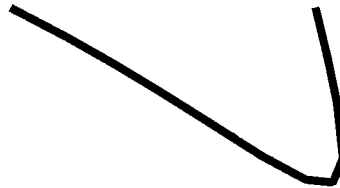

Both of these programs draw an identical curve. The only difference between the two is in the flatness, which is specified on line 2.

## Closed Paths

When the end point of a path connects to its starting point, the path is said to be *closed*. A closed path can be stroked, in the same manner as an open path, or it can be filled with gray-scale shading or a standard mode fill pattern.

Simply ending a path at the path's starting point does not make it a closed path; such a path remains open until it is closed. Closure can be done either explicitly, by means of the CLSP (CLoSe current Path) command, or implicitly by means of the FILL command.

The following example illustrates construction and closure of a path.

```

!R! RES; UNIT C; NEWP; SPD .5;
  PMZP 4, 2;
  PARC 3, 3, 1, 90, 270;
  PARC 5, 3, 1, 270, 90;
  CLSP;
  STRK;
  PAGE;
EXIT;

```

In this example, the PMZP command on line 2 places the current cursor at coordinates 4, 2, where the subsequent PARC command automatically starts to draw a line extending to the beginning of the arc. The PARC command then draws an arc from 90 degrees (straight up) to 270 degrees (straight down) around the center at coordinates 3, 3. After the arc is drawn, the cursor is located at the end of the arc. Then the PARC command on line 4 draws an arc from 270 degrees to 90 degrees around the center at coordinates 5, 3. Because the cursor position is defined at the end of the first arc when construction of the second arc starts, the second PARC command draws a line between the end of the first arc and the beginning of the second one. Finally, the CLSP command on line 5 explicitly closes the path, thereby constructing a line between the end of the second arc and the beginning of the first one.

Now the path has been closed. The STRK command goes on to stroke the path, producing the shape shown below.

Figure 2. 31. A Closed Path

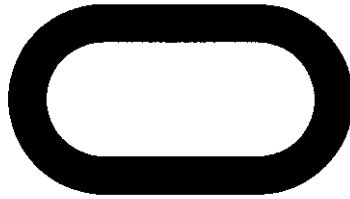

## Filled Areas

```
!R! RES; UNIT C;  
  NEWP;  
  GPAT .5;  
  PMZP 4, 2;  
  PARC 3, 3, 1, 90, 270;  
  PARC 5, 3, 1, 270, 90;  
  FILL 1;  
  PAGE;  
EXIT;
```

This program is similar to the previous one. In this case, we choose to fill the path instead of stroking it. We select a shade of gray for filling the path (.5, a value directly between black and white) with the GPAT (set Gray PATtern) command on line 3.

First, we construct the path by drawing arcs around the center points. However, we will not close it explicitly.

Then we execute the FILL command. This implicitly closes the path, drawing a line between the ending point of the second arc and the starting point of the first one, then fills the closed path with the selected gray scale pattern.

Note that we could have filled the path with a standard mode fill pattern instead of a gray-scale pattern. The only change necessary would be to replace the GPAT command on line 3 with a PAT or FPAT command specifying the pattern to be used.

The format of the FILL command is

```
FILL rule;
```

The *rule* parameter specifies the convention according to which the path is filled.

With simple convex paths such as that shown below, the entire enclosed area is filled.

Figure 2. 32. Simple Filled Paths

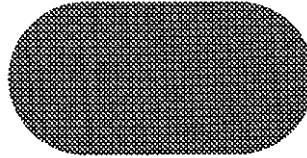

However, when a path consists of multiple closed subpaths or intersects itself as shown in the next two figures, the rule determines areas that are deemed to be inside the path.

```
!R! RES; UNIT C;
  PMZP 5, 5;
  PMRA 5, 5, 2, 0;
  PARC 5, 5, 2, 0, 360;
  PMRA 5.2, 5.2, 1.5, 0;
  PARC 5.2, 5.2, 1.5, 0, 360;
  PMRA 5.5, 5.5, 1, 0;
  PARC 5.5, 5.5, 1, 0, 360;
  FILL 1;

  PMZP 10.5, 4.5;
  PMRA 10.5, 4.5, 2, 0;
  PARC 10.5, 4.5, 2, 0, 360;
  PMRA 11, 6, 2, 0;
  PARC 11, 6, 2, 0, 360;
  PMRA 12, 5, 2, 0;
  PARC 12, 5, 2, 0, 360;
  FILL 1;
  PAGE;
EXIT;
```

Figure 2. 33. Complex Filled Paths

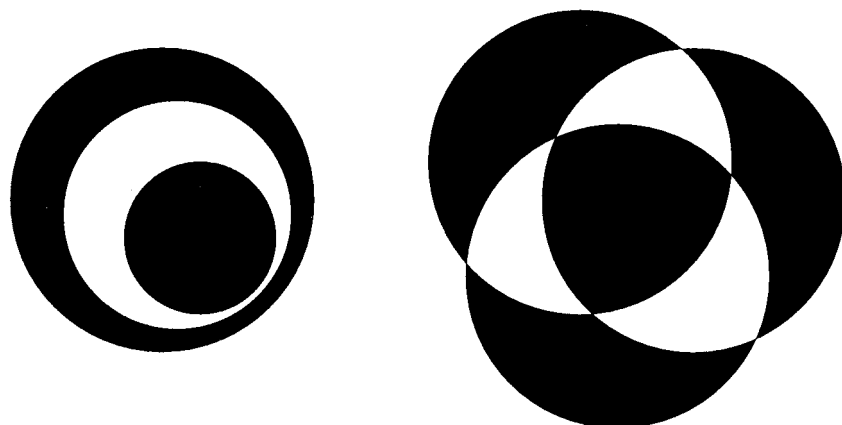

With 1 specified for the rule parameter of FILL, the method for determining whether a point is inside the path involves drawing a ray from that point in any direction and counting the number of times the ray crosses segments of the path. The point is said to be inside the path if the result is an odd number; if the result is an even number, the point is said to be outside the path.

The non-zero winding rule also draws a ray from a point in any direction to determine whether or not that point is inside the path and examines the points where a segment of the path crosses the ray. However, it then starts counting from zero and adds one each time a segment in the path crosses the ray from left to right; and subtracts one each time a segment in the path crosses the ray from right to left. If the result of counting all the crossings is zero, the point is said to be outside; otherwise the point is said to be inside the path.

After filling the current path, the FILL command clears the path in the same manner as NEWP.

## Clipping Rectangle

Up to this point, we have discussed graphics objects to be drawn or stroked or filled as paths. However, another PRESCRIBE command can be used to define a clipping template for clipping texts, paths, and raster graphics. For this purpose, the CLPR (CLiP Rectangular region) command is provided to define the rectangular region for clipping paths.

When the printing system is turned on or reset with PRESCRIBE's RES command, the clipping rectangle is identical to the printable limits of the page. Subsequently, executing the CLPR command reduces the clipping rectangle to the intersection of the objects on the page and the rectangle defined by CLPR.

The following is an example of CLPR.

```
!R! RES; UNIT C;  
  NEWP;  
  SPD 1;  
  PMRA 6, 9, 3, 0;  
  PARC 6, 9, 3, 0, 360;  
  CLPR 3, 6, 9, 12;  
  STRK;  
EXIT;
```

In this example, lines 1 through 5 draw a circle with an extra line thickness at the coordinates defined by the PMRA command.

The CLPR command on line 6 constructs a rectangle with its left-upper corner positioned at coordinates 3, 6 and its right-bottom corner positioned at coordinates 9, 12 (both measured from the top and left edge limits of the page).

As with the rectangular area clipping, those parts of the circle that lie outside of the clipping rectangle are erased when the path is stroked, producing the result as shown in the figure on the next page.

The rectangle defined by CLPR does not clip the graphics objects which are drawn by the standard mode graphics commands.

Figure 2. 34. Clipping Rectangle Example

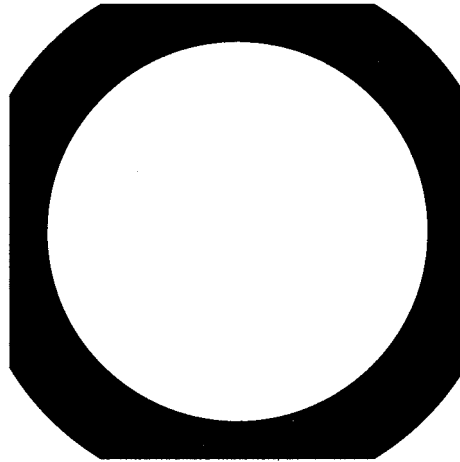

## Printing with Character Paths

When a resident scalable (outline) font is selected, you can treat a character as a path and add it to the current path. The PRESCRIBE command is CPTH (Character PaTH).

Paths created with the CPTH command can be either stroked or filled. See the following example.

```
!R! RES;
    UNIT P;
    NEWP;
    PAT 26;
    SFNT 'Helvetica-Bd', 54;
    PMZP 72, 144;
    CPTH "xyz";
    FILL 1;
    PAGE;
EXIT;
```

Figure 2. 35. Character Path

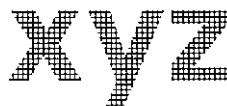

Line 2 of this program sets the unit to printing system's points (1 point= 1/72 inch), then the NEWP command on line 3 empties the current path (if any), making ready for construction of a new path. The PAT command on line 4 selects predefined pattern number 26 as the current fill pattern.

Next, the SFNT (Select current FoNT by typeface) on line 5 selects Helvetica Bold, a scalable (outline) font as the current font and scales the font to a height of 54 points. Use of SFNT and other font selection commands are explained more fully in *PRESCRIBE Commands Command Reference*.

The PMZP command on line 6 moves the cursor to the point that is 72 points (1 inch) from the left edge limit and 2 inches from the top edge limit.

The CPTH command on line 7 constructs a path using the outline of the characters in the string *xyz*. The cursor is moved to the end of the string.

Finally, the FILL command fills the path with the selected pattern, and PAGE prints out the page.

## Raster Graphics

While the graphics commands of the standard and path modes draw shapes such as lines, circles, and boxes, raster graphics commands specify individual dots to draw images. The dot resolution is selectable from 75 to 300 dots per inch for all models; and 600-dpi models have two more choices of 200 dpi and 600 dpi. Lower resolutions give a rougher appearance, but require less raster data for an image of a given size.

Raster graphics are limited in size only by the dimensions of the paper, and in complexity only by the dot resolution.

## Raster Data Compression Formats

PRESCRIBE supports raster data in three formats: uncompressed raster data, run-length encoded raster data, or raster data encoded in tagged image file format (TIFF).

### *Uncompressed Raster Data*

Uncompressed raster data consists of a simple, unencoded bit image consisting of binary data in which 1 bit represent black dots and 0 bit represent white dots. With this format, each dot line is divided into 8-dot segments. The settings of dots in each segment are controlled by the bit values of each byte of raster data. Bit 7 (the highest-order bit in the first byte of data received) corresponds to the first dot in the dot line, bit 0 corresponds to the eighth dot, and so forth.

### *Run-length Encoded Raster Data*

With run-length encoding, raster data is encoded in pairs of bytes. The first byte of each pair indicates a repetition count for the second byte. A value of zero in the first byte indicates that the pattern represented in second byte is not repeated; that is, it occurs only once. A value of 1 in the first byte indicates that the pattern is repeated once, and so forth. The first byte can specify any repetition count from 0 to 255.

### *Raster Data in Tagged Image File Format*

The tagged image file format (TIFF) combines features of the uncompressed format and run-length encoding. A *control byte* determines whether the following byte or bytes of



raster data represents a repeating pattern or an uncompressed (unencoded) pattern. It also determines the number of pattern repetitions or bytes of uncompressed data.

The control byte is a two's complement value that can be either zero, positive, or negative. A negative value (-1 to -127) indicates that the following byte represents a repeating pattern. The number of repetitions of the pattern is determined by the absolute value of the control byte.

If the control byte is zero or positive (1 to 127), the following byte(s) of data represent an uncompressed pattern. In this case, the value of the control byte plus one indicates the number of bytes making up the pattern.

In TIFF encoding, the two's complement value -128 indicates a non-operative control byte. The byte following such a byte is handled as a new control byte.

## Commands for Printing Raster Data

PRESCRIBE provides a number of commands for printing raster data, including:

- STR (SeT dot Resolution)
- RVRD (ReceiVe Raster Data)
- ENDR (END Raster data)
- RVCD (ReceiVe Compressed raster Data)
- SRO (Set Raster Options)

The principle function of the SRO command is to specify the *presentation mode*; i.e., the orientation of the raster image. If the presentation mode is  $0$  (the default mode), raster lines print along the width of the physical page, regardless of the current page orientation. If the presentation mode is  $1$ , raster lines print in the orientation of the logical page. This is illustrated in the figure that follows.

Figure 2.36. Presentation Modes

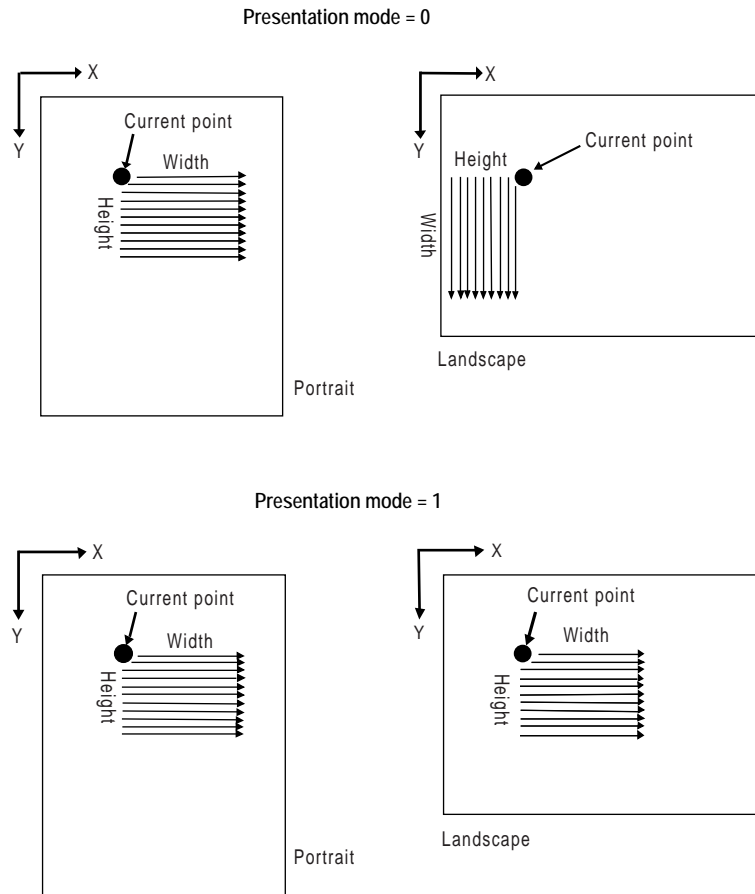

A secondary function of the SRO command specifies the width and height of the raster area. When a width and height are explicitly specified, any part of the raster image that extends outside of the area is clipped.

The STR command specifies the resolution at which raster data is printed. The default resolution is 75 dots per inch, or the equivalent of 16 physical dots for each raster-line dot. The following figure shows how a single raster-line dot correlates to physical dots at each of the available raster data resolutions.

Figure 2.37. Dot Resolutions

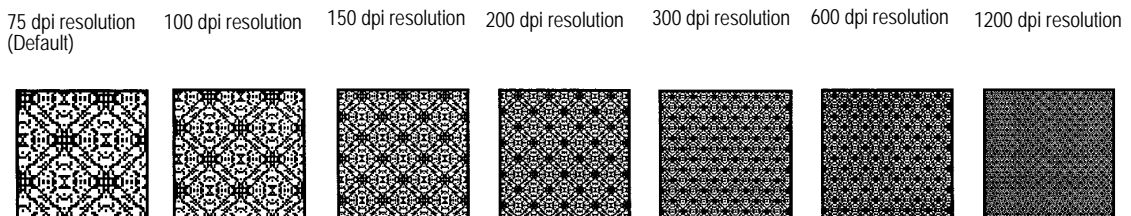

The RVRD and RVCD commands print raster data in the presentation mode specified by the SRO command and at the resolution specified by the STR command. Either command can be used. The RVRD command can only print uncompressed raster data. The RVCD command can print uncompressed raster data, run-length encoded raster data, or

tagged image file format raster data. Both commands are used with the ENDR (END Raster) command.

## Printing Raster Data

The normal sequence for printing raster data is to set the presentation mode (and, if desired, the height and width of the raster image area) with the SRO command, to set the dot resolution with the STR command, then to print the raster data with the RVRD or RVCD/ENDR command pair.

## Changing the Printing System's Imaging Model

The printing system's imaging model governs the way in which images and patterns are applied to each other. In short, it determines the transparency or opaqueness of images as images overlay one another and fill patterns are applied through images.

The image model applies to all PRESCRIBE image modes, and also to operation in the Hewlett-Packard LaserJet emulation mode.

In general, placing any image on a page involves three elements: *a pattern*, *a source image* whose black bits are replaced by the pattern, and *a destination image*, which is any earlier image onto which the source image and pattern are placed.

The fill pattern or gray scale pattern is defined by the PAT command, FPAT command, or GPAT command.

The source image is any raster graphics image, standard mode graphic, lines or shapes produced by filling or stroking a path, or text printed using any bitmap or scalable font.

The manner in which white bits in the pattern and source image are processed varies according to the *transparency mode*. There are two transparency modes: the *source transparency mode* and the *pattern transparency mode*.

When the source transparency mode is *0* (transparent), white bits in the source image have no effect on the destination image; when the source transparency mode is *1* (opaque), white bits in the source image are applied to the destination image.

Similarly, when the pattern transparency mode is *0* (transparent), white bits in the pattern do not affect the destination image; but the area of the source image replaced by the pattern dots is applied to the destination image when the pattern transparency mode is *1* (opaque).

The figure on the next page illustrates the results that are obtained by printing images using image modes; that is, using different combinations of source and pattern transparency modes.

Figure 2. 38. Image Models

Source transparency mode = 0 (transparent)  
 Pattern transparency mode = 0 (transparent)



Source transparency mode = 0 (transparent)  
 Pattern transparency mode = 1 (opaque)

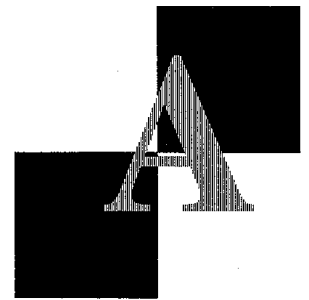

Source transparency mode = 1 (opaque)  
 Pattern transparency mode = 0 (transparent)



Source transparency mode = 1 (opaque)  
 Pattern transparency mode = 1 (opaque)

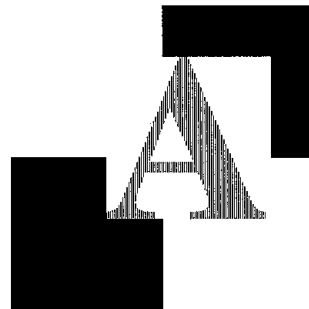

PRESCRIBE establishes the printing system's imaging model with the SIMG (Set IMaGe model) command. This command uses the following format.

`SIMG operation-mode ;`

*operation-mode* is a number from 1 to 6 that determines the image model as follows.

Operation mode	Source image	Pattern
1	Transparent	–
2	Opaque	–

3	Transparent	Transparent
4	Transparent	Opaque
5	Opaque	Transparent
6	Opaque	Opaque

With operation modes 1 and 2, the SIMG command addresses the transparency of the source image only. For operation mode 1, the white pixels of the source image do not overlay on the destination. For example, you cannot pattern a character. With operation mode 2, the SIMG command applies the white pixels of the source image onto the destination directly.

The following program example illustrates use of the SIMG command. Try changing the value specified for SIMG on line 3 and see the effect on the result (the figure on the previous page).

```

!R! RES; UNIT C;
  NEWP;
  SIMG 3; CMNT Try changing this value;
  PMZP 5, 15;
  PMRP 2, 2;
  PDRP 0, -2, 2, 0, 0, 2, -2, 0;
  PDRP -2, 0, 0, 2, 2, 0, 0, -2;
  FILL 1;
  SFNT 'TimesNewRoman', 90;
  PMRP -1.2, 1;
  GPAT .6;
  TEXT 'A';
  FILL 1;
  PAGE;
EXIT;

```

## Saving and Restoring the Graphics State

The graphics state consists of a variety of items that affect how images are rendered on the page. The graphics state contains various information related to path mode graphics and raster mode graphics.

Items included in the graphics state include the following:

- Current path and cursor position (if defined)
- Current pen diameter (line width)
- Current line join type
- Current line cap type
- Current miter limit
- Current dash pattern
- Current flatness
- Current fill pattern (16 × 16 dots)
- Current clipping rectangle
- Current raster resolution
- Current image model

While working with graphics, there often are occasions when it is useful to save the graphics state, then later to restore it. One such situation occurs when a path must be used for both stroking and filling.

For example, construction of a filled and outlined shape such as that shown below requires that we draw the path and then fill it. However, filling the path also clears it, making it unavailable for stroking.

Figure 2. 39. A Path both Stroked and Filled

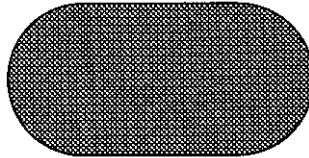

By saving the graphics state prior to filling the path, it becomes possible to restore the path after it has been filled, thereby allowing it to be stroked without reconstructing it.

The commands used for saving and restoring the graphics state are the SCG (Save Current Graphics state) command and the RPG (Return to Previous Graphics state) command.

The following program demonstrates the commands for constructing a path that is both filled and stroked.

```
!R! RES; UNIT C; NEWP;  
  PMZP 4, 2;  
  PARC 3, 3, 1, 90, 270;  
  PARC 5, 3, 1, 270, 90;  
  CLSP;  
  SCG;  
  STRK;  
  RPG;  
  GPAT .5;  
  FILL 1;  
  PAGE;  
EXIT;
```

The result appears in the figure above.

## Chapter 3

---

# Macros

After you have gone to the trouble of creating (and debugging) a PRESCRIBE command sequence, it is inefficient to use it only once, but it is a nuisance to type the same sequence repeatedly. The solution is to make the sequence into a macro. Then you can execute the entire sequence with a single CALL command. The procedure for defining a macro command sequence is simple.

Step 1: Assign a name to the sequence. Place the name at the top of the sequence (ending with a semicolon).

Step 2: Add the PRESCRIBE command MCRO in front of the name.

Step 3: Add the PRESCRIBE command ENDM at the end of the sequence.

## MCRO Command

The MCRO command assigns a name to the sequence of PRESCRIBE commands that follows, until the ENDM (END Macro) command appears. Thereafter, the entire sequence of commands can be executed by specifying the assigned name in a single CALL or AMCR (Automatic MaCRo) command. The MCRO command has the following format.

```
MCRO name [ dummy sign [ , comment ] ;
```

The *name* of a macro can be any length but only the first four characters are recognized by the PRESCRIBE command language. Any distinction between upper and lowercase letters is also ignored. For example, the following macro names are all the same:

```
ABCD
abcd
ABCDE
Abcdxyz
```

The name must start with a letter, but the other characters can include digits and special symbols such as hyphens. For example, F-1 and GRY2 are valid macro names.

The *dummy sign* (the default is the percent sign) indicates dummy parameters in the body of the macro. Dummy parameters enable you to place different variables when the macros are called. By using dummy parameters the same macro will execute differently according to the values given on the CALL command. Dummy parameters are written by writing the dummy sign followed by a number: %1 for the first dummy parameter, %2 for the second dummy parameter, and so on up to a maximum of 19 dummy parameters. The same dummy parameter can be used any number of times. Values are assigned to dummy parameters when the macro is called by the CALL command.

You do not have to specify the dummy sign in the MCRO command unless you want to use a dummy sign different from the percent sign or want to specify a comment. The printing system ignores the comment. A useful comment would be a list of the meanings of dummy parameters. In particular, a macro can contain the CALL command, permitting one macro to call another. Macro calls can be nested in this way up to a maximum depth of 20.

If the body of the macro contains TEXT, RTXT, or CTEXT commands and these have dummy parameters, the enclosing quotation marks should be included in the macro call, not in the macro definition. This enables strings containing commas, semicolons, consecutive spaces, apostrophes, and quotation marks to be printed.

If a macro with the same name has already been defined, the new definition is ignored. To redefine a macro, you must first delete the old definition with the DELM (DELEte Macro) or DAM (Delete All Macros) command, or by switching the printing system power off.

There is no particular limit on the length of a macro. The maximum number of macros that can be defined is limited only by the amount of the available memory in the printing system. Each command in a macro is limited to 255 characters in length.



Figure 3. 1. PRESCRIBE Macro Limitations

Macro limitations are summarized as follows.

Maximum number of macros downloadable to the printing system	Depends on the available printing system's memory
Maximum nesting levels	20
Maximum length of macro name	4 characters
Maximum number of parameters	19
Maximum length of CALL command	255 bytes
PRESCRIBE commands that should not be contained within a macro definition	EXIT, LDFC, MCRO, DELM, DAM, RDMP, ENDD, ICCD, WRED, EPRM

## Examples of Macros

### Example 1

The following macro example draws a circle. It first names the macro that issues the PRESCRIBE commands for drawing a circle in the middle of a page.

```
!R! MCRO CIR1;
      MZP 4, 5.5; CIR 1;
      ENDM;
EXIT;
```

When completed, this macro will draw a circle after it has been sent to the printing system.

```
!R! CALL CIR1; EXIT;
```

If you want circles of different sizes, you can make the radius into a so-called *dummy parameter*. Dummy parameters in macro definitions are denoted using percent symbols (%) as below:

```
!R! MCRO CIRCLE;
      MZP 4, 5,5; CIR %1;
      ENDM;
EXIT;
```

After this definition: CALL CIRCLE, 1; draws a one-inch circle, CALL CIRCLE, 2; draws a two-inch circle, and so on. Note the commas are required to separate the macro name from the radius parameter in these CALL statements.

## Example 2

The next file presents a more ambitious project. It makes the graph-drawing commands in the preceding section into a pair of macros to draw multiple graphs. This file may help you to better understand the macro creating process. The DAM command in the first line is a safety precaution that clears any previous macros out of memory.

```

!R! RES; UNITC; DAM;
  MCRO LOCATE;
    SLM %1;
    STM %2;
  ENDM;
  MCRO GRAPH;
    UNIT C;
    SPD 0.05; SCS 0.23;
    MAP 0, -7.3; TEXT %1;
    MAP 0, 0; BOX 6, -7;
    MAP -0.1, 0.5;
    TEXT 'Sun Mon Tue Wed Thu Fri Sat';
    MAP 0, -%2;
    DAP 1, -%3;
    DAP 2, -%4;
    DAP 3, -%5;
    DAP 4, -%6;
    DAP 5, -%7;
    DAP 6, -%8;
  ENDM;
  CALL LOCATE, 2, 9;
  CALL GRAPH, 'Temperature', 2.5, 3.5, 1.9, 3.0, 3.8, 2.8, 3.3;
  CALL LOCATE, 10, 9;
  CALL GRAPH, 'Humidity', 3.5, 1.0, 1.3, 2.6, 1.8, 6.4, 5.9;
  CALL LOCATE, 2, 20;
  CALL GRAPH, 'Paid Attendance', 5.2, 1.1, 0.9, 1.5, 1.3, 3.3, 4.4;
  CALL LOCATE, 10, 20;
  CALL GRAPH, 'Pages Completed', 0, 1.2, 4.4, 4.6, 3.2, 6.6, 0;
  PAGE;
EXIT;

```

Figure 3.2. Macro Example 2

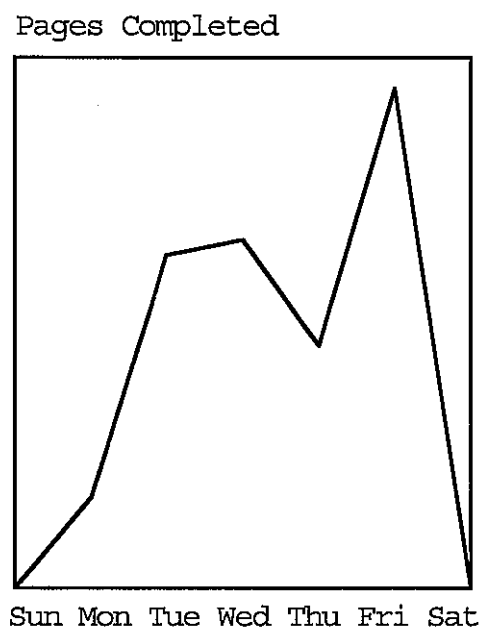
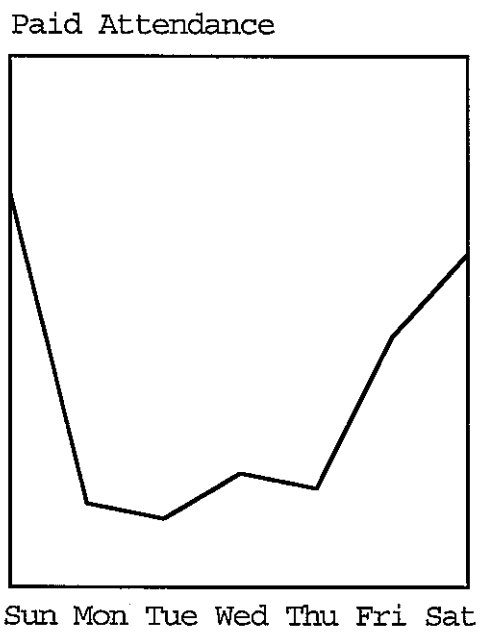
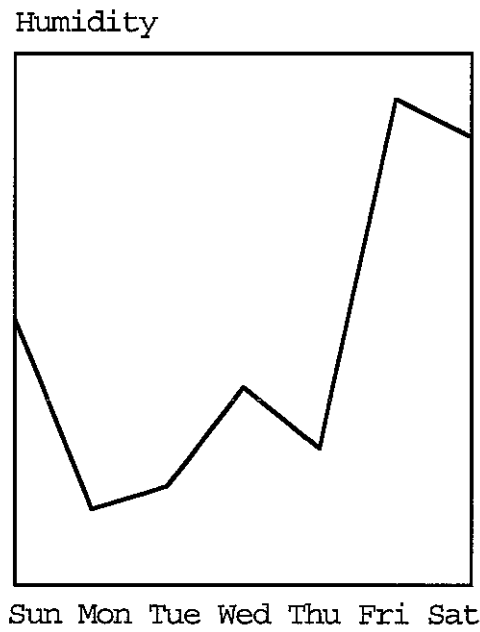
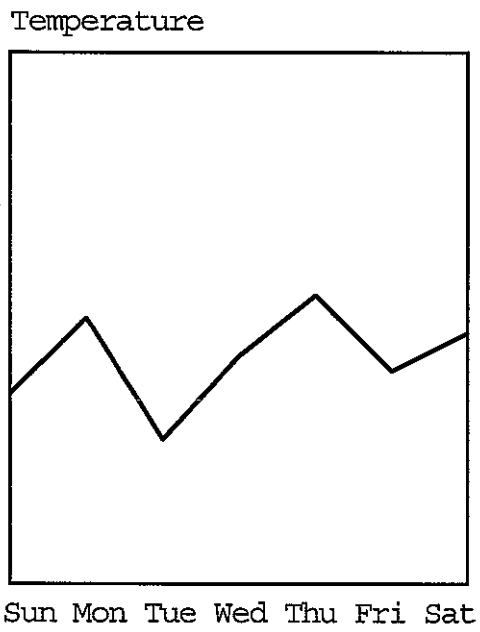

This page is left blank intentionally.

# Chapter 4

---

## Fonts

This chapter covers font-related topics, including the printing system's resident and option fonts, character sets, and usage of font-selection and symbol creation commands.

A font is a set of characters of a particular design. The design is referred to as a *typeface*. Several characteristics identify a font. These include the font type (bit map or scalable), symbol set, spacing, pitch, height, style, stroke weight, and typeface family. In selecting a font, the printing system searches the available fonts to match these characteristics based on the highest priority. For details in this regard, see *Selecting Fonts Using the FSET Command* on page 4-9 in this chapter.

## Resident Fonts

The printing system provides one bitmap font and 136 scalable (outline) fonts as the resident fonts. Also, fonts may be downloaded to the printing system's memory from a computer or a memory card. These fonts are referred to as downloadable or soft fonts. The printing system accepts as many downloadable fonts as user memory allows.

When the HP LaserJet is the printing system's default emulation, the power-up (default) font is Courier. A different default font can be selected by using the FRPO (Firmware ReProgram) command of parameters V3 (or using the printing system's operator panel key). For details, refer to *FRPO Parameters* on page 6-2.

## List of Fonts

Resident scalable fonts provide an outline of characters which can be sized according to sizing information for the font. These fonts can be scaled from 0.25 to 999.75 points in quarter point increments.

This section shows tables of the printing system's resident fonts. It is possible to print a full list of resident fonts by the FLST command (or using the printing system's operator panel key). To print a list of fonts, command:

```
!R! FLST; EXIT;
```

The following list shows all the resident fonts in the printing system. For example, *Univ-Bd* means a Universe style scalable font with bold weight.

Font Name  
Courier  
CGTimes  
CGTimes-Bd  
CGTimes-It  
CGTimes-BdIt  
CGOmega  
CGOmega-Bd  
CGOmega-It  
CGOmega-BdIt  
Coronet  
Clarendon-Cd  
Univers-Md  
Univers-Bd  
Univers-MdIt  
Univers-BdIt  
Univers-MdCd  
Univers-BdCd  
Univers-MdCdIt  
Univers-BdCdIt  
AntiqueOlive  
AntiqueOlive-Bd  
AntiqueOlive-It  
GaramondAntiqua

**Font Name**

Garamond-Hlb  
Garamond-Krsv  
Garamond-HlbKrsv  
Marigold  
Albertus-Md  
Albertus-ExBd  
Arial  
Arial-Bd  
Arial-It  
Arial-BdIt  
TimesNewRoman  
TimesNewRoman-Bd  
TimesNewRoman-It  
TimesNewRoman-BdIt  
Helvetica  
Helvetica-Bd  
Helvetica-Ob  
Helvetica-BdOb  
Helvetica-Nr  
Helvetica-NrBd  
Helvetica-NrOb  
Helvetica-NrBdOb  
Palatino  
Palatino-Bd  
Palatino-It  
Palatino-BdIt  
ITCAvantGardeGothic-Bk  
ITCAvantGardeGothic-Dm  
ITCAvantGardeGothic-  
BkOb  
ITCAvantGardeGothic-  
DmOb  
ITCBookman-Lt  
ITCBookman-Dm  
ITCBookman-LtIt  
ITCBookman-DmIt  
NewCenturySchoolbook-  
Rom  
NewCenturySchoolbook-Bd  
NewCenturySchoolbook-It  
NewCenturySchoolbook-  
BdIt  
Times-Rom  
Times-Bd  
Times-It  
Times-BdIt  
ITCZapfChancery-MdIt  
Symbol

Font Name  
SymbolPS  
Wingdings  
ITCZapfDingbats  
Courier-Bd  
Courier-It  
Courier-BdIt  
LetterGothic  
LetterGothic-Bd  
LetterGothic-It  
CourierPS  
CourierPS-Bd  
CourierPS-Ob  
CourierPS-BdOb  
LinePrinterBM8.5-Roman  
(Bitmap)

## KPDL Fonts

In KPDL (Kyocera Print-system Description Language) emulation, the printing system provides PostScript-compatible 47 scalable fonts. These fonts are also accessible by using the PRESCRIBE command.

Font Name  
Albertus-ExtraBold  
Albertus-Medium  
AntiqueOlive  
AntiqueOlive-Bold  
AntiqueOlive-Italic  
Arial  
Arial-Bold  
Arial-BoldItalic  
Arial-Italic  
AvantGarde-Book  
AvantGarde-BookOblique  
AvantGarde-Demi  
AvantGarde-DemiOblique  
Bookman-Demi  
Bookman-DemiItalic  
Bookman-Light  
Bookman-LightItalic  
CGOmega  
CGOmega-Bold  
CGOmega-BoldItalic  
CGOmega-Italic  
CGTimes  
CGTimes-Bold  
CGTimes-BoldItalic  
CGTimes-Italic



**Font Name**

Clarendon-Condensed-Bold  
Coronet  
Courier  
Courier-Bold  
Courier-BoldOblique  
Courier-Oblique  
CourierPCL  
CourierPCL-Bd  
CourierPCL-BoldItalic  
CourierPCL-Italic  
Garamond-Antiqua  
Garamond-Halbfett  
Garamond-Kursiv  
Garamond-KursivHalbfett  
Helvetica  
Helvetica-Bold  
Helvetica-BoldOblique  
Helvetica-Narrow  
Helvetica-Narrow-Bold  
Helvetica-Narrow-BoldOblique  
Helvetica-Narrow-Oblique  
Helvetica-Oblique  
LetterGothic  
LetterGothic-Bold  
LetterGothic-Italic  
Marigold  
NewCenturySchlbk-Bold  
NewCenturySchlbk-BoldItalic  
NewCenturySchlbk-Italic  
NewCenturySchlbk-Roman  
Palatino-Bold  
Palatino-BoldItalic  
Palatino-Italic  
Palatino-Roman  
Symbol  
Symbol MT  
Times-Bold  
Times-BoldItalic  
Times-Italic  
Times-Roman  
TimesNewRoman  
TimesNewRoman-Bold  
TimesNewRoman-BoldItalic  
TimesNewRoman-Italic  
Univers-Bold  
Univers-BoldItalic  
Univers-Condensed-Bold  
Univers-Condensed-BoldItalic

Font Name  
 Univers-Condensed-Medium  
 Univers-Condensed-MediumItalic  
 Univers-Medium  
 Univers-MediumItalic  
 Wingdings-Regular  
 ZapfChancery-MediumItalic  
 ZapfDingbats

## Substituting a Bitmap Font

The printing system does not contain any bitmap fonts except LinePrinterBM8.5-Roman. If the printing system receives a request for the bitmap fonts that the previous lineups of the printers supported (tabled on page 4-4), a scalable font is substituted.

For example, if Dutch801BM10-Roman, which means a Dutch 801 style bitmap font of 10-point and Roman-style and was resident to the previous models of Kyocera printers, the printing system substitutes a Times Roman style scalable font. Other options include weights for **bold** and *italic*.

The following table lists the bitmap fonts and the bitmap font numbers that the previous lineups of Kyocera printers support. The Kyocera printing system behaves exactly in the same manner when it receives these font numbers. It substitutes the scalable fonts for these fonts when required.

Font Name	Font Number		Height (Pts.)	Pitch (cpi)
	Port.	Land.		
CourierBM12-Roman	1	17	12	10
CourierBM12-Italic	37	18	12	10
CourierBM12-Bold	38	67	12	10
CourierBM12-BoldItalic	39	68	12	10
Dutch801BM10-Roman	2	19	10	Prop.
Dutch801BM10-Italic	3	20	10	Prop.
Dutch801BM10-Bold	4	21	10	Prop.
Dutch801BM10-BoldItalic	40	69	10	Prop.
Dutch801BM8-Roman	5	22	8	Prop.
Dutch801BM8-Italic	41	—	8	Prop.
Dutch801BM8-Bold	42	70	8	Prop.
Dutch801BM8-BoldItalic	43	—	8	Prop.
PrestigeEliteBM10-Roman	6	23	10	12
PrestigeEliteBM10-Italic	44	24	10	12
PrestigeEliteBM10-Bold	45	71	10	12
PrestigeEliteBM10-BoldItalic	46	72	10	12
PrestigeEliteBM7.2-Roman	7	25	7.2	16.67
PrestigeEliteBM7.2-Italic	47	—	7.2	16.67
PrestigeEliteBM7.2-Bold	48	73	7.2	16.67
PrestigeEliteBM7.2-BoldItalic	49	—	7.2	16.67
LetterGothicBM12-Roman	8	26	12	12

Font Name	Font Number		Height (Pts.)	Pitch (cpi)
	Port.	Land.		
LetterGothicBM12-Italic	50	27	12	12
LetterGothicBM12-Bold	9	28	12	12
LetterGothicBM12-BoldItalic	51	79	12	12
LinePrinterBM8.5-Roman	88	—	8.5	16.67
Swiss721BM14.4-Bold	10	29	14.4	Prop.
Swiss721BM14.4-BoldItalic	52	—	14.4	Prop.
Swiss721BM12-Bold	11	30	12	Prop.
Swiss721BM12-BoldItalic	53	—	12	Prop.
Swiss721BM10-Bold	12	31	10	Prop.
Swiss721BM10-BoldItalic	54	—	10	Prop.
Swiss721BM8-Roman	13	32	8	Prop.
Swiss721BM8-Italic	55	—	8	Prop.
Swiss721BM8-Bold	56	74	8	Prop.
Swiss721BM8-BoldItalic	57	—	8	Prop.
Swiss721BM6-Roman	14	33	6	Prop.
Swiss721BM6-Italic	58	—	6	Prop.
Swiss721BM6-Bold	59	75	6	Prop.
Swiss721BM6-BoldItalic	60	—	6	Prop.
LinePrinterBM9-Roman	15	34	9	16.67
LinePrinterBM9-Italic	61	35	9	16.67
LinePrinterBM9-Bold	62	76	9	16.67
LinePrinterBM9-BoldItalic	63	77	9	16.67
LinePrinterBM7-Roman	16	36	7	21.43
LinePrinterBM7-Italic	64	—	7	21.43
LinePrinterBM7-Bold	65	78	7	21.43
LinePrinterBM7-BoldItalic	66	—	7	21.43

## Font Selection

There are several ways to select the fonts: one way is to use the appropriate keys on the printing system's control panel; a second way is to place a PRESCRIBE command in the file to be printed, as in the examples in *Chapter 1*; a third way is to select a printing system driver within a software application. This third way is preferable because the fonts are integrated directly into the software. In the absence of this support, the user should read the following information on choosing and placing PRESCRIBE commands.

### Font Selection by PRESCRIBE Commands

The PRESCRIBE commands associated with font selection include:

- FSET (change current Font SETting by characteristic)
- SFNT (Select current FoNT by typeface)
- ALTF (select ALTernate Font) and SETF (SET alternate Font)
- SCF (Save Current Font) and RPF (Return to Previous Font)
- SCCS (Save Current Code Set) and RPCS (Return to Previous Code Set)

- CSET (Change current symbol SET)
- FTMD (set bitmap FonT MoDe)
- FONT (select current FONT by number)
- SFA (Set bitmap Font Attributes)

The FTMD and SFA commands are only valid with bitmap fonts (which are simulated by resident scalable fonts).

The following is a guideline to the use of these commands. Also, these commands are fully detailed in *PRESCRIBE Command Reference*.

### Selecting Fonts Using the SFNT Command

Use the SFNT command to specify a font by typeface or to assign a font number to a scalable font, making it possible to select a scalable font with the FONT command (See *Selecting Fonts with the FONT Command* on page 4-10.).

For example, to print text using the scalable Times font (TimesNewRoman) at 10 points, use the following sequence:

```
!R! SFNT 'TimesNewRoman', 10; EXIT;
```

Here, **TimesNewRoman** represents the typeface name and 10 represents font height in the unit of points. Note that the SFNT command recognizes all character heights in terms of points, regardless of the specified unit value.

The SFNT command is particularly useful when you want to assign the font number to a scalable font and alter its appearance by compressing, expanding, or obliquing it. The following example selects a scalable Dutch font, sizes it to 10 points, assigns it the font number 1001 and the Roman-8 symbol set, compresses it to 90 percent of its normal width, and obliques the font so that it tilts forward at an angle of 13.5 degrees.

```
!R! SFNT 'TimesNewRoman', 10, 1001, 277, .9, .3; EXIT;
```

In this sequence, the assignment of font number 1001 enables it to be selected using the FONT command. Once this assignment has been made, it remains effective until changed with another SFNT command or until the power is turned off.

Following the font number assignment, value 277 selects the symbol set *Roman-8*. A full list of symbol sets and values appear on the SFNT command page in *PRESCRIBE Commands Command Reference*.

The value .9 following the symbol set parameter indicates compression to 90 percent of normal width. Compression can be specified in a range from 0.3 (30 percent) to 3 (300%).



Finally, the value .3 concluding the font selection sequence specifies a forward tilt of 13.5 degrees. The angle for normal characters is 0. Negative values result in backward-tilting characters. The angle parameter accepts any value from -1 (-45°) to 1 (45°). Examples appear below.

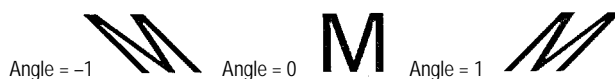

The parameters for symbol set, compression, and obliquing must be either all specified or all omitted.

## Selecting Fonts Using the FSET Command

The FSET command provides a method of selecting fonts based on font characteristics and font location in the printing system.

Font characteristics upon which selection is based appear in order of priority, from highest to lowest as follows:

Characteristic	Priority of selection
Symbol set	Highest
Spacing	2 nd
Pitch	3 rd
Point size (height)	4 th
Style	5 th
Stroke weight	6 th
Typeface family	7 th
Location	8 th
Orientation	Lowest

In selecting a font, the printing system searches the available fonts to match a characteristic based on the highest priority. If this matching produces only one font, that font is selected. If many fonts match this highest priority, then matching begins with the next highest characteristic. The printing system continues going down the list until only one font is left, then that font is selected.

A font may reside in any of three locations: printing system ROM (for resident fonts, and option fonts, if installed), memory card (for card option fonts), and printing system RAM (for downloaded fonts). A font in printing system ROM has lower priority than an identical font on a memory card, and a memory card font has a lower priority than an identical font in printing system RAM. Also, assuming all other characteristics are the same, a scalable font has lower priority than a bitmap font (simulated).

The last characteristic checked is the font orientation. If two fonts are found that differ only in orientation, the one selected is that which matches the page orientation. If only one font remains and its orientation does not match the orientation of the page, the printing system rotates the font to match the page orientation.

The example below shows an FSET command sequence that selects the 12-point, upright, normal-weight, CGTimes font. (The FSET command sequences for selecting the resident fonts appear on the font lists.)

```
FSET 1p12v0s0b4101T;
```

The FSET command sequence may be followed by a CSET (Change current symbol SET) command which selects the desired HP symbol set. In the example below, the Windows symbol set is selected.

```
CSET 9U;
```

HP symbol set values can be referenced on the CSET command page in *PRESCRIBE Commands Command Reference*.

## Selecting Fonts with the FONT Command

The FONT command uses font numbers to select fonts. A scalable font does not normally have the font number, therefore, you must take one extra step using the SFNT (Select FoNT by typeface) command. See *Selecting Fonts Using the SFNT Command* above. For example, to select the 10-point TimesNewRoman which was assigned with font number 1001, command:

```
!R!    SFNT 'TimesNewRoman', 10, 1001;
        FONT 1001;
EXIT;
```

## Bitmap Font Mode

If you use a bitmap font, a change in fonts can also affect the character spacing, line spacing, and page orientation. This depends on the *font mode* (FTMD). With bitmap fonts, setting the font mode to 15 enables the printing system to adjust all these parameters automatically. When you select font 23 (landscape PrestigeEliteBM10-Roman), for example, the printing system automatically changes the character spacing to 12 characters per inch, the line spacing to about 7.25 lines per inch, and the page orientation to landscape.

Remember that the font mode is only valid for bitmap fonts. Scalable fonts always adjust to the current page orientation. Also, with scalable fonts, you must use a line-spacing adjustment command to set the innate line spacing for the new font.

Each emulation has a default font mode for bitmap fonts which takes effect when the emulation is enabled. Font mode 15 is the default font mode of the Line Printer emulation. The other emulations have lower default font mode values.

If you use a variety of bitmap fonts, you will probably find font mode 13 most convenient. In font mode 13 character spacing and orientation are always correct, and the line spacing remains constant when you change fonts. Font mode 13 is the default font mode of the LaserJet emulation. To select font mode 13 in the other emulations, place the following sequence at the top of your program or file:

```
!R! RES; FTMD 13; EXIT;
```

(Place FTMD after RES, because RES resets the font mode.)

One reason for selecting font mode 13 over font mode 15 is that a self adjusting line spacing feature can create disastrous affects with software applications designed to handle line spacing without the assistance of PRESCRIBE.

For lower font mode, such as the default font modes in emulation modes 1 through 5, spacing and orientation adjustments may be necessary when you change fonts. Use the following commands:

SCS (Set Character Spacing) or SCPI (Set Characters Per Inch), to adjust the character spacing, SLS (Set Line Spacing) or SLPI (Set Lines Per Inch), to adjust the line spacing, SPO (Set Page Orientation), to adjust the page orientation.

The following sequences both use the FONT 19; command to select the 10-point Dutch 801 font with landscape orientation and proportional character spacing. Neither sequence affects the line spacing.

```
!R! FONT 19; SPO L; SCS 0; EXIT;
```

or

```
!R! FTMD 13; FONT 19; EXIT;
```

For making many font changes within a document, use the ALTF (change to ALternate Font) and SETF (SET alternate Font) commands instead of FONT. To switch repeatedly between fonts 6 and 8, for example, place the following sequence at the beginning of your document:

```
!R!   SETF 1,6; CMNT PrestigeEliteBM10-Roman;
      SETF 2, 8; CMNT LetterGothicBM12-Roman;
EXIT;
```

Then use !R! ALTF1; EXIT; within the document to select font 6 and !R! ALTF2; EXIT; to select font 8. The advantages of ALTF and SETF are that:

- The numbers are easy to remember (1 and 2 instead of 6 and 8).
- All the font number assignments are collected in one place, where they can be easily checked.
- If you change your mind and decide to use LetterGothicBM12-Bold (font 9) instead of LetterGothicBM12-Roman, all you have to change is one SETF command (from SETF 2, 8; to SETF 2, 9;).

In emulation modes 1, 2, and 5, the SETF command can team up in a very effective way with embedded word-processing commands. See *Chapter 7* for details.

The SCF (Save Current Font) and RPF (Return to Previous Font) commands enable font numbers to be managed in stack fashion. These commands are particularly useful at the beginning and end of macros, and when you are using embedded commands of word-processing software. To ensure that the saved font is retrieved with the correct code set, add the SCCS (Save Current Code Set) and RPCS (Return to Previous Code Set) commands to the SCF and RPF command, respectively.

For instance, to select a font using embedded commands, you can save the current font, call a new font, enter the text and return to the previous font, as in the following sequence.

```
!R! SCF; FONT 7; EXIT; (Text of footnote...)
!R! RPF; EXIT;
```

This sequence leaves the current font, prints the footnote in font 7 (PrestigeEliteBM7.2-Roman), then returns to the previous font.

## Placement of Font Commands

It is important to note that most existing word-processing software will not recognize PRESCRIBE font selection commands. However, this software typically accommodates embedded print commands whereby the PRESCRIBE command placed in a document is recognized as a print command and not as document text. The following command sequence demonstrates the embedded commands which might appear in a document.

Example of an appropriate command placement:

```
... end of previous paragraph.
!R! ALTF 2; EXIT;
Title or Heading !R! ALTF 1; EXIT;
Start of next paragraph ...
```

The first ALTF command appears on a blank line. The second ALTF command is placed at the end of a short title or heading, so that it fits on the same line and does not affect the line count.

## Font Selection by Embedded Commands

Word-processing programs with IBM and Epson printer drivers include support for a set of specific typefaces. The Kyocera printing system internally assigns these typefaces to match similar typefaces already in the printing system. Kyocera users may reassign these fonts to create a custom font list. To make this change, refer to the SETF command in *PRESCRIBE Commands Command Reference*.

Word-processing programs that support the Diablo 630 printer use embedded *ribbon-color* commands. The printing system translates these internally into ALTF commands. By placing two SETF commands at the top of a file, you can designate any two desired fonts by ribbon-color commands.

Word-processing programs that support the LaserJet printer have font description commands. Kyocera printing systems understand these commands. You can use them to select any of the fonts in the printing system.

When you select fonts by selecting your software's own commands, your software recognizes the command and is not thrown off in its tracking of characters per line or lines per page. The IBM, Epson, and LaserJet emulations support enough embedded commands to meet nearly all font selection needs. Only in the Line Printer emulation must you rely wholly on PRESCRIBE commands for font selection.

Details on font selection by embedded command appear in *Chapter 7*.

## Creation of New Symbols and Characters

With a little work, it is possible to design completely new bitmap characters by constructing their dot maps. This technique can be used to obtain special characters and symbols not provided in any of the symbol sets. The relevant command is the LDFC (Load Font Character) command.

One LDFC command defines one character, specifying its font number, character code, dimensions, orientation, and bit map. An entire new font can be created by specifying an LDFC command for each character. The command format appears as follows.

LDFC *font, code, height, width, y-offset, x-offset,*  
*cell width, center, rotation, resolution; bit map;*

Some of the dimension parameters are specified in dots (1/300 inch). Other dimensions are specified in micro dots, a unit of measurement equal to 1/32 of 1 dot. These units are used regardless of the unit set by the UNIT command. The rotation parameter is a non-executable parameter. It does not change the orientation of the character. Instead, it tells the printing system what the character's orientation is, so that the printing system can adjust the page orientation correctly (when the font mode is 8 or higher), and can select the font in response to embedded word-processing commands for a particular rotation. The rotation parameter should be the same for all characters in the font.

The bit map can be constructed by drawing the character on square-ruled paper (shown at right) and proceeding as explained below. To demonstrate, we shall encode the bit map for a small diamond-shaped character (the figure below).



Figure 4. 1. Character dot pattern

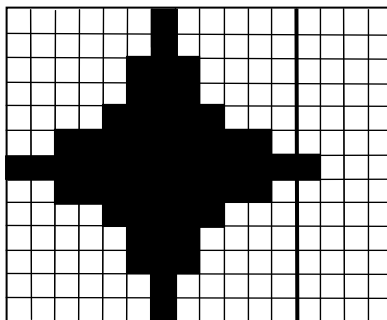

The pattern is 13 dots high and 13 dots wide. The pattern is encoded as a series of 16-bit words. If necessary, blank cells may be added on the right to make the width a multiple of 16. For this reason, the three extra columns appear on the right (see the figure above).

Each 16-bit word is encoded with three characters, representing the most significant six bits, the next six bits, and the least significant four bits, respectively, as shown in *Defining Fill Patterns* in Chapter 2.

To obtain the character codes, divide the word into sections of *six*, *six*, and *four* bits and calculate the numerical value of each section (referred to as *x*, *y*, and *z*, respectively), treating it as a binary number in which the white dots are zeros and the black dots are ones. Then add an *offset* of 64 to the values of the six-bit sections and 48 to the values of the four-bit sections. The result is the ASCII code of the character representing that section (*x*, *y*, and *z*, respectively). Refer to the example of dot map and numerical derivation in *Defining Fill Patterns* in Chapter 2. The procedure for the numerical derivation is identical to creating fill patterns for XPAT.

Six-bit sections consisting of all black dots, as in the middle row of this symbol, are a special case. They encode by using the ASCII code 127, which is the unprintable delete code. Character 47 (/) may therefore be used instead.

The resolution may be specified for 300 or 600 (dpi) only in printing system models that support the 600-dpi resolution printing. LDFC generated 300 dpi characters may print when the default resolution is 300 or 600 dpi. It is not possible for 600 dpi LDFC generated characters to print at 300 dpi.

The bit map data proceeds from left to right across the character pattern, then from top to bottom. The data can be formatted by inserting line-feeds, but not spaces. If we assign this character an x-offset of 0 and a y-offset and cell width of 500 micro dots each, and make it ASCII code 42 (\*) of font 1000, it creates the following LDFC command:

```
!R! LDFC 1000, 42, 13, 13, 500, 0, 500, 250, 0;
    @'0@'0Ap0Ap0Cx00|At0//J80|At0Cx0Ap0Ap0@'0@'0;
    UNIT C;
    BOX 4.35, 0.75, L;
    FONT 1000;
    TEXT ' * * * * * * * * * * ';
EXIT;
```

## Symbol Set

The page printing system can produce sets of alphabet, numeric, and symbol characters. These sets, with each character assigned to a particular code, are known as symbol sets.

The following figure shows all the characters included in the most common symbol set, HP Roman-8.

Figure 4. 2. Roman-8 Symbol Set

```

! " # $ % & ' ( ) * + , - . / 0 1 2 3 4 5 6 7 8 9 : ; < = > ?
@ A B C D E F G H I J K L M N O P Q R S T U V W X Y Z [ \ ] ^
_ ` a b c d e f g h i j k l m n o p q r s t u v w x y z { | } ~ ¨
À Á Â Ã Ä Å Æ Ç È É Ê Ë Ì Í Î Ï Ñ Ò Ó Ô Õ Ö × Ø Ù Ú Û Ü Ý Þ ß à á â ã
ä å æ ç è é ê ë ì í î ï ð ñ ò ó ô õ ö ÷ ø ù ú û ü ý þ ÿ • µ ¶ · ¸ ¹ º » ¼ ½ ¾

```

In addition to a large selection of bitmap and scalable fonts, the printing system supports many symbol sets (also referred to as *character sets*). The variety of Kyocera supported symbol sets can be attributed to the numerous printer emulations. Most of those symbol sets are the same regarding the letters of the alphabet, digits, and basic punctuation marks, but they differ considerably in their special symbols which lie in the upper half of the character code table, consisting of character codes 128 through 254 (hex 80 through FE).

Charts for the available symbol sets in each emulation appear in *Chapter 7*.

Only the resident fonts can be assigned with a new symbol set. All downloaded fonts contain specific symbol sets.

## International Characters

The INTL (print INTeRnational characters) command provides quick access to printing characters from a different character set, characters not found in the default symbol set (US ASCII). By simply using the INTL command with appropriate parameters for language and country code, the Kyocera user can access a wide variety of specific characters.

The following sequence selects the ISO-4 U.K. symbol set for the Swiss721BM8-Roman font in the HP LaserJet emulation:

```

!R! UNIT P; CMNT Emulation must be HPLJ;
    FONT 13;
    INTL 3, 1; CMNT ISO-4 U.K.;
EXIT;

```

The U.K. symbol set is identical to the US ASCII character set except that it has the pound currency symbol (\P) in place of the number sign (#).

It should be noted that the symbol set selected by INTL is specific to the currently emulated printer (HP LaserJet in the above example). If the current emulation is changed to Diablo 630 for the example above (by a SEM command, for example), the INTL command selects the Diablo U.K. symbol set instead of HP ISO-4 U.K. symbol set.

## Selecting HP Symbol Sets

The HP LaserJet emulation has considerably more supported symbol sets than can be accessed through the INTL command. To establish a symbol set, use one of the following commands.

- CSET (Change symbol SET)
- SFNT (Select current FoNT by typeface)

The CSET command selects a symbol set by specifying its identification code which closely resembles the command parameters of the HP printer control language. In the example below, the Windows symbol set is selected.

```
CSET 9U;
```

The CSET command may be preceded by an FSET font selection command. Remember that the symbol set has the highest priority in font selection. The following example still selects the ISO-4 U.K. symbol set for the Swiss742SWC-Roman font in the HP LaserJet emulation:

```
!R! UNIT P;
      FSET lp12v0s0b4148T; CMNT 4148 means Universe;
      CSET 1E; CMNT ISO-4 U.K.;
EXIT;
```

The SFNT command, primarily used to select and size a scalable font as stated previously, also provides the parameter that specifies a symbol set for the font. It has the following format:

```
SFNT 'typeface'[, height[, font-number[, symbol-set, compression, angle]]];
```

In the above format, the *symbol-set* parameter specifies the symbol set for the font designated by typeface. The symbol-set value must be given together with the *compression* and *angle* parameters. In the example below, the symbol-set value 37 assigns the ISO-4 U.K. symbol set to the Universe medium font.

```
!R! UNIT P;
      SFNT `Universe-Md', 12, 2000, 37, 1, 0;
      CMNT 37=ISO-4 U.K.;
EXIT;
```

The symbol set values are tabled in *LaserJet Symbol Sets* in Chapter 7.

This page is left blank intentionally.

## *Chapter 5*

---

# Barcodes

This chapter is a tutorial for encoding data into linear barcode and two-dimensional barcodes (PDF barcodes) by using `PRESCRIBE` commands. The former part of this chapter deals with how to implement the linear barcodes, the latter part explains the PDF417. They are step-by-step guide with a direct and practical approach.

# Linear Barcodes

The printing system is capable of printing a wide variety of barcodes, with human-readable text if desired. The user need only specify the type of barcode and the data to be encoded. The printing system performs the rest of the work, including bar and space generation, symbol translation, insertion of start and stop codes, checksum calculation, interleaving, padding, zero suppression, and parity reversal.



Note

The scanability of barcodes is affected by the quality of the paper and the type of scanner used. Parameters of the BARC command enable the width of the bars and spaces to be adjusted to compensate for these factors. A certain amount of testing and experimentation may be needed to find the right parameter values for a particular set of conditions.

PRESCRIBE uses the BARC (draw BARCode) command to execute barcodes. This printing system feature is described fully in this chapter.

The BARC command uses the following format.

```
BARC type, flag, 'string', short, tall[, bar1, bar2, bar3, bar4, space1, space2, space3, space4];
```

The BARC command prints specified data in barcode form. The cursor is located at the top left corner of the barcode for types 0 to 38, 40 and 41, and at the bottom left corner of the barcode for type 39, and does not move.

The *type*, *flag*, and *string* parameters are always required. The other parameters are optional. The type parameter is a number from 0 to 42 designating one of the barcode types listed in Numbers outside the range from 0 to 42 are regarded as type 15 (MSI barcode with no check digit).

The *flag* parameter specifies whether (Y or y) or not (N or n) to print a human-readable text under the barcode. The text is printed in the printing system's current font. Any desired font can be obtained by placing a font selection command before the BARC command. The flag parameter for barcodes 39 and 40 (USPS) must be N.

The *string* parameter gives the barcode data enclosed in apostrophes or quotation marks. The allowable length of the string and the characters that can be included depend on the barcode type. lists the allowed lengths and character sets.

also lists a default character that is used to fill out strings shorter than the minimum length and which may be substituted for any illegal characters in the string.

If the string is too long, it is truncated to the maximum allowed length.

Examples:

```
!R! UNIT I; BARC 11, N, '123456'; EXIT;
```



```
!R! BARC 0, Y, '12345678910'; EXIT;
```



The *short* and *tall* parameters specify the short and tall bar heights in the unit designated by the UNIT command (default: inches). The *short* and *tall* parameters must be both specified or both omitted. If they are omitted, the default values as shown in Table 5.3. must be specified.

Only barcode types 0 to 12, 35 to 38, and 39 have two bar heights. For types 13 to 34, 40, and 41, the bar height is determined by the short parameter and the tall parameter is ignored. Even when all bars are the same height, however, the command syntax requires that when a short parameter is specified, the tall parameter must be specified too.

Examples:

```
!R! UNIT I; BARC 15, N, '1234567890', .2, .2; EXIT;
```



```
!R! UNIT I; BARC 8, Y, '123456', .6, .7; EXIT;
```



When two bar heights with human-readable text are used, in some cases the tall bars may overlap the text.

The *bar1* to *bar4* and *space1* to *space4* parameters adjust the width of the bars and spaces. Fine adjustment of these parameters may be needed to obtain scannable barcodes for a particular scanner and type of paper. The dots unit (UNIT D;) is convenient. Barcode 40 (USPS FIM) ignores all these parameters and therefore has a constant height and space.

Some barcode types have only two classes of widths (*bar1*, *bar2*, *space1*, *space2*). Others have three or four classes. Regardless of the barcode type, when any width parameter is specified all eight width parameters must be specified together. In the case of two classes of widths, dummy values must be specified for *bar3*, *bar4*, *space3*, and *space4*.

The bar and space width parameters should be specified in ascending order. The maximum specifiable value is 200 dots.

$$1 \leq \text{bar1} \leq \text{bar2} \leq \text{bar3} \leq \text{bar4} \leq 200 \text{ (dots)}$$

$$1 \leq \text{space1} \leq \text{space2} \leq \text{space3} \leq \text{space4} \leq 200 \text{ (dots)}$$

If the bar and space width parameters are omitted, the printing system uses suitable default values. Table 5.3. indicates the number of width classes and the default values for each barcode type.

Barcode 19 (Code 39) has two width classes, which are set to 5 and 10 dots respectively in the example below. *Bar1* and *space1* are both 5 dots, and *bar2* and *space2* are 10 dots. *Bar3*, *space3*, *bar4*, and *space4* are all given dummy values of 10.

Examples:

```
!R! UNIT D;
BARC 19, Y, '0123ABC', 60, 60, 5, 10, 10, 10, 5, 10, 10, 10;
EXIT;
```



The above widths are doubled in the next example.

```
!R! UNIT D;
BARC 19, Y, '0123ABC', 60, 60, 10, 20, 20, 20, 10, 20, 20, 20;
EXIT;
```



Barcode 36 (EAN 8 with a five-digit supplement) has four width classes, which are set to 10, 20, 30, and 40 dots in the example below. Two bar heights are also used.

```
!R! UNIT D;
BARC 36, N, '012345678912', 180, 220, 10, 20, 30, 40, 10,
20, 30, 40;
EXIT;
```



Barcode 39 (USPS POSTNET) prints a POSTNET barcode on a mail piece. The United States Postal Service (USPS) utilizes POSTNET (POSTal Numeric Encoding Technique) to process bulk mail and business reply envelopes quickly and efficiently.

Though this barcode accepts any values within the range specified on the previous page, we recommend that all parameters except *type*, *flag*, and *string* **not** be specified as the scanability of the barcode is most effective with the default values. Also the *flag* parameter for this barcode must be N (do not print human-readable text). See the figure on 8. for POSTNET barcode location.



Barcode 41 (USPS FIM) prints a Facing Identification Mark pattern which may be printed on the envelope adjacent to the stamp. The combination of a FIM and the POST-NET (barcode 39) barcode enables faster processing by the USPS.

When generating a FIM pattern, all parameters except *type*, *flag*, and *string* are ignored. The flag parameter must be N. Characters permitted for the string parameter are 'A', 'B', 'C', and 'D' only, and each represents one of four different FIM patterns. For example, Courtesy Replay Mail and stamped reply mail require the FIM-A pattern, while Business Reply Mail and unstamped (prepaid) return mail require the FIM-C pattern. Also see the figure on 8 for FIM location.

Barcode 43 (Customer) has four bar heights. Only the shortest and tallest bar heights are specifiable, the heights for the intermediate two bars being adjusted automatically. Any values entered for bar and space widths are ignored and defaulted to 1.68 points respectively. The rules for the order of specifiable bar and space widths,  $bar1 \leq bar2 \leq bar3 \leq bar4$  and  $space1 \leq space2 \leq space3 \leq space4$ , must be adhered to, however.

*Table 5.1. Barcode Types (Sheet 1 of 2)*

No.	Type
0	UPC A
1	UPC A with two-digit supplement
2	UPC A with five-digit supplement
3	UPC D-1
4	UPC D-2
5	UPC D-3
6	UPC D-4
7	UPC D-5
8	UPC E
9	UPC E with two-digit supplement
10	UPC E with five-digit supplement
11	EAN-8
12	EAN-13
13	DUN-14 (Distribution Unit Number, EAN)
14	DUN-16 (Distribution Unit Number, EAN)
15	MSI with no check digit
16	MSI with single mod-10 check digit
17	MSI mod-10 followed by mod-10 check digit
18	MSI mod-11 followed by mod-10 check digit
19	Code 39 with no check digit (USD-3)
20	Code 39 with mod-43 check digit (USD-3)
21	Interleaved two of five (USD-1) with no check digit (See No. 41.)
22	Identicon two of five with no checksum
23	Code 128 (USD-6) manual code change
24	Code 128 (USD-6) automatic code change
25	Code 11 with only 'c' checksum (USD-8)
26	Code 11 with both 'c' and 'k' checksums (USD-8)
27	Code 93 with both 'c' and 'k' checksums (USD-7)
28	CODABAR with no check digits (USD-4)
29	Matrix two of five with no checksum
30	Datalogic two of five with no checksum
31	Industrial two of five with no checksum

Table 5.1. Barcode Types (Sheet 2 of 2)

No.	Type
32	Ames with no checksum
33	Delta distance 'a' (IBM) with no checksum
34	Delta distance 'a' (IBM) with checksum
35	EAN 8 with two-digit supplement
36	EAN 8 with five-digit supplement
37	EAN 13 with two-digit supplement
38	EAN 13 with five-digit supplement
39	POSTNET (USPS)
40	FIM (USPS)
41	Interleaved two of five (USD-1) with checksum
42	UCC/EAN 128
43	Customer
44	Wide gap CODABAR

Table 5.2. Length, Character Set, and Default (Sheet 1 of 2)

Type	Length	Character set	Default
0	11	0123456789	0
1	13		
2	16		
3	13		
4	18		
5	22		
6	25		
7	29		
8	6		
9	8		
10	11		
11	7		
12	12		
13	13		
14	15		
15	1-14		
16	1-14		
17	1-14		
18	1-14		
19	1-40	\$%+-. /0123456789ABCDEFGHIJK LMNOPQRSTUVWXYZ and space	Space
20	1-40		
21	2-26	0123456789	0
22	1-25		
23	1-40	All printable characters (ASCII codes 32 to 126)	Space
24	2-40		
25	1-45	-0123456789	Space
26	1-45		
27	1-50	All printable characters (ASCII codes 32 to 126)	Space
28	3-32	\$+-. /0123456789:abcdetn*	-

Table 5.2. Length, Character Set, and Default (Sheet 2 of 2)

Type	Length	Character set	Default
29	1-25	0123456789	0
30	1-25		
31	1-25		
32	1-25	-0123456789	0
33	1-25	0123456789KLMO	0
34	1-25		
35	9	0123456789	0
36	12		
37	14		
38	17		
39	139	0123456789	-
40	1	One of the following FIM pattern types: A – Country Reply Mail with POSTNET. B – Business Reply, Penalty and Franked Mail without POSTNET. C – Business Reply, Penalty and Franked Mail with POSTNET. D – OCR Readable Mail without POSTNET.	0
41	125	0123456789	0
42	80	All printable characters (ASCII codes 32 to 126)	
43	1-20	0123456789ABCDEFGHIJKLMNPOQRSTUVWXYZ	-
44	3-32	\$+-. /0123456789:abcdetn* and space	-

Table 5.3. Location of POSTNET and FIM

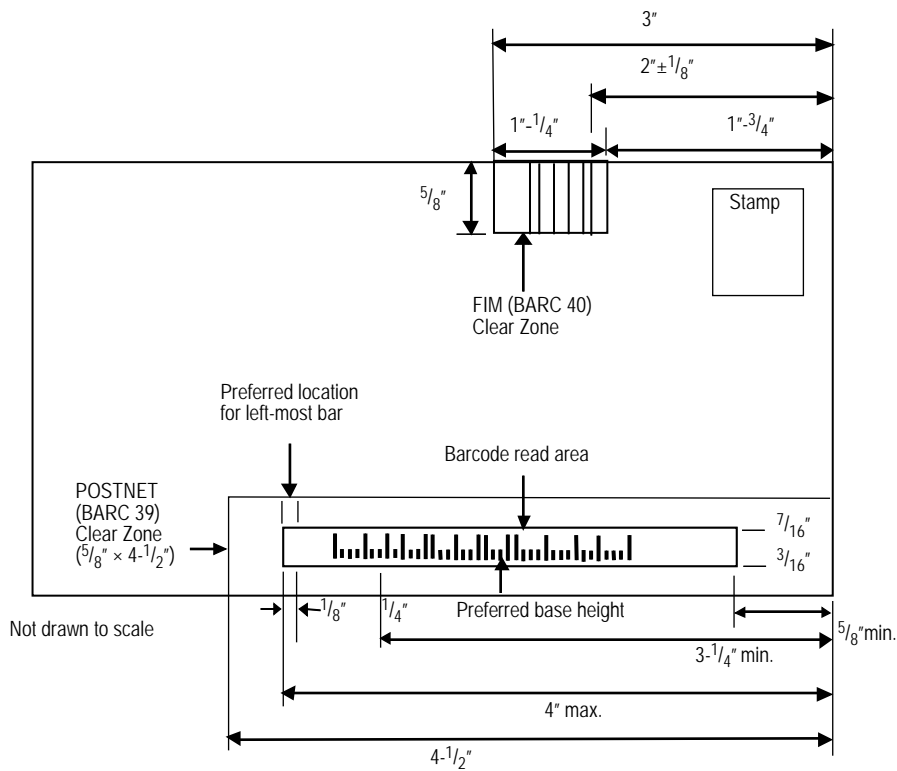

Table 5.4. Bar Height and Width Classes

Type	Tall bars	Width classes				Default (dots)			
		1	2	3	4	1	2	3	4
0	Yes	Yes	Yes	Yes	Yes	6	12	18	24
1	Yes	Yes	Yes	Yes	Yes	6	12	18	24
2	Yes	Yes	Yes	Yes	Yes	6	12	18	24
3	Yes	Yes	Yes	Yes	Yes	6	12	18	24
4	Yes	Yes	Yes	Yes	Yes	6	12	18	24
5	Yes	Yes	Yes	Yes	Yes	6	12	18	24
6	Yes	Yes	Yes	Yes	Yes	6	12	18	24
7	Yes	Yes	Yes	Yes	Yes	6	12	18	24
8	Yes	Yes	Yes	Yes	Yes	6	12	18	24
9	Yes	Yes	Yes	Yes	Yes	6	12	18	24
10	Yes	Yes	Yes	Yes	Yes	6	12	18	24
11	Yes	Yes	Yes	Yes	Yes	6	12	18	24
12	Yes	Yes	Yes	Yes	Yes	6	12	18	24
13	—	Yes	Yes	—	—	6	12	(18)	(24)
14	—	Yes	Yes	—	—	6	12	(18)	(24)
15	—	Yes	Yes	—	—	6	12	(18)	(24)
16	—	Yes	Yes	—	—	6	12	(18)	(24)
17	—	Yes	Yes	—	—	6	12	(18)	(24)
18	—	Yes	Yes	—	—	6	12	(18)	(24)
19	—	Yes	Yes	—	—	6	12	(18)	(24)
20	—	Yes	Yes	—	—	6	12	(18)	(24)
21	—	Yes	Yes	—	—	6	12	(18)	(24)

Table 5.4. Bar Height and Width Classes

Type	Tall bars	Width classes				Default (dots)			
		1	2	3	4	1	2	3	4
22	—	Yes	Yes	—	—	6	12	(18)	(24)
23	—	Yes	Yes	Yes	Yes	6	12	18	24
24	—	Yes	Yes	Yes	Yes	6	12	18	24
25	—	Yes	Yes	Yes	—	6	14	21	(21)
26	—	Yes	Yes	Yes	—	6	14	21	(21)
27	—	Yes	Yes	Yes	Yes	6	12	18	24
28	—	Yes	Yes	—	—	6	18	(18)	(18)
29	—	Yes	Yes	—	—	6	12	(18)	(24)
30	—	Yes	Yes	—	—	6	12	(18)	(24)
31	—	Yes	Yes	—	—	6	12	(18)	(24)
32	—	Yes	Yes	—	—	6	12	(18)	(24)
33	—	Yes	Yes	Yes	—	6	12	18	(24)
34	—	Yes	Yes	Yes	—	6	12	18	(24)
35	Yes	Yes	Yes	Yes	Yes	6	12	18	24
36	Yes	Yes	Yes	Yes	Yes	6	12	18	24
37	Yes	Yes	Yes	Yes	Yes	6	12	18	24
38	Yes	Yes	Yes	Yes	Yes	6	12	18	24
41	—	Yes	Yes	—	—	6	12	(18)	(24)
42	—	Yes	Yes	Yes	Yes	6	12	18	24
44	—	Yes	Yes	—	—	6	18	(18)	(18)

Table 5.5. Bar Height, Width, Pitch, and Spacing for types 39, 40, and 43

Type	Height	Width	Pitch	Spacing
39	Tall: 0.125" Short: 0.05"	0.02"	21 bars/inch	0.0475"
40	5/8"	0.031"	1/16"	(Tilt: $\pm 5^\circ$ )
43	Tall: 10.2 pt. Short: 3.4 pt.	1.68 pt.	—	1.68 pt.

## Two-dimensional Barcodes

PDF 417 is a two-dimensional stacked barcode symbology capable of encoding over a kilobyte of data per label. This is important for applications where a barcode must be more than merely an identifier, an index to reference a database.

The *portable data file* approach is well suited to applications where it is impractical to store item information in a database or where the database is not accessible when and where the item's barcode is read. Because a PDF417 symbol can store so much data, item data such as the content of a shipping manifest or equipment maintenance history can be carried on the item, without requiring access to a remote database.

Encoding data into a PDF417 barcode is a two-step process. First, data is converted into codeword values of 0-928, which represent the data. This is *high-level encoding*. Then the values are physically represented by particular bar/space patterns, which is *low-level encoding*. Decoding is the reverse process.

In addition, PDF417 is an error-correcting symbology designed for real-world applications where portions of labels can get destroyed in handling. It performs error correction by making calculations, if necessary, to reconstruct undecoded or corrupted portions of the symbol.

### PDF417 Symbol Description

At first glance, a PDF417 symbol looks like a set of stacked barcodes. When we look closer to analyze how the symbol is put together, there are several key elements. These are *rows*, *start patterns*, *stop patterns*, *codewords*, and *modules*, whose definitions are explained below.

#### *module*

The narrowest width of a bar or space in the barcode. All bars or spaces are multiples (up to six times) of this width. The nominal unit of measure.

#### *codeword*

A single group of bars and spaces (or *elements*) representing one or more numbers, letters, or other symbols (i.e., codeword values for the data to be encoded). Each PDF417 codeword contains four bars and four spaces, for a total of 17 module widths. Each codeword starts with a bar and ends with a space. See figure below.

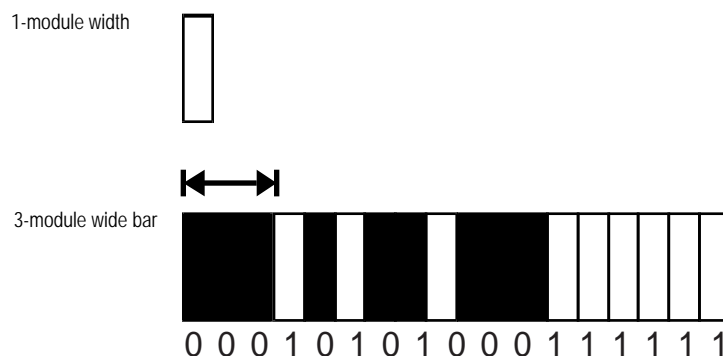

### *start pattern*

A unique pattern of light and dark elements which indicates the leftmost part of a barcode label.

### *stop pattern*

A unique pattern of light and dark elements which indicates the rightmost part of a barcode label.

### *row*

A lateral set of elements made up of a start pattern, codewords, and a stop pattern. Each PDF417 symbol must have at least 3 rows. See figure below.

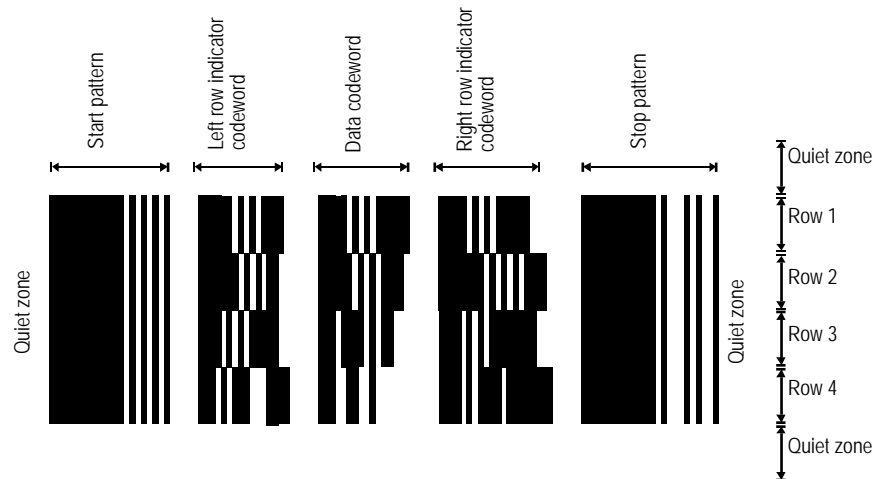

In each row, between left and right row indicators, there may be from 1 to 30 data codewords. Collectively, among all rows, these codewords form data columns.

### *Overall Symbol Structure*

Any PDF417 symbol is made up of at least 3 rows, and at most 90 rows. The minimum number of codewords in a row is 3; this includes the left row indicator codeword, 1 data codeword, and the right row indicator.

Every symbol contains 1 codeword (the first data codeword in row 0) indicating the total number of data codewords within the symbol, and at least 2 error-detection codewords. General PDF417 symbol structure is indicated in the following diagram:

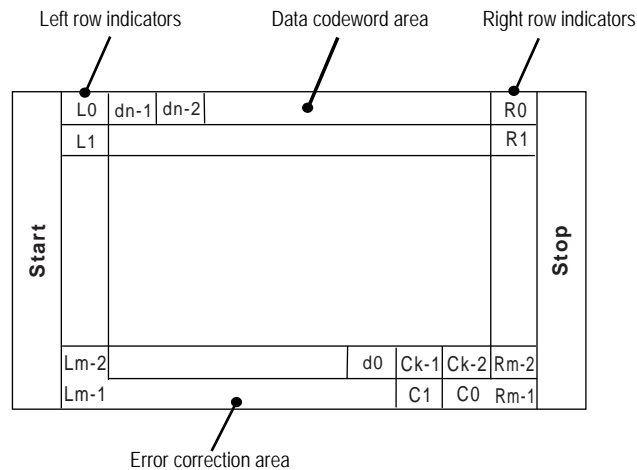

## Printing a Two-dimensional Barcode

XBAR, XBCP, XBUF, and ENDB commands support two-dimensional barcode printing. Each command does the following to put data together for printing a barcode.

XBAR	Prints a two-dimensional barcode from the given data string. Must be followed by an ENDB command.
XBCP	Specifies various options for the barcode to be printed using XBAR depending on the mode following the command (0 through 19). See <i>Macro PDF417</i> on page 14.
XBUF	Defines a buffer name for a data input for XBAR command.
ENDB	Terminates a XBAR command sequence.

### Functions of XBCP

The *mode* parameter in XBCP command format identifies the various functions as listed below. These commands are detailed in the *PRESCRIBE Commands Command Reference*.

XBCP mode	Meaning
XBCP 0	Reset
XBCP 1	Narrowest element width
XBCP 2	Error correction (by percentage)
XBCP 3	Error correction (by predetermined level)
XBCP 4	Number of rows
XBCP 5	Number of columns
XBCP 6	Aspect ratio of height and width
XBCP 7	Bar height by a ratio of element width
XBCP 8	Number of rows and columns (XBCP 4 and 5)
XBCP 9	Truncation
XBCP 10 through 19	These modes give additional control options used to support Macro PDF417 barcodes. See more details in section <i>Macro PDF417</i> .



## Positioning the Barcodes

The following commands are positioning commands the PRESCRIBE language provides. These commands are useful and sometimes essential for proper positioning of the barcodes onto a medium such as label. More detailed discussion on these (and some other) positioning commands can be found in the *PRESCRIBE Commands Command Reference*.

By default the cursor is located at the top left corner of the barcode and stays there after printing is done.

MAP	Moves the cursor to a position relative to the top and left margins.
MRP	Moves the cursor from the current to a specified relative position.
MZP	Moves the cursor to a position relative to the top and left edge limits of the page.
UNIT	Sets the unit of measurement used in the PRESCRIBE commands including the above. The initial unit is inches. The other units are related to inches as: 1 inch=2.54 centimeters=72 points=300 or 600 dots (depending on the printing system model).

## Limitations of Two-dimensional Barcode

Item	Description
Encodable character set	256 international characters and binary data
Code type	Continuous
Character self checking	Yes
Bi-directional decoding	Yes
Number of row indicator codewords required per row	2
Number of symbol checksum codewords required	2
Minimum number of rows per symbol	3
Maximum number of rows per symbol	90
Minimum number of data columns	1
Maximum number of data columns	30
Number of symbol length descriptors required	1
Smallest nominal element width	0.0075 inch or 0.191 mm
Smallest nominal element height	0.01 inch or 0.254 mm
Maximum data characters per symbol	Assuming 928 codewords – 1 symbol length descriptor – 2 symbol checksum codewords = 925 data codewords. Binary/ASCII plus mode: 1108 bytes. Extended alphanumeric compaction mode (EXC): 1850 ASCII characters. Numeric compaction mode: 2725 digits.

For Macro PDF417, which transparently distributes information among a number of PDF417 symbols, the above storage limits are increased to more than one million bytes in Binary/ASCII Plus mode and more than 2.5 million bytes in EXC mode.

## Macro PDF417

Macro PDF417 provides a powerful mechanism for creating a distributed representation of files too large to be presented by a single PDF417 barcode. Macro PDF417 barcodes differ from ordinary PDF417 barcodes in that they contain additional control options which are added by modes 10 through 19 of the XBCP command. This allows a reader to make use of this information to correctly reconstruct and verify the file, independent of the barcode scanning order.



Note

The terminology PRESCRIBE macro and macro PDF are not the same. Refer to the *PRESCRIBE Commands Command Reference* for the PRESCRIBE macro commands (MCRO, ENDM, etc.).

The following modes of XBCP are used for Macro PDF417 to represent additional control options for XBAR. Note that implementation of these parameters are optional except XBCP 17 and XBCP 18.

XBCP 10	File name
XBCP 11	Block count
XBCP 12	Time stamp
XBCP 13	Sender ID
XBCP 14	Addressee ID
XBCP 15	File size
XBCP 16	Check sum
XBCP 17	File ID
XBCP 18	Macro PDF417 execution
XBCP 19	Distributed barcodes positioning

## Creating a Macro PDF 417 Representation

A Macro PDF417 creation begins with giving *fileid* using XBCP 17 for the ensuing Macro PDF417 sequences. Each one XBAR command sequence is needed for each divided barcode which is succeeded by a XBCP 18 statement that defines a separate block index for each barcode. The block index is needed to ensure that the divided barcodes are reconstructed in the correct order as the whole file when the barcodes are read.

The basic command sequence for Macro PDF417 is as follows.

...	
XBCP 17, 'fileid' ;	Gives the same file ID to all distributed barcodes.
MZP x1, y1 ;	Position the first barcode at (x1, y1).
XBCP 18, 0 ;	Block index for the first barcode.
XBAR ; data_string ; ENDB ;	Encode and print the first divided barcode.
MZP x2, y2 ;	Position the second barcode at (x2, y2).
XBCP 18, 1 ;	Assign block index 1 to the second barcode.
XBAR ; data_string ; ENDB ;	Encode and print the second divided barcode.
MZP x3, y3 ;	Position the second barcode at (x3, y3).
XBCP 18, 2 ;	Assign block index 2 to the second barcode.
...	

The largest allowed block index is 99,998. Thus, up to 99,999 Macro PDF417 barcodes may comprise the distributed representation of a data file.

Some samples for Macro PDF417 are provided in *PRESCRIBE Commands Command Reference* on the XBCP page.



# Permanent Parameters

The printing system maintains a number of parameters in a non-volatile (flash) memory. These parameters control the initial state of the environment at power-up, including the initial emulation mode, page orientation, character set, buffer allocations in memory, interface parameters, and other options.

The parameters may be changed permanently with the FRPO (Firmware RePrOgram) command. Some FRPO parameters affect only the current interface (interface-dependent) and some affect all interfaces at once (non-interface-dependent). If the printing system is shared with other users, remember that any changes to any non-interface-dependent parameters may interfere with the print jobs of the other users. This chapter explains the FRPO command and gives examples of its use.

The current settings of the FRPO parameters are listed as option values on the printing system's service status page. Refer to the tables in this chapter to interpret the values. To print a service status page, command:

```
!R! STAT 1; EXIT;
```

Before changing any FRPO parameter, print out a service status page, so you will know the parameter values before the changes are made. To return FRPO parameters to their factory default values, send the FRPO INIT (FRPO-INITialize) command.

# FRPO Parameters

The FRPO command changes the value of one parameter in permanent memory. A separate command is required for each parameter change. The parameters, their meanings, and the specifiable values are listed below.

In these tables, the *Interface-dependent parameters* affect the environment on the current interface only. Any changes made to the parameters on one interface will not change parameters on the other interfaces. To change a similar parameter on another interface, first switch to that interface then issue the FRPO command.

The *Interface-independent parameters* affect all interfaces simultaneously. If the printing system is shared with other users, remember that changes made to non-interface-dependent parameters can affect users on other interfaces as well.



Note

Certain parameters are available only when the printing system is installed with the relevant option equipment.

## Interface-dependent Parameters

Table 6.1. Interface-dependent Parameters (Sheet 1 of 3)

Environment	Parameter	Value	Factory setting
Top margin <sup>a</sup>	A1	Integer value in inches	0
	A2	Fraction value in 1/100 inches	0
Left margin <sup>a</sup>	A3	Integer value in inches	0
	A4	Fraction value in 1/100 inches	0
Page length <sup>a</sup>	A5	Integer value in inches	13 (17) <sup>b</sup>
	A6	Fraction value in 1/100 inches	61 (30) <sup>b</sup>
Page width <sup>a</sup>	A7	Integer value in inches	13 (17) <sup>b</sup>
	A8	Fraction value in 1/100 inches	61 (30) <sup>b</sup>
Page orientation <sup>a</sup>	C1	0: Portrait, 1: Landscape	0
Default font No. <sup>a</sup>	C5	First two digits of power-up font	00
	C2	Middle two digits of power-up font	00
	C3	Last two digits of power-up font	00
Operation panel settings saving	C6	0: Not saved at power-off	1
		1: Saved at power-off	
PCL font range <sup>c</sup>	C8	0: Includes proportional bitmap fonts	0
		1: Excludes proportional bitmap fonts in range	
KC-GL options <sup>a</sup>	G0	0: Mode A; formfeed to SP0	0
		1: Mode B; formfeed to SP0	
		2: Mode A; no formfeed to SP0	
		3: Mode B; no formfeed to SP0	
		4: Fixed mode A; formfeed	
		5: Fixed mode B; formfeed	
		6: Fixed mode A; no formfeed	
		7: Fixed mode B; no formfeed	
		8: Mode A; formfeed	
		9: Mode B; formfeed	
		10: Mode A; no formfeed	
		11: Mode B; no formfeed	
		12: Fixed mode A; formfeed	
		13: Fixed mode B; formfeed	
		14: Fixed mode A; no formfeed	
15: Fixed mode B; no formfeed			
KC-GL pen width <sup>a</sup>	G1 through G8	0 to 99 dot	01/02/03/04/ 05/06/07/08
Interface release time-out	J2	0 to 99 in units of 5 seconds	6

Table 6.1. Interface-dependent Parameters (Sheet 2 of 3)

Environment	Parameter	Value	Factory setting
KC-GL enlarge mode <sup>a</sup>	J9	0: Off	0
		1: A2	
		2: A1	
		3: A0	
		4: B3	
		5: B2	
		6: B1	
		7: B0	
Duplex mode	N4	0: Simplex mode	0
		1: Long-edge binding	
		2: Short-edge binding	
Default emulation mode	P1	0: Line Printer	6
		1: IBM Proprinter X24E	
		2: Diablo 630	
		5: Epson LQ-850	
		6: HP LaserJet	
		9: KPD L	
Carriage-return action	P2	0: Ignores 0x0d	1
		1: Carriage-return	
		2: Carriage-return+linefeed	
Linefeed action	P3	0: Ignores 0x0d	1
		1: Linefeed	
		2: Linefeed+carriage-return	
Automatic emulation sensing <sup>d</sup>	P4	0: AES disabled	0
		1: AES enabled	
Alternative emulation	P5	Same as the P1 values except that 9 is ignored.	6 (HP LJ)
Automatic emulation switching trigger	P7	0: Page eject commands	10
		1: None	
		2: Page eject and Prescribe EXIT	
		3: Prescribe EXIT	
		4: Page eject commands	
		5: Formfeed (^L)	
		6: Page eject, Prescribe EXIT and formfeed	
		7: Prescribe EXIT and formfeed	
		8: Page eject commands; if AES fails, resolves to alternative emulation (P5)	
		9: None; if AES fails, resolves to alternative emulation	
		10: Page eject commands; if AES fails, resolves to KPD L	
Emulation switching after receiving !R!	P8	0: Current emulation	
		1: Default emulation (P1)	
		2: Alternative emulation (P5)	
Sorter sharing	S0	0: Stand alone	
		1: Multi users	
		2: Multiple interfaces	
Sorter mode	S1	0: Sorter	0
		1: Collator	
		2: Stacker	
		3: Mailbox	
Sorter message	S2	0: Remove sorter paper messaged	0
		1: Remove sorter paper deactivated except at power-up	
		2: Remove sorter paper deactivated	
Sorter overfilling behavior	S3	0: Interrupts printing until trays are emptied	0
		1: Bypasses printing to the face-down tray	
Job separate mode	S8	0: Whole pages	0
		1: 1st page only	
Line spacing <sup>a</sup>	U0	Lines per inch (integer value)	6
Line spacing <sup>a</sup>	U1	Lines per inch (fraction value)	0
Character spacing <sup>a</sup>	U2	Characters per inch (integer value)	10
Character spacing <sup>a</sup>	U3	Characters per inch (fraction value)	0
Country code	U6	0: US-ASCII	0
		1: France	
		2: Germany	

Table 6.1. Interface-dependent Parameters (Sheet 3 of 3)

Environment	Parameter	Value	Factory setting
		3: UK	
		4: Denmark	
		5: Sweden	
		6: Italy	
		7: Spain	
		8: Japan	
		9: US Legal	
		10: IBM PC-850 (Multilingual)	
		11: IBM PC-860 (Portuguese)	
		12: IBM PC-863 (Canadian French)	
		13: IBM PC-865 (Norwegian)	
		14: Norway	
		15: Denmark 2	
		16: Spain 2	
		17: Latin America	
		50 – 99:HP PCL symbol set coding (See page 7-37.)	
Code set at power up in daisywheel emulation	U7	0: Same as the default emulation mode (P1)	0
		1: IBM	
		2: Daisywheel	
		3: HP Roman8 (US ASCII)	
		4: Same as 3	
		5: Epson LQ-850	
		6: HP Roman-8	
		7 – 99:HP PCL symbol set coding (See page 7-37.)	
Font pitch for fixed-pitch scalable fonts	U8	Integer value in cpi: 0 – 99	10
	U9	Fraction value in 1/100 cpi: 0 – 99	0
Font height for the default scalable font <sup>a</sup>	V0	Integer value in 100 points: 0–9	0
	V1	Integer value in points: 0–99	12
	V2	Fraction value in 1/100 points: 0, 25, 50, or 75	0
Default scalable font <sup>a,e</sup>	V3	Name of typeface of up to 32 characters, enclosed with single or double quotation marks	—

<sup>a</sup> Ignored in some emulation modes.

<sup>b</sup> For models supporting A3 and ledger size paper.

<sup>c</sup> C8—PCL font range  
 The printing system offers several categories of resident fonts — PCL, KPDL and (simulated) bitmap fonts. The C8 parameter allows to prioritize font selection (evaluation) by excluding one or more font categories to simplify the printing system font environment.  
 For example, the command sequence C8, 1; lets the printing system to exclude bitmap fonts when font selection is performed in HP LaserJet emulation. (This will provide the closest matching PCL5 environment for font selection.)

<sup>d</sup> P4/P5—Automatic Emulation Switching  
 The FRPO P4 command establishes Automatic Emulation Switching (AES) between KPDL and the alternative emulation. With the P4 value of 1, the printing system will switch from KPDL emulation to non-KPDL emulation, or vice versa. Switching is triggered by the command specified by the FRPO P7 value.  
 The FRPO P5 value specifies the alternative emulation to which the printing system switches from KPDL. The factory default for P5 is the HP LaserJet.  
 The automatic emulation switching mode may not operate properly if the print job contains PRESCRIBE commands.



e V0-V3 — Default (power-up) font  
 These parameters define the default font at power up. The V3 parameter accepts a scalable font name of up to 32 characters and defines it to be the power-up font. The factory-set default font is Courier. The V0, V1, and V2 parameters specify the height of the font. The default size is 012.00 points (00, 12, 00, respectively).

The V0-V3 parameters are ignored if the specified font is not present at power-up, and the printing system selects Courier as the default font for V3.

The example below gives the PRESCRIBE sequence which changes the default font to TimesNewRoman, 14.25 points:

```
!R! FRPO V3, 'TimesNewRoman';
FRPO V0, 0;
FRPO V1, 14;
FRPO V2, 25;
EXIT;
```

The power-up font can be a simulated bitmap font by giving a font number to the C5, C2 and C3 parameters in the same manner as for V0, 1 and 2. This will set the V3 value to null.

## Interface-independent Parameters

Table 6.2. Interface-independent Parameters (Sheet 1 of 8)

Environment	Parameter	Value	Factory setting
Downloadable PCL font compression	B0	0: Off	0 (countries excluding Asia) or 1 (Asia)
		1: On	
Message language selection at power-on	B7	0: Automatically enters message language selection menu at the initial power-on. After a language is selected, B7=1 is set automatically.	1
		1: Does not automatically enter message language selection menu at power-on.	
Default pattern resolution (PAT, FPAT, GPAT)	B8	0: 300 dpi	0
		1: 600 dpi	
		3: 1200 dpi	
Minimum memory allocation for resource protection/(in duplex mode)	B9	0: 12 MB or more (16 MB or more)	0 or 1
		1: 10 MB (14 MB)	
		2: 8 MB (12 MB)	
		3: 6 MB (10 MB)	
		4: 4 MB (8 MB) 5: 2 MB (6 MB)	
Copy count	C0	Number of copies to print:1-999	1
KPD L font range	C9	0: KPD L fonts only	0
		1: KPD L and PCL fonts	
Serial line control	D0	0: XON is sent every 5 seconds during the printing system is ready or waiting. Error is ignored.	0
		1: XON is sent every 5 seconds during the printing system is ready or waiting. Error is valid.	
		10: XON is not sent. Error is ignored.	
		11: XON is not sent. Error is valid.	
A4 full page bleed <sup>a</sup>	D1	0: Off 1: On	0
Audio alarm	D2	0: Off 1: On	1
Paper size error	D3	0: Not notified	0
		1: Notified	
		2: Complies with MS certification	
Print density	D4	Number from 1 (Light) to 5 (Dark)	3
Service status page	D5	0: Not printed	1
		1: Printed	
Paper jam retry timing	D6	0: End of page	0
		1: Fuser sensor activated	
		2: Fuser sensor deactivated	
		3: Page ejection	
		4: Same as 0; non-engine-dependent	
Host buffer size	H0	0 to 99 in units of 10MB (0 to 990MB)	0

Table 6.2. Interface-independent Parameters (Sheet 2 of 8)

Environment	Parameter	Value	Factory setting
Serial interface baud rate	H1	3: 300 bps (not valid for some models)	96
		6: 600 bps (not valid for some models)	
		12: 1200 bps	
		24: 2400 bps	
		48: 4800 bps	
		96: 9600 bps	
		19: 19200 bps	
		38: 38400 bps	
Serial interface data bits	H2	57: 57600 bps	8
		11: 115200 bps	
Serial interface stop bits	H3	7 or 8	1
Serial interface parity	H4	1 or 2	0
		0: None	
		1: Odd	
		2: Even	
Serial interface protocol	H5	3: Ignore	0
		0: Combination of 1 and 3 below	
		1: DTR, positive true	
		2: DTR, negative true	
		3: XON/XOFF	
Buffer nearly-full threshold	H6	4: ETX/ACK	90
		5: XON/XOFF recognized only as protocol	
Buffer nearly-empty threshold	H7	Percentage of the received data buffer size.	70
Total host buffer size	H8	0 to 99 in units of the size defined by FRPO S5	5 (monochrome model), 10 (monochrome model with network interface), or 12 (color model)
Form feed time-out value	H9	Value in units of 5 seconds (0 to 99).	6
Memory card partition reading at power-up <sup>b</sup>	I0	Partition name on a memory card to be read automatically at power-up. Maximum of 15 printable ASCII characters (20H through 7EH), enclosed in single or double quotation marks.	—
Event log panel menu	I1	0: Off	0
		1: On	
Character width	I2	0: Normal	0
		1: HP LaserJet compatible	
Sleep timer	I5	0: Off	1
		1: On	
End-of-job interpretation for option interface OPT2	I7	Interprets EOJ given by NIC to the following:	0
		0: None	
		1: ^L (0CH)	
		2: ^D (04H)	
		3: ^L and ^D	
7: ^D and ^L			
End-of-job interpretation for print server interface	I8	Interprets EOJ issued by print server to the following:	0
		0: None	
		1: ^L (0CH)	
		2: ^D (04H)	
		3: ^L and ^D	
7: ^D and ^L			
Reduce/enlarge ratio (Models supporting A3 size only)	J0	0: 100%	0
		5: 70%	
		6: 81%	
		7: 86%	
		8: 94%	
		9: 98%	
Status send control <sup>c</sup>	M1	0: Reports status in KPDL mode only.	0
		1: Reports status in all emulations.	
		20: Treats all CTRL-T commands as data in all emulations.	

*Table 6.2. Interface-independent Parameters (Sheet 3 of 8)*

Environment	Parameter	Value	Factory setting
Default interface	M2	1: Default Serial or Option Serial 2: Parallel 3: Default Network or Option Network 4: Option Network or Option2 Network 5: USB	2 or 3
Host buffer mode <sup>d</sup>	M3	0: Automatic 1: Fixed	0
First buffer size	M4	Size of the first buffer	3 (model with network interface) or 5 (other)
Second (First) <sup>e</sup> buffer size	M5	Size of the second (first) buffer	10 (model with network interface) or 5 (other)
Third (Second) buffer size	M6	Size of the third (second) buffer	1
Forth (Third) buffer size	M7	Size of the forth (third) buffer number	5
Fifth (Forth) buffer size	M8	Size of the fifth (forth) buffer number	5
KIR mode	N0	0: Off 2: On	2
Duplex binding	N4	0: Off 1: Long edge 2: Short edge	0
Sleep timer time-out time	N5	Value in units of 5 minutes: 1 to 48 [5 to 240 min.]	6
Ecoprint level	N6	0: Off 2: On	0
Duplex	N7	0: Normal 1: Reverse output pages. 2: Allows duplex from the MP tray. 3: Allows duplex from the MP tray; reversing the output pages.	0
Printing resolution	N8	0: 300 dpi 1: 600 dpi 3: 1200 dpi	1
PCL resource protection	N9	0: Off 1: Protects permanent PCL resources and resets the environment. 2: Protects permanent and temporary PCL resources.	0
Parallel interface mode	O0	0: Normal 1: High-speed 5: Nibble (High) 70: Auto (Negotiation)	5
Message language	P0	0: English 1: French 2: German 3: Danish 4: Swedish 5: Italian 6: Spanish	0
Command recognition character	P9	ASCII code from 33 to 99	82 (R)
Default stacker	R0	1: Face-down tray 2: Face-up tray 3: Bulk tray	1
Auto cassette switching	R1	0: Cassette not switched when empty. 1: Main cassette and the first feeder cassette. 2: Main cassette and the second feeder cassette. 3: The first feeder cassette and the second feeder cassette. 4: Main cassette, the first feeder cassette, and the second feeder cassette. 5: Main cassette and the third feeder cassette. 6: The first feeder cassette and the third feeder cassette. 7: The second feeder cassette and the third feeder cassette.	0

Table 6.2. Interface-independent Parameters (Sheet 4 of 8)

Environment	Parameter	Value	Factory setting
		8: Main cassette, the first feeder cassette, and the third feeder cassette.	
		9: Main cassette, the second feeder cassette, and the third feeder cassette.	
		10: The first feeder cassette, the second feeder cassette, and the third feeder cassette.	
		11: Main cassette, the first feeder cassette, the second feeder cassette, and the third feeder cassette.	
		12: Main cassette and the fourth feeder cassette.	
		13: The first feeder cassette and the fourth feeder cassette.	
		14: The second feeder cassette and the fourth feeder cassette.	
		15: The third feeder cassette and the fourth feeder cassette.	
		16: Main cassette, the first feeder cassette, and the fourth feeder cassette.	
		17: Main cassette, the second feeder cassette, and the fourth feeder cassette.	
		18: Main cassette, the third feeder cassette, and the fourth feeder cassette.	
		19: The first feeder cassette, the second feeder cassette, and the fourth feeder cassette.	
		20: The first feeder cassette, the third feeder cassette, and the fourth feeder cassette.	
		21: The second feeder cassette, the third feeder cassette, and the fourth feeder cassette.	
		22: Main cassette, the first feeder cassette, the second feeder cassette, and the fourth feeder cassette.	
		23: Main cassette, the first feeder cassette, the third feeder cassette, and the fourth feeder cassette.	
		24: Main cassette, the second feeder cassette, the third feeder cassette, and the fourth feeder cassette.	
		25: The first feeder cassette, the second feeder cassette, the third feeder cassette, and the fourth feeder cassette.	
		26: Main cassette, the first feeder cassette, the second feeder cassette, the third feeder cassette, and the fourth feeder cassette.	
		99: Switched according to the page size command in data.	
Default paper size	R2	0: Size of the default paper cassette (See R4.)	0
		1: Monarch (3-7/8 × 7-1/2 inches)	
		2: Business (4-1/8 × 9-1/2 inches)	
		3: International DL (11 × 22 cm)	
		4: International C5 (16.2 × 22.9 cm)	
		5: Executive (7-1/4 × 10-1/2 inches)	
		6: US Letter (8-1/2 × 11 inches)	
		7: US Legal (8-1/2 × 14 inches)	
		8: A4 (21.0 × 29.7 cm)	
		9: JIS B5 (18.2 × 25.7 cm)	
		10: A3 (29.7 × 42 cm)	
		11: B4 (25.7 × 36.4 cm)	
		12: US Ledger (11 × 17 inches)	
		13: A5 (14.8 × 21 cm)	
		14: A6 (10.5 × 14.8 cm)	
		15: JIS B6 (12.8 × 18.2 cm)	
		16: Commercial #9 (3-7/8 × 8-7/8 inches)	
		17: Commercial #6 (3-5/8 × 6-1/2 inches)	
		18: ISO B5 (17.6 × 25 cm)	
		19: Custom (11.7 × 17.7 inches) <sup>f</sup>	
		30: C4 (22.9 × 32.4 cm) <sup>f</sup>	
		31: Hagaki (10 × 14.8 cm) <sup>f</sup>	
		32: Ofuku-Hagaki (14.8 × 20 cm) <sup>f</sup>	
		33: Officio II	
		36: A3 Wide	

Table 6.2. Interface-independent Parameters (Sheet 5 of 8)

Environment	Parameter	Value	Factory setting
		37: Ledger Wide	
		50: Statement	
		51: Folio	
		52: Youkei 2	
		53: Youkei 4	
Default margin settings	R3	0: HP compatible margins.	0
		1: Full PCL printable area.	
		2: Character pitch given by U2 and U3.	
		3: Full PCL printable area with character pitches given by U2 and U3.	
		10: IBM HT reference point as the left margin.	
		11: Full PCL printable area for HP emulation; HT reference point as the left margin in IBM emulation.	
		12: Uses Courier font for IBM emulation, using the pitch given by U2 and U3.	
Default cassette	R4	0: Multi-purpose tray	1
		1: Cassette 1	
		2: Cassette 2	
		3: Cassette 3	
		4: Cassette 4 or Envelope/universal feeder	
		5: Cassette 5	
		6: Cassette 6	
		99: Envelope/universal feeder (FS-9000)	
Page protect	R5	1 – 3: Automatic	1
		4 – 5: On	
MP tray paper size	R7	Same as the R2 values except: 0	0
		0: Maximum paper size of the printing system	
Daisywheel data length	R8	7: 7-bit	7
		8: 8-bit	
Default envelope feeder paper size	R9	Same as the R2 values except below	0
		0: A4 or Letter	
A4/letter equation	S4	0: Off	0
		1: On	
Host buffer size	S5	0: 10kB (x H8)	1
		1: 100kB (x H8)	
		2: 1024kB (x H8)	
RAM disk capacity	S6	0 to 1024 (MB)	50
RAM disk	S7	0: Disabled	0
		1: Enabled	
Serial interface mode	S9	0: Normal	0
		1: Barcode reader	
MP tray mode	T0	0: Cassette mode	1
		1: First mode (overrides other paper sources)	
Cassette 1 paper size <sup>g</sup>	T1	6: Letter	6 (U.S.A) or 8 (Euro and other)
		7: Legal	
		8: A4	
		9: B5	
		13: A5	
Cassette 2 paper size <sup>g</sup>	T2	Same as above.	6 (U.S.A) or 8 (Euro and other)
Wide A4	T6	0: Off	0
		1: On	
MP tray direction <sup>h</sup>	T8	0: Short edge	1
		1: Long edge	
Paper thickness	T9	0: Normal	0
		1: Thick	
		2: Thin	
		3: Extra thick	
Status page print at power-up	U5	0: Not printed automatically	0
		1: Printed automatically at power-up	
Default Courier weight	V9	0: Dark	0
		1: Normal	

Table 6.2. Interface-independent Parameters (Sheet 6 of 8)

Environment	Parameter	Value	Factory setting
Color mode	W1	0: Monochrome (grayscale) 1: Color (CMYK) 2: Quick color (CMY)	1
Color quality	W2	0: Normal 1: Quick color 2: Picture 3: Presentation	0
Color matching	W3	0: None 1: Auto 2: Vivid color 3: Display	0
Monitor simulation	W4	0: None 1: SMPTE240M 2: HDTV (sRGB) 3: SONY Trinitron 4: Apple AGB 5: NTSC 6: KC RGB 7: Custom	2 (For the FS-8000C, 0 and 2 only)
Ink simulation	W5	1: None 2: SWOP 3: Euroscale 4: TOYO 5: DIC	1
Gloss mode	W6	0: Low (normal) 1: High	0
Paper type for the MP tray	X0	1: Plain 2: Transparency 3: Preprinted 4: Label 5: Bond 6: Recycle 7: Vellum 8: Rough 9: Letterhead 10: Color 11: Prepunched 12: Envelope 13: Cardstock 21: Custom1 22: Custom2 23: Custom3 24: Custom4 25: Custom5 26: Custom6 27: Custom7 28: Custom8	1
Paper type for paper cassettes 1 to 6	X1 – X6	1: Plain 3: Preprinted 5: Bond 6: Recycled 8: Rough 9: Letterhead 10: Color 11: Prepunched 21: Custom1 22: Custom2 23: Custom3 24: Custom4 25: Custom5 26: Custom6 27: Custom7 28: Custom8	1
Paper type for Envelope Feeder/ Universal Feeder	X7	1: Plain 3: Preprinted 4: Label 5: Bond 6: Recycled 8: Rough	1

Table 6.2. Interface-independent Parameters (Sheet 7 of 8)

Environment	Parameter	Value	Factory setting
		9: Letterhead 10: Color 11: Prepunched 12: Envelope 13: Cardstock 21: Custom1 22: Custom2 23: Custom3 24: Custom4 25: Custom5 26: Custom6 27: Custom7 28: Custom8	
PCL paper source	X9	0: Performs paper selection depending on media type. 1: Performs paper selection depending on paper sources. 2: Performs paper selection which is compatible with HP-LJ8000. 3: Combination of value 1 and 2. 8: Performs paper selection in driver priority mode. 9: Combination of value 1 and 8. 10: Combination of value 2 and 8. 11: Combination of value 1, 2 and 8.	8 (model supporting driver priority mode) or 0 (other)
Automatic continue for 'Press GO'	Y0	0: Off 1: On	0
Automatic continue timer	Y1	number from 000 to 495 in increments of 5 seconds	6
Quick fuser heater	Y2	0: On 1: Off	0 or 1
Error message for device error	Y3	0: Does not display an error message and pause the job when the device error occurs. 1: Displays an error message when duplex printing is not executed because of a possible limitation. 2: Displays an error message and pause the job when running out of staples. 3: Combination of value 1 and 2. 4: Displays an error message and pause the job when the waste punch box is full. 5: Combination of value 1 and 4. 6: Combination of value 2 and 4. 7: Combination of value 1, 2 and 4. 8: Displays an error message and pause the job when the maximum number of stapling is exceeded. 9: Combination of value 1 and 8. 10: Combination of value 2 and 8. 11: Combination of value 1, 2 and 8. 12: Combination of value 4 and 8. 13: Combination of value 1, 4 and 8. 14: Combination of value 2, 4 and 8. 15: Combination of value 1, 2, 4 and 8. 16: Displays an error message when stapling, punching, offset or rotate collate is not executed because of a possible limitation except 2, 4 and 8. 17: Combination of value 1 and 16. 18: Combination of value 2 and 16. 19: Combination of value 1, 2 and 16. 20: Combination of value 4 and 16. 21: Combination of value 1, 4 and 16. 22: Combination of value 2, 4 and 16. 23: Combination of value 1, 2, 4 and 16. 24: Combination of value 8 and 16. 25: Combination of value 1, 8 and 16. 26: Combination of value 2, 8 and 16. 27: Combination of value 1, 2, 8 and 16. 28: Combination of value 4, 8 and 16. 29: Combination of value 1, 4, 8 and 16. 30: Combination of value 2, 4, 8 and 16. 31: Combination of value 1, 2, 4, 8 and 16.	0

Table 6.2. Interface-independent Parameters (Sheet 8 of 8)

Environment	Parameter	Value	Factory setting
Duplex operation for specified paper type (Prepunched, Preprinted and Letterhead)	Y4	0: Leaves the job as is when the job which the specified paper type is specified in simplex mode. 1: Adds blank pages and prints the job in duplex mode when the job which the specified paper type is specified in simplex mode.	0
Default operation for PDF direct printing	Y5	0: Enlarges or reduces the image to fit in the current paper size. Loads paper from the current paper cassette. 1: Through the image. Loads paper which is the same size as the image. 2: Enlarges or reduces the image to fit in the current paper size. Loads Letter, A4 or A3 size paper depending on the image size. 3: Through the image. Loads Letter, A4 or A3 size paper depending on the image size. 8: Through the image. Loads paper from the current paper cassette. 9: Through the image. Loads Letter, Ledger or Legal size paper depending on the image size. 10: Enlarges or reduces the image to fit in the current paper size. Loads Letter, Ledger or Legal size paper depending on the image size.	0
e-MPS error	Y6	0: Does not print the error report and display the error message. 1: Prints the error report. 2: Displays the error message. 3: Prints the error report and displays the error message.	3

<sup>a</sup> Supported only by FS-1500 series, FS-1600 series, FS-3400 series, and FS-3600 series.

<sup>b</sup> I0—Name of the partition in memory card  
The FRPO I0 specifies a memory card partition name to be automatically read at power up. Only one partition may be specified. The data read from the named partition at power up will be available to users accessing the currently-active interface.

The command uses the following format:

```
FRPO I0, 'partition-name' ;
```

Note that a comma must be placed after the I0 parameter. The partition name should not exceed 15 printable ASCII characters (20H through 7EH) and be enclosed by single or double quotation marks. Partition names are case-sensitive so the correct upper and lowercase characters must be used in the FRPO I0 string.

The FRPO M2 parameter enables the printing system to read the partition name into a port apart from the currently active one. For instance, if the active port were the parallel port but the M2 parameter specified the serial port, then the memory card data would be available to users accessing the serial interface.

<sup>c</sup> M1—Status send control

The FRPO M1 parameter enables the user to receive printing system status information through the serial interface. By sending CTRL-T (Hex 14) from the host computer to the printing system, the user can receive status information about ready or waiting states, the total page count for the printing system, the default page size, and the available memory size in bytes.

<sup>d</sup> M3—Host buffer mode

The M3 parameter determines the automatic or fixed host buffer mode.

If the M3 value is 0 (automatic), the first data arriving from the computer go into buffer #1, regardless of which interface they arrive on. While buffer #1 is in use, if data also begin to arrive on a second interface they are stored in buffer #2. The printing system will print these data after it has finished printing the job received through buffer #1. The general rule is that data go to the available buffer. If the M3 value is 1 (fixed), buffer #1 is fixed to receive only the data arriving in the parallel interface; and buffer #2 is fixed in the option interface (if installed). The first data arriving on one of the interfaces go into its fixed, dedicated buffer and the printing system begins printing these data and continues as above.

The factory setting of the total host buffer size is 60 kilobytes or 500 kilobytes depending on the model. This can be altered by the FRPO H8 command. If you alter the buffer size, you must reset the printing system to bring the change in effect.



- e M5/M6/M7/M8—Host buffer size  
The printing system utilizes each one buffer for its interfaces. This enables simultaneous receiving of data from the different host computers. The FRPO M5, M6, M7, and M8 parameters determine the ratio among the sizes allocated to these buffers. Parameters M6 and M7 are provided for option interfaces.  
For example, to allocate the buffers with size ratio of 5:1, use the following format:  

```
!R! FRPO M3, 1; FRPO M5, 5; FRPO M6, 1; EXIT;
```
- f Ignored in some emulation modes.
- g Models of low-end category only.
- h A3/ledger models only.



# Chapter 7

---

## Emulation

The printing systems emulate the operation of seven other printers:

- HP LaserJet (mode 6)
- HP 7550A (mode 8)
- IBM Proprinter X24E (mode 1)
- Epson LQ-850 (mode 5)
- Diablo 630 (mode 2)
- *Standard* line printer (mode 0)
- KPDL (mode 9) [PostScript compatible]

Word-processing and graphics software for any of the above printers also works with the printing system. All you need to do is to set the printing system to emulate the printer your software supports and select the appropriate printer driver.

In rare cases when your software does not support any of the printers above, install your software to drive the *standard* line printer and use PRESCRIBE commands to control line spacing, character spacing, etc.

Inappropriate selection of printer drivers and printer-based emulations will produce undesirable results.

When shipped from the factory, the printing system is set to emulate the HP LaserJet. For best results, look for an appropriate printer driver in your software application.

You can also find the appropriate printer driver for your model in the CD-ROM supplied with the product. Or, you are encouraged to visit our Internet home page to directly download the printer driver of the latest version.

This chapter first explains how to select an emulation. Then it gives some general information applying to all the emulation modes. Finally, it goes over each of the modes, explaining the printing system's word-processing capabilities and showing its character sets. Tables of control codes and escape sequences are also given at the end of each emulation section.

## Selecting an Emulation

When installing a printing system, you can select an emulation that best suits the requirement by the application software. In most cases, the emulation will be the factory default setting (mode 6: HP LaserJet). Refer to the following diagram to locate the next level emulation in case you need to change the emulation.

For example, in printing environments using the HP plotter model HP 7550A (KC-GL), the user should select mode 8. In PostScript printing environments, mode 9 should be selected (an option on some models) .

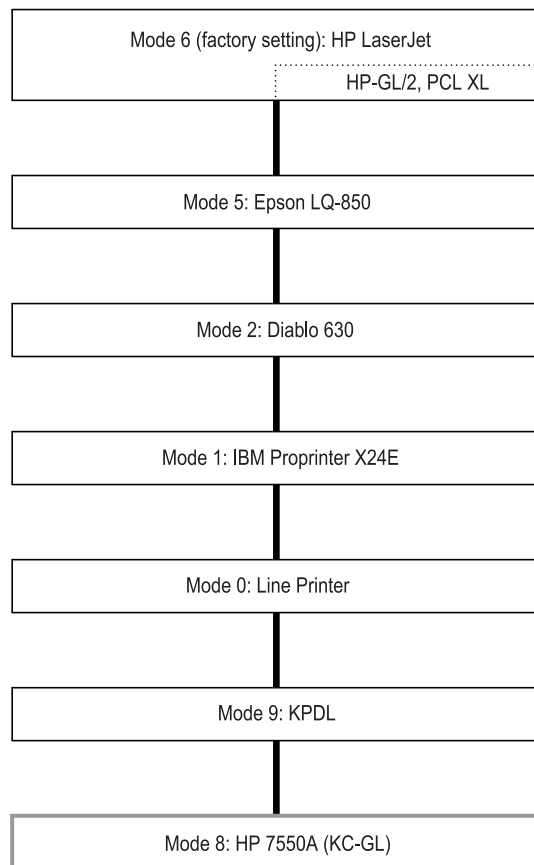

To set an emulation mode, send the printing system the FRPO commands listed in the table below.

*Table 7.1. Emulation Switching Command Sequence*

Mode	Emulation	FRPO Commands
0	Line Printer	!R! FRPO P1, 0; FRPO P3, 1; EXIT;
1	IBM Proprinter X24E	!R! FRPO P1, 1; FRPO P3, 2; EXIT;
2	Diablo 630	!R! FRPO P1, 2; FRPO P3, 1; EXIT;
5	Epson LQ-850	!R! FRPO P1, 5; FRPO P3, 2; EXIT;
6	HP LaserJet	!R! FRPO P1, 6; FRPO P3, 1; EXIT;
8	HP 7550A	!R! FRPO P1, 8; FRPO P3, 1; EXIT;
9	KPD L	!R! FRPO P1, 9; EXIT;

The emulation mode can also be changed from the printing system’s operator panel.

## Automatic emulation sensing

In printing systems that permit the selection of KPD L emulation, the automatic emulation sensing (AES) can be activated so that print jobs using other emulations will automatically print in the correct emulation. Refer to the AES related FRPO command parameters, P4 and P5, in *Interface-independent Parameters* on page 5 in *Chapter 6*.

## General Information on Emulation

The printing system's capability for supporting seven printer emulations is remarkably complete; although a few differences are noteworthy:

- The printing system cannot print on paper larger than the size of its cassette. In particular, it cannot print on continuous forms.
- The 600 dpi and 1200 dpi resolutions are supported only with HP LaserJet and KPD L emulations. Even for the models with 600 dpi and 1200 dpi support, printing occurs only with the 300 dpi resolution in Line Printer, IBM Proprinter, Diablo, and Epson emulation modes.
- The printing system's fonts do not duplicate the appearance of the fonts of the emulated printers exactly. For a fixed font, the printing system provides the same character spacing as the printer under emulation. This is not always true for proportional spacing. When proportional spacing is used, your word processing software, using an HP LaserJet driver, may be unable to properly right justify proportional text.
- The printing system supports scalable (outline) fonts. With the assistance of PRE-SCRIBE commands, the scalable fonts are available for printing in any one of the emulation modes. (See *Chapter 4* for details.)
- The graphics commands which create a path are also supported in all emulation modes. Instructions on how to create a path are described in *Chapter 2*.
- In all emulations, the printing system's margins differ slightly between emulations. The margins can be adjusted with PRESCRIBE margin commands. However, they cannot be moved outside the paper edge limits.
- PRESCRIBE commands can also be used for supplementary font control. Examples are given in each section (FONT, SFNT, etc.).

## Line Printer Emulation (Mode 0)

To set the power-up emulation for Line Printer, send the printing system the following PRESCRIBE command sequence:

```
!R! FRPO P1, 0 ; FRPO P3, 1; FRPO U6, 1; EXIT;
```

The Line Printer character set options are the same as for the IBM emulation. FRPO U6, 1 selects the full IBM US ASCII character set, which includes many international characters, graphic symbols, and mathematical symbols in addition to standard ASCII. If you leave the U6 parameter at its 0 factory setting, you will get a subset excluding some international characters and symbols. The other options are US Legal (FRPO U6, 9;) and the Danish character set (FRPO U6, 4;). See Section for details.

The line printer emulation is virtually featureless. It uses only the control codes listed below.

Table 7.2. Line Printer Control Codes

Character code (decimal)	Abbreviation	Meaning
8	BS	Backspace
10	LF	Linefeed
12	FF	Formfeed
13	CR	Carriage return

Other control codes are ignored. In particular, the escape code (ESC: character code 27) is ignored. If the printing system receives the escape sequence ESC A, for example, it ignores the escape code and prints the letter A. Therefore, this emulation requires PRESCRIBE commands for controlling the printing system.

In font mode (FTMD) 15, the printing system automatically gives the innate character spacing, line spacing, and page orientation for each bitmap font, and character spacing and page orientation for each scalable font.

If a line overruns the right margin, word wrap occurs automatically in this emulation.

## IBM Proprinter X24E Emulation (Mode 1)

To set the power-up emulation for IBM Proprinter X24E, send the printing system the following PRESCRIBE command sequence:

```
!R! FRPO P1, 1; FRPO P3, 1; EXIT;
```

The IBM symbol sets include IBM PC-8 plus international characters, mathematical symbols, Greek letters, and graphic symbols, so you can print things like:

$\alpha$ $\epsilon$ $\Sigma$ $n$ $\Omega$ $\sigma\theta \approx 4GM/r^0c^2$ <span style="display: inline-block; width: 1em; height: 1em; background-color: black; vertical-align: middle;"></span>
--

Symbol sets PC-850, PC-860, PC-863, PC-865, US ASCII, and Denmark allow all ruling characters (hex B0 to DF) and underscore characters (5F) to be printed in the correct pitch for creating continuous lines.

The symbol set may be selected with the INTL command or the operator panel keys. Permanent setting of the symbol set is made with the FRPO U6 and U7 commands but not with the Proprinter escape sequences.

The following symbol sets list shows the support for the IBM emulation.

Table 7.3. IBM Proprinter X24E Symbol Sets

Symbol set	Message display	FRPO command
US ASCII	IBM PC-8	FRPO U6, 0; FRPO U7, 1;
Denmark	IBM PC-8 (D/N)	FRPO U6, 4; FRPO U7, 1;
US Legal	US Legal	FRPO U6, 9; FRPO U7, 1;
IBM PC-850 (Multilingual)	IBM PC-850	FRPO U6, 10; FRPO U7, 1;
IBM PC-860 (Portuguese)	IBM PC-860	FRPO U6, 11; FRPO U7, 1;

Table 7.3. IBM Proprinter X24E Symbol Sets

Symbol set	Message display	FRPO command
IBM PC-863 (Canadian French)	IBM PC-863	FRPO U6, 12; FRPO U7, 1;
IBM PC-865 (Norwegian)	IBM PC-865	FRPO U6, 13; FRPO U7, 1;

By giving a particular value for the U6 and U7 parameters, it is possible to use another symbol set which the Diablo does not have. For details, see *LaserJet Symbol Sets* on page 37.

At power-up or after a reset, the printing system defaults to LetterGothic (12 points, 10 cpi). This default font emulates the IBM printer's Sans-serif 10cpi font. The default font cannot be changed in the IBM Proprinter X24E emulation. (The FRPO C5, C2, and C3 commands will be ignored in the IBM Proprinter X24E emulation.)

The printing system also emulates three other IBM-printer fonts: Courier, Prestige Elite, and Courier Proportional (See the table on next page). These fonts can be obtained by embedded commands or by using a printer driver from your word-processing software that supports the IBM Proprinter X24E. No PRESCRIBE commands are needed. An embedded command gives double-wide versions and another give double-high version of all four fonts. Samples are shown on the next page.

Figure 7.4. IBM Proprinter Emulation Print Samples

In the IBM emulation, you have five basic fonts to choose from. This is Draft Sans-serif, 10 cpi.

This is also Draft Sans-serif, but in 12 cpi.

And the same, in Condensed spacing, close to 17 cpi.

**This is Letter Quality Courier, 10 cpi.**

This is Letter Quality Courier, condensed.

This is Letter Quality Prestige Elite, 12 cpi.

This is Letter Quality Courier, Proportional.

IBM-PC word-processing capabilities include both **emphasized** and **double-strike** printing, superscripts<sup>(1)</sup> and subscripts<sub>(2)</sub>, underlines and overlines. **DOUBLE-WIDE**

and **DOUBLE-HIGH**, and even

**DOUBLE-WIDE and  
DOUBLE-HIGH!**

The IBM Proprinter X24E emulation supports embedded commands for double-wide/double-high printing, emphasized printing, double-strike printing, superscripts,

subscripts, underlining, backspace, vertical and horizontal tabulation, line spacing, and paper length.

The font mode set for the IBM Proprinter X24E emulation is 0 (the printing system adjusts nothing automatically for font attributes) unless you change it by the FTMD command. If you do not need exact character spacing, you can improve the appearance of some fonts by changing the font mode to 13.

```
!R! FTMD 13; EXIT;
```

It should be noted that for FTMD 13; the default Draft Sans-serif font will be printed in 12 cpi, and the Courier Proportional font will be printed in fixed pitch.

To use some of the page printing system's other fonts, you can select them with font selection commands, but a more convenient method is available. You can substitute other fonts for the four embedded fonts with SETF (SET alternate Font) commands. This works because the printing system obtains these fonts from the following default values of the SETF command:

*Table 7.5. IBM Proprinter Fonts*

Font name	Character spacing	ALTF No.
Draft Sans-serif	10 cpi, 12 cpi	0
Courier	10 cpi	1
Prestige Elite	12 cpi	2
Draft Sans-serif	Condensed (15 cpi)	3
Courier Prop.	Proportional	4

A substitute font can be any resident font if you use the SFNT command to assign the font number. (See the SFNT command page in *PRESCRIBE Commands Command Reference*.)

To assign a font number to resident fonts for substituting the emulated fonts in IBM Proprinter X24E emulation, all the option parameters (including *symbol-set*, *compression*, and *angle*) for the SFNT command must be specified.

Landscape orientation is another feature the printing system can offer that the IBM printer cannot. If you command !R! SPO L; EXIT; the printing system rotates the current font and prints text in landscape orientation.

The printing system supports the IBM printer's bit-image graphics in portrait orientation, so graphics software using the IBM Proprinter X24E emulation will print charts, graphs, and pictures without the need for PRESCRIBE commands. The print model and clipping features of the PRESCRIBE path mode graphics will be ignored with the IBM bit-image graphics, however.

If you attempt to print beyond the right margin, the characters will wrap around and print on the next line.

## IBM Proprinter X24E Control Codes

This section provides IBM Proprinter X24E control codes which is supported by the printing system under X24E Proprinter emulation.



Table 7.6. IBM Proprinter X24E Control Codes

Command	Function	Code (hex)	Supported
BEL	Beeper	07	–
BS	Backspace	08	Yes
HT	Horizontal Tab	09	Yes
LF	Line Feed	0A	Yes
VT	Vertical Tab	0B	Yes
FF	Form Feed	0C	Yes
CR	Carriage Return	0D	Yes
SO	Double-Wide Printing by line	0E	Yes
SI	Condensed Printing	0F	Yes
DC1	Select Printer	11	–
DC2	10 CPI Print	12	Yes
DC4	Cancel Double-Wide Printing by line	14	Yes
CAN	Cancel Data	18	–
ESC * m n1 n2 <i>data</i>	Select Graphic Mode (AGM only)	1B 2A m n1 n2 <i>data</i>	–
ESC - n	Continuous Underline	1B 2D n	Yes
ESC 0	1/8 Inch Line Spacing	1B 30	Yes
ESC 1	7/72 Inch Line Spacing	1B 31	Yes
ESC 2	Start Text Line Spacing	1B 32	Yes
ESC 3 n	Graphics Line Spacing	1B 33 n	Yes
ESC 4	Set Top of Form	1B 34	Yes
ESC 5 n	Automatic Line Feed	1B 35 n	Yes
ESC 6	Select Character Set 2	1B 36	Yes
ESC 7	Select Character Set 1	1B 37	Yes
ESC :	12 CPI Printing	1B 3A	Yes
ESC =	Character Font Image Download	1B 3D	–
ESC A n	Set Text Line Spacing	1B 41 n	Yes
ESC B n1 n2...n64 null	Set Vertical Tabs	1B 42 n1 n2...n64 0	Yes
ESC C n m	Set Form Length in Line or Inches	1B 43 nm	Yes
ESC D n1 n2...n29 null	Set Horizontal Tabs	1B 44 n1 n2...n28 0	Yes
ESC E	Emphasized Printing	1B 45	Yes
ESC F	Cancel Emphasized Printing	1B 46	Yes
ESC G	Double-Strike printing	1B 47	Yes
ESC H	Cancel Double-Strike Printing	1B 48	Yes
ESC I n	Select Print Mode	1B 49 n	Yes
ESC J n	Graphics Variable Line Spacing	1B 4A n	Yes
ESC K n1 n2 v1 v2...vn	Normal-Density Bit-Image Graphics	1B 4B n1 n2 v1 v2...vn	Yes
ESC L n1 n2 v1 v2...vn	Dual-Density Bit-Image Graphics (Half-Speed)	1B 4C n1 n2 v1 v2...vn	Yes
ESC N n	Set Automatic Perforation Skip	1B 4E n	Yes
ESC O	Cancel Automatic Perforation Skip	1B 4F	Yes
ESC P n	Proportional Space Mode	1B 50 n	Yes
ESC Q n	Deselect Printer	1B 51 n	–
ESC R	Set All Tabs to Power on Settings	1B 52	Yes
ESC S n	Subscript or Superscript Printing	1B 53 n	Yes
ESC T	Cancel Subscript or Superscript	1B 54	Yes

Table 7.6. IBM Proprinter X24E Control Codes

Command	Function	Code (hex)	Supported
ESC U n	Set Print Direction	1B 55 n	–
ESC W n	Continuous Double-Wide Printing	1B 57 n	Yes
ESC X n m	Set Horizontal Margins	1B 58 n m	Yes
ESC Y n1 n2 v1 v2...vn	Dual-Density Bit-Image Graphics (Normal Speed)	1B 59 n1 n2 v1 v2...vn	Yes
ESC Z n1 n2 v1 v2...vn	High-Density Bit-Image Graphics	1B 5A n1 n2 v1 v2...vn	Yes
ESC [ @ n1 n2 m1 m2 m3 m4	Double-High Printing	1B 5B 40 n1 n2 m1 m2 m3 m4	Yes
ESC [ K n1 n2 in id p1 p2	Set Initial Condition	1B 5B 4B n1 n2 in id p1 p2	Yes
ESC [ T n1 n2 0 0 c1 c2	Set Code Page	1B 5B 54 n1 n2 0 0 c1 c2	Yes
ESC [ \ n1 n2 t1 t2 g1 g2	Set Vertical Unit	1B 5B 7C n1 n2 t1 t2 g1 g2	Yes
ESC [ g n1 n2 m data	High-Resolution Graphics	1B 5B 67 n1 n2 m data	Yes
ESC \ n1 n2	Print Continuously From All Characters Chart	1B 7C n1 n2	Yes
ESC ^	Print Single Character from All Characters Chart	1B 5E	Yes
ESC _ n	Continuous Overline	1B 2D n	Yes
ESC d n1 n2	Relative Move Inline Forward	1B 64 n1 n2	Yes
ESC j	Stop Printing	1B 6A	–
ESC e n1 n2	Relative Mode Inline Backward	1B 65 n1 n2	Yes

IBM PC-8 (D/N) (373)

	0	1	2	3	4	5	6	7	8	9	A	B	C	D	E	F
0	▶	◀	↕	!	"	#	\$	%	&	'	(	)	*	+	,	;
1	☺	☹	↕	!	"	#	\$	%	&	'	(	)	*	+	,	;
2	☺	☹	↕	!	"	#	\$	%	&	'	(	)	*	+	,	;
3	♥	♦	♣	♠	♣	♠	♣	♠	♣	♠	♣	♠	♣	♠	♣	♠
4	♣	♠	♣	♠	♣	♠	♣	♠	♣	♠	♣	♠	♣	♠	♣	♠
5	♣	♠	♣	♠	♣	♠	♣	♠	♣	♠	♣	♠	♣	♠	♣	♠
6	♣	♠	♣	♠	♣	♠	♣	♠	♣	♠	♣	♠	♣	♠	♣	♠
7	♣	♠	♣	♠	♣	♠	♣	♠	♣	♠	♣	♠	♣	♠	♣	♠
8	♣	♠	♣	♠	♣	♠	♣	♠	♣	♠	♣	♠	♣	♠	♣	♠
9	♣	♠	♣	♠	♣	♠	♣	♠	♣	♠	♣	♠	♣	♠	♣	♠
A	♣	♠	♣	♠	♣	♠	♣	♠	♣	♠	♣	♠	♣	♠	♣	♠
B	♣	♠	♣	♠	♣	♠	♣	♠	♣	♠	♣	♠	♣	♠	♣	♠
C	♣	♠	♣	♠	♣	♠	♣	♠	♣	♠	♣	♠	♣	♠	♣	♠
D	♣	♠	♣	♠	♣	♠	♣	♠	♣	♠	♣	♠	♣	♠	♣	♠
E	♣	♠	♣	♠	♣	♠	♣	♠	♣	♠	♣	♠	♣	♠	♣	♠
F	♣	♠	♣	♠	♣	♠	♣	♠	♣	♠	♣	♠	♣	♠	♣	♠

IBM Symbol Sets

IBM PC-8 (341)

	0	1	2	3	4	5	6	7	8	9	A	B	C	D	E	F
0	▶	◀	↕	!	"	#	\$	%	&	'	(	)	*	+	,	;
1	☺	☹	↕	!	"	#	\$	%	&	'	(	)	*	+	,	;
2	☺	☹	↕	!	"	#	\$	%	&	'	(	)	*	+	,	;
3	♥	♦	♣	♠	♣	♠	♣	♠	♣	♠	♣	♠	♣	♠	♣	♠
4	♣	♠	♣	♠	♣	♠	♣	♠	♣	♠	♣	♠	♣	♠	♣	♠
5	♣	♠	♣	♠	♣	♠	♣	♠	♣	♠	♣	♠	♣	♠	♣	♠
6	♣	♠	♣	♠	♣	♠	♣	♠	♣	♠	♣	♠	♣	♠	♣	♠
7	♣	♠	♣	♠	♣	♠	♣	♠	♣	♠	♣	♠	♣	♠	♣	♠
8	♣	♠	♣	♠	♣	♠	♣	♠	♣	♠	♣	♠	♣	♠	♣	♠
9	♣	♠	♣	♠	♣	♠	♣	♠	♣	♠	♣	♠	♣	♠	♣	♠
A	♣	♠	♣	♠	♣	♠	♣	♠	♣	♠	♣	♠	♣	♠	♣	♠
B	♣	♠	♣	♠	♣	♠	♣	♠	♣	♠	♣	♠	♣	♠	♣	♠
C	♣	♠	♣	♠	♣	♠	♣	♠	♣	♠	♣	♠	♣	♠	♣	♠
D	♣	♠	♣	♠	♣	♠	♣	♠	♣	♠	♣	♠	♣	♠	♣	♠
E	♣	♠	♣	♠	♣	♠	♣	♠	♣	♠	♣	♠	♣	♠	♣	♠
F	♣	♠	♣	♠	♣	♠	♣	♠	♣	♠	♣	♠	♣	♠	♣	♠

IBM PC-860 (30)

	0	1	2	3	4	5	6	7	8	9	A	B	C	D	E	F
0	◀	▶	0	@	P	`	p	ç	é	É	á	⋮	L	⊥	α	≡
1	☺	◀	!	1	A	Q	a	ü	Ä	Ä	í	☒	⊥	⊥	β	±
2	☹	↕	"	2	B	R	b	é	É	É	ó	☒	T	⊥	Γ	≥
3	♥	!!	#	3	C	S	c	â	ô	ô	ú		⊥	⊥	π	≤
4	♦	¶	\$	4	D	T	d	ä	ö	ö	ñ	⊥	⊥	⊥	Σ	∫
5	♣	§	%	5	E	U	e	à	ò	ò	Ñ	⊥	⊥	⊥	F	σ
6	♠	—	&	6	F	V	f	á	ú	ú	á	⊥	⊥	⊥	μ	÷
7	•	↕	'	7	G	W	g	ç	ù	ù	°	⊥	⊥	⊥	τ	≈
8	◼	↑	(	8	H	X	h	é	ì	ì	¿	⊥	⊥	⊥	Φ	°
9	○	↓	)	9	I	Y	i	ê	ö	ö	Ö	⊥	⊥	⊥	θ	•
A	◼	→	*	:	J	Z	j	è	ü	ü	¬	⊥	⊥	⊥	Ω	·
B	♂	←	+	;	K	[	k	{	í	í	½	⊥	⊥	⊥	δ	√
C	♀	L	,	<	L	\	l		ô	ô	¼	⊥	⊥	⊥	∞	∞
D	♫	↔	-	=	M	J	m	}	ì	ì	ı	⊥	⊥	⊥	φ	2
E	♬	▲	.	>	N	^	n	~	ã	ã	«	⊥	⊥	⊥	ε	■
F	☼	▼	/	?	O	_	o	△	â	â	»	⊥	⊥	⊥	∩	∩

IBM PC-850 (405)

	0	1	2	3	4	5	6	7	8	9	A	B	C	D	E	F
0	▶	◀	0	@	P	`	p	ç	é	É	á	☒	L	ø	Ó	-
1	☺	◀	!	1	A	Q	a	ü	æ	æ	í	☒	⊥	Ð	β	±
2	☹	↕	"	2	B	R	b	é	Æ	Æ	ó	☒	T	Ê	Ô	=
3	♥	!!	#	3	C	S	c	â	ô	ô	ú		⊥	Ë	Ò	%
4	♦	¶	\$	4	D	T	d	ä	ö	ö	ñ	⊥	⊥	È	ö	¶
5	♣	§	%	5	E	U	e	à	ò	ò	Ñ	⊥	⊥	ı	Ö	§
6	♠	—	&	6	F	V	f	á	ú	ú	á	⊥	⊥	ı	ı	μ
7	•	↕	'	7	G	W	g	ç	ù	ù	°	⊥	⊥	ı	ı	÷
8	◼	↑	(	8	H	X	h	é	ÿ	ÿ	¿	⊥	⊥	ı	ı	,
9	○	↓	)	9	I	Y	i	ê	ÿ	ÿ	Ö	⊥	⊥	ı	ı	°
A	◼	→	*	:	J	Z	j	è	ü	ü	¬	⊥	⊥	ı	ı	·
B	♂	←	+	;	K	[	k	{	ï	ï	½	⊥	⊥	ı	ı	ı
C	♀	L	,	<	L	\	l		î	î	¼	⊥	⊥	ı	ı	ı
D	♫	↔	-	=	M	J	m	}	ï	ï	ø	⊥	⊥	ı	ı	ı
E	♬	▲	.	>	N	^	n	~	Ä	Ä	×	⊥	⊥	ı	ı	ı
F	☼	▼	/	?	O	_	o	△	Å	Å	f	⊥	⊥	ı	ı	ı

IBM PC-865 (94)

	0	1	2	3	4	5	6	7	8	9	A	B	C	D	E	F
0	▶	◀	!	@	P	~	˘	p	ç	É	á	∴	L	⊥	α	≡
1	☺	☹	!	1	Q	a	q	q	ü	æ	í	☒	⊥	⊥	β	±
2	☺	☹	"	2	R	b	r	r	é	Æ	ó	☒	T	⊥	Γ	≥
3	♥	!!	#	3	C	S	c	s	â	ô	ú		⊥	⊥	π	≤
4	♦	¶	§	4	D	T	d	t	ä	ö	ñ	⊥	⊥	⊥	Σ	∫
5	♣	§	%	5	E	U	e	u	à	ò	ñ	⊥	+	F	σ	J
6	♠	—	&	6	F	V	f	v	â	û	á	⊥	⊥	⊥	μ	÷
7	●	↑	↓	7	G	W	g	w	ç	ú	°	⊥	⊥	⊥	τ	≈
8	◻	↑	(	8	H	X	h	x	ê	ÿ	¿	⊥	⊥	⊥	Φ	°
9	○	↓	)	9	I	Y	i	y	ë	ö	¸	⊥	⊥	⊥	θ	•
A	◼	→	*	:	J	Z	j	z	è	ü	¸	⊥	⊥	⊥	Ω	·
B	♂	←	+	;	K	[	k	{	ï	ø	½	⊥	⊥	⊥	δ	√
C	♀	L	/	<	L	\	l		î	£	¼	⊥	⊥	⊥	∞	∞
D	♫	↔	-	=	M	]	m	}	ì	∅	¾	⊥	⊥	⊥	φ	2
E	♪	▲	·	>	N	^	n	~	ÿ	Ä	«	⊥	⊥	⊥	€	■
F	☼	▼	/	?	O	_	o	△	å	Å	»	⊥	⊥	⊥	∩	∩

IBM PC-863 (62)

	0	1	2	3	4	5	6	7	8	9	A	B	C	D	E	F
0	▶	◀	!	@	P	~	˘	p	ç	É	á		L	⊥	α	≡
1	☺	☹	!	1	Q	a	q	q	ü	æ	í	˘	⊥	⊥	β	±
2	☺	☹	"	2	R	b	r	r	é	Æ	ó	☒	T	⊥	Γ	≥
3	♥	!!	#	3	C	S	c	s	â	ô	ú		⊥	⊥	π	≤
4	♦	¶	§	4	D	T	d	t	ä	ö	ñ	⊥	⊥	⊥	Σ	∫
5	♣	§	%	5	E	U	e	u	à	ò	ñ	⊥	+	F	σ	J
6	♠	—	&	6	F	V	f	v	â	û	á	⊥	⊥	⊥	μ	÷
7	●	↑	↓	7	G	W	g	w	ç	ú	°	⊥	⊥	⊥	τ	≈
8	◻	↑	(	8	H	X	h	x	ê	ÿ	¿	⊥	⊥	⊥	Φ	°
9	○	↓	)	9	I	Y	i	y	ë	ö	¸	⊥	⊥	⊥	θ	•
A	◼	→	*	:	J	Z	j	z	è	ü	¸	⊥	⊥	⊥	Ω	·
B	♂	←	+	;	K	[	k	{	ï	ø	½	⊥	⊥	⊥	δ	√
C	♀	L	/	<	L	\	l		î	£	¼	⊥	⊥	⊥	∞	∞
D	♫	↔	-	=	M	]	m	}	ì	∅	¾	⊥	⊥	⊥	φ	2
E	♪	▲	·	>	N	^	n	~	ÿ	Ä	«	⊥	⊥	⊥	€	■
F	☼	▼	/	?	O	_	o	△	å	Å	»	⊥	⊥	⊥	∩	∩

## Diablo 630 Emulation (Mode 2)

To set the power-up emulation for Diablo 630, send the printing system the following PRESCRIBE command sequence:

```
!R! FRPO P1, 2; FRPO P3, 1; EXIT;
```

The Diablo uses ten symbol sets as shown below. To select one of these symbol sets, use the INTL command or the operator panel keys. Permanent setting of the symbol set is made with the FRPO U6 and U7 parameters.

The factory setting for the symbol set at power-up is IBM PC-8 for all emulation modes.

*Table 7.7. Diablo 630 Emulation Symbol Sets*

Symbol set	Message display	FRPO commands
US	DIABLO US	FRPO U6, 0; FRPO U7, 2;
France	DIABLO France	FRPO U6, 1; FRPO U7, 2;
Germany	DIABLO Germany	FRPO U6, 2; FRPO U7, 2;
UK	DIABLO U.K.	FRPO U6, 3; FRPO U7, 2;
Denmark	DIABLO Denmark	FRPO U6, 4; FRPO U7, 2;
Sweden	DIABLO Sweden	FRPO U6, 5; FRPO U7, 2;
Italy	DIABLO Italy	FRPO U6, 6; FRPO U7, 2;
Spain	DIABLO Spain	FRPO U6, 7; FRPO U7, 2;
Japan	DIABLO Japan	FRPO U6, 8; FRPO U7, 2;
US Legal	US Legal	FRPO U6, 9; FRPO U7, 2;

The U0—U3 parameters of the FRPO command will be ignored in the Diablo emulation. The line and character spacing are always 6 lines and 10 characters per inch at power-up and after a reset.

In Diablo emulation, the printing system supports the embedded commands of word-processing software essentially the same way as the Diablo 630 printer does for the following features:

- Margins
- Horizontal and vertical tabulation
- Line and character spacing, including proportional spacing
- Half line feed, reverse line feed, and reverse half line feed
- Backspace and fine backspace
- Bold (shadow), double-strike, and underlining
- Graphics mode



**Note**

If you attempt to print beyond the right margin, the characters will not be printed.

A feature the printing system has that the Diablo does not is the landscape orientation. To print in landscape orientation, send the command SPO L; and select a landscape font.

*Example:*

To print in landscape, send the following command:

```
!R! SPO L; EXIT;
```

The automatic centering, justification and Hyplot mode of the Diablo printer are not supported.

Fonts can be selected by placing font commands in the file to be printed, or using SETF (set alternate font) and ALTF (change to alternate font) commands. To substitute scalable fonts for the embedded fonts using SETF command, employ the FSET command to apply the appropriate font number for that scalable font. The default font mode (FTMD) is 0, so the printing system will not adjust character spacing, line spacing, or page orientation.

The red/black ribbon feature of the Diablo 630 printer is implemented in an interesting way. The printing system translates the black ribbon command internally into an ALTF 0 command, and the red ribbon command into an ALTF 1 command. It also uses two pairs of SETF default values:

Ribbon color	Simulated bitmap font	SETF default value
Black	CourierBM12-Roman	SETF 0, 1;
Red	Dutch 801BM10-Roman	SETF 1, 2;

Accordingly, if you use the embedded command that asks for red ribbon, you will get bitmap font 2, Dutch801BM10-Roman, which the printing system emulates using a resident scalable font. This font is proportionally spaced, so you should also specify proportional spacing with an embedded command. When you change back to black ribbon, the printing system changes to bitmap font 1, CourierBM12-Roman, also emulated using a scalable font.

With SETF commands you can select any two fonts you like which correspond to the black and red ribbons. For example, you can have black mean normal CGTimes and red mean CGTimes italicized. The appropriate setup is shown below, together with a short file and the printed result.

```
!R!

SFNT 'CGTimes', 10, 3000;
SFNT 'CGTimes-It', 10, 3001;
SETF 1, 3000; CMNT Red: 10-point CGTimes;
SETF 0, 3001; CMNT Black: 10-point CGTimes Italic;
EXIT;

^[A10,000 Maniacs:^[BOur Time in Eden^[A(Elektra)
^[AGarth Brooks:^[BThe Chase^[A(Liberty)
^[ARed Hot Chill Peppers:^[BWhat Hits!?!^[A(EMI)
```

For red-ribbon, put ESC A (^[A in binary notation) at the point you would start to print in normal CGTimes, and put ESC B (^[B in binary notation) at the point to end using the font.

*Figure 7.8. Diablo Font Printout*

```
10,000 Maniacs: Our Time in Eden (Elektra)
Garth Brooks: The Chase (Liberty)
Red Hot Chill Peppers: What Hits!?! (EMI)
```

## Diablo 630 Control Codes

Table 7.9. *Diablo 630 Control Codes (Sheet 1 of 2)*

Command	Function	Code (hex)	Supported
NUL	Buffer code	00	Yes
ETX	End of text	03	Yes
ACK	Acknowledge	06	Yes
BEL	Sound bell	07	–
BS	Backspace	08	Yes
HT	Horizontal tab	09	Yes
LF	Line feed	0A	Yes
VT	Vertical tab	0B	Yes
FF	Form feed	0C	Yes
CR	Carriage return	0D	Yes
SO	Supplementary extended character set	0E	–
SI	Primary extended character set	0F	–
DC1	XON	11	Yes
DC2	Enter printwheel table download mode	12	–
DC3	XOFF	13	Yes
DC4	Exit printwheel table download mode	14	–
NAK	Printer error condition	15	Yes
EM	Access supplementary character set	19	–
DEL	Same as NUL	7F	Yes
ESC BS	Backspace 1/120 inch	1B 08	Yes
ESC HT n	Absolute horizontal tab to column n	1B 09 n	Yes
ESC LF	Reverse line feed	1B 0A	Yes
ESC VT n	Absolute vertical tab to line n	1B 0B n	Yes
ESC FF n	Set n lines per page	1B 0C n	Yes
ESC CR P	Remote reset	1B 0D 50	Yes
ESC SO DC2	Enter printwheel table download mode	1B 0E 12	–
ESC SO M	Enter program mode	1B 0E 4D	–
ESC DC1 n	Set offset to n	1B 11 n	Yes
ESC SYN n	Select printwheel type	1B 16 n	–
ESC EM 1	Upper cassette (for sheet 1)	1B 19 31	Yes
ESC EM 2	Lower cassette (for sheet 2)	1B 19 32	Yes
ESC EM E	Manual paper feed (for envelope)	1B 19 45	Yes
ESC EM R	Eject page	1B 19 52	Yes
ESC SUB SO	Memory test	1B 1A 0E	–
ESC SUB 1	Request status byte 1	1B 1A 31	–
ESC SUB 3	Request status byte 3	1B 1A 33	–
ESC SUB I	Initialize printer	1B 1A 49	Yes
ESC SUB R	Remote error reset	1B 1A 52	–
ESC GS A	Disable NAK error response from printer	1B 1D 41	–
ESC GS B	Reenable NAK error response from printer	1B 1D 42	–
ESC RS n	Set (n-1)/48-inch line spacing	1B 1E n	Yes
ESC US n	Set (n-1)/120-inch character spacing	1B 1F n	Yes
ESC %	Increase carriage setting time	1B 25	–
ESC &	Bold and shadow printing OFF	1B 26	Yes
ESC ,	Set plot precision	1B 2C	–
ESC -	Set vertical tab at current position	1B 2D	Yes
ESC . n	Change plot character	1B 2E n	–
ESC /	Auto backward printing ON	1B 2F	–
ESC \	Auto backward printing OFF	1B 5C	–
ESC 0	Set right margin at current position	1B 30	Yes
ESC 1	Set horizontal tab at current position	1B 31	Yes
ESC 2	Clear all vertical and horizontal tabs	1B 32	Yes



Table 7.9. Diablo 630 Control Codes (Sheet 2 of 2)

Command	Function	Code (hex)	Supported
ESC 3	Graphics mode ON	1B 33	Yes
ESC 4	Graphics mode OFF	1B 34	Yes
ESC 5	Forward printing mode	1B 35	Yes
ESC 6	Backward printing mode	1B 36	Yes
ESC 7	Print suppression	1B 37	–
ESC 8	Clear horizontal tab at current position	1B 38	Yes
ESC 9	Set left margin at current position	1B 39	Yes
ESC <	Reverse printing mode ON	1B 3C	–
ESC >	Reverse printing mode OFF	1B 3E	–
ESC =	Auto-center	1B 3D	–
ESC ?	Auto carriage return ON	1B 3F	Yes
ESC !	Auto carriage return OFF	1B 21	Yes
ESC A	Alternate font 1 (for red ribbon)	1B 41	Yes
ESC B	Alternate font 0 (for black ribbon)	1B 42	Yes
ESC C	Clear top and bottom margins	1B 43	Yes
ESC D	Reverse half linefeed	1B 44	Yes
ESC E	Underline ON	1B 45	Yes
ESC G	Hyplot ON–absolute move	1B 47	–
ESC G BEL	Hyplot ON–absolute plot	1B 47 07	–
ESC L	Set bottom margin at current position	1B 4C	Yes
ESC M	Auto-justify	1B 4D	–
ESC N	Restore normal carriage settling time	1B 4E	–
ESC O	Bold printing ON	1B 4F	Yes
ESC P	Proportional spacing ON	1B 50	Yes
ESC Q	Proportional spacing OFF	1B 51	Yes
ESC R	Underline OFF	1B 52	Yes
ESC S	Reset character spacing	1B 53	Yes
ESC T	Set top margin at current position	1B 54	Yes
ESC U	Half linefeed	1B 55	Yes
ESC V	Hyplot ON–relative move	1B 56	–
ESC V BEL	Hyplot–relative plot	1B 56 07	–
ESC W	Shadow printing ON	1B 57	Yes
ESC X	Bold, shadow, and underline OFF	1B 58	Yes
ESC Y	Printwheel spoke-0 character	1B 59	–
ESC Z	Printwheel spoke-95 character	1B 5A	–



Diablo U. K. (125)

	0	1	2	3	4	5	6	7	8	9	A	B	C	D	E	F
0	0	16	32	48	64	80	96	112	128	144	160	176	192	208	224	240
1	1	17	33	49	65	81	97	113	129	145	161	177	193	209	225	241
2	2	18	34	50	66	82	98	114	130	146	162	178	194	210	226	242
3	3	19	35	51	67	83	99	115	131	147	163	179	195	211	227	243
4	4	20	36	52	68	84	100	116	132	148	164	180	196	212	228	244
5	5	21	37	53	69	85	101	117	133	149	165	181	197	213	229	245
6	6	22	38	54	70	86	102	118	134	150	166	182	198	214	230	246
7	7	23	39	55	71	87	103	119	135	151	167	183	199	215	231	247
8	8	24	40	56	72	88	104	120	136	152	168	184	200	216	232	248
9	9	25	41	57	73	89	105	121	137	153	169	185	201	217	233	249
A	10	26	42	58	74	90	106	122	138	154	170	186	202	218	234	250
B	11	27	43	59	75	91	107	123	139	155	171	187	203	219	235	251
C	12	28	44	60	76	92	108	124	140	156	172	188	204	220	236	252
D	13	29	45	61	77	93	109	125	141	157	173	189	205	221	237	253
E	14	30	46	62	78	94	110	126	142	158	174	190	206	222	238	254
F	15	31	47	63	79	95	111	127	143	159	175	191	207	223	239	255

Diablo Germany (93)

	0	1	2	3	4	5	6	7	8	9	A	B	C	D	E	F
0	0	16	32	48	64	80	96	112	128	144	160	176	192	208	224	240
1	1	17	33	49	65	81	97	113	129	145	161	177	193	209	225	241
2	2	18	34	50	66	82	98	114	130	146	162	178	194	210	226	242
3	3	19	35	51	67	83	99	115	131	147	163	179	195	211	227	243
4	4	20	36	52	68	84	100	116	132	148	164	180	196	212	228	244
5	5	21	37	53	69	85	101	117	133	149	165	181	197	213	229	245
6	6	22	38	54	70	86	102	118	134	150	166	182	198	214	230	246
7	7	23	39	55	71	87	103	119	135	151	167	183	199	215	231	247
8	8	24	40	56	72	88	104	120	136	152	168	184	200	216	232	248
9	9	25	41	57	73	89	105	121	137	153	169	185	201	217	233	249
A	10	26	42	58	74	90	106	122	138	154	170	186	202	218	234	250
B	11	27	43	59	75	91	107	123	139	155	171	187	203	219	235	251
C	12	28	44	60	76	92	108	124	140	156	172	188	204	220	236	252
D	13	29	45	61	77	93	109	125	141	157	173	189	205	221	237	253
E	14	30	46	62	78	94	110	126	142	158	174	190	206	222	238	254
F	15	31	47	63	79	95	111	127	143	159	175	191	207	223	239	255



Diablo Spain (253)

0	1	2	3	4	5	6	7	8	9	A	B	C	D	E	F	
0	0	16	32	48	64	80	96	112	128	144	160	176	192	208	224	240
1	1	17	33	49	65	81	97	113	129	145	161	177	193	209	225	241
2	2	18	34	50	66	82	98	114	130	146	162	178	194	210	226	242
3	3	19	35	51	67	83	99	115	131	147	163	179	195	211	227	243
4	4	20	36	52	68	84	100	116	132	148	164	180	196	212	228	244
5	5	21	37	53	69	85	101	117	133	149	165	181	197	213	229	245
6	6	22	38	54	70	86	102	118	134	150	166	182	198	214	230	246
7	7	23	39	55	71	87	103	119	135	151	167	183	199	215	231	247
8	8	24	40	56	72	88	104	120	136	152	168	184	200	216	232	248
9	9	25	41	57	73	89	105	121	137	153	169	185	201	217	233	249
A	10	26	42	58	74	90	106	122	138	154	170	186	202	218	234	250
B	11	27	43	59	75	91	107	123	139	155	171	187	203	219	235	251
C	12	28	44	60	76	92	108	124	140	156	172	188	204	220	236	252
D	13	29	45	61	77	93	109	125	141	157	173	189	205	221	237	253
E	14	30	46	62	78	94	110	126	142	158	174	190	206	222	238	254
F	15	31	47	63	79	95	111	127	143	159	175	191	207	223	239	255

Diablo Italy (221)

0	1	2	3	4	5	6	7	8	9	A	B	C	D	E	F	
0	0	16	32	48	64	80	96	112	128	144	160	176	192	208	224	240
1	1	17	33	49	65	81	97	113	129	145	161	177	193	209	225	241
2	2	18	34	50	66	82	98	114	130	146	162	178	194	210	226	242
3	3	19	35	51	67	83	99	115	131	147	163	179	195	211	227	243
4	4	20	36	52	68	84	100	116	132	148	164	180	196	212	228	244
5	5	21	37	53	69	85	101	117	133	149	165	181	197	213	229	245
6	6	22	38	54	70	86	102	118	134	150	166	182	198	214	230	246
7	7	23	39	55	71	87	103	119	135	151	167	183	199	215	231	247
8	8	24	40	56	72	88	104	120	136	152	168	184	200	216	232	248
9	9	25	41	57	73	89	105	121	137	153	169	185	201	217	233	249
A	10	26	42	58	74	90	106	122	138	154	170	186	202	218	234	250
B	11	27	43	59	75	91	107	123	139	155	171	187	203	219	235	251
C	12	28	44	60	76	92	108	124	140	156	172	188	204	220	236	252
D	13	29	45	61	77	93	109	125	141	157	173	189	205	221	237	253
E	14	30	46	62	78	94	110	126	142	158	174	190	206	222	238	254
F	15	31	47	63	79	95	111	127	143	159	175	191	207	223	239	255

Diablo Japan (285)

	0	1	2	3	4	5	6	7	8	9	A	B	C	D	E	F
0	0	16	32	48	64	80	96	112	128	144	160	176	192	208	224	240
1	1	17	33	49	65	81	97	113	129	145	161	177	193	209	225	241
2	2	18	34	50	66	82	98	114	130	146	162	178	194	210	226	242
3	3	19	35	51	67	83	99	115	131	147	163	179	195	211	227	243
4	4	20	36	52	68	84	100	116	132	148	164	180	196	212	228	244
5	5	21	37	53	69	85	101	117	133	149	165	181	197	213	229	245
6	6	22	38	54	70	86	102	118	134	150	166	182	198	214	230	246
7	7	23	39	55	71	87	103	119	135	151	167	183	199	215	231	247
8	8	24	40	56	72	88	104	120	136	152	168	184	200	216	232	248
9	9	25	41	57	73	89	105	121	137	153	169	185	201	217	233	249
A	10	26	42	58	74	90	106	122	138	154	170	186	202	218	234	250
B	11	27	43	59	75	91	107	123	139	155	171	187	203	219	235	251
C	12	28	44	60	76	92	108	124	140	156	172	188	204	220	236	252
D	13	29	45	61	77	93	109	125	141	157	173	189	205	221	237	253
E	14	30	46	62	78	94	110	126	142	158	174	190	206	222	238	254
F	15	31	47	63	79	95	111	127	143	159	175	191	207	223	239	255

# Epson LQ-850 Emulation (Mode 5)

To set printing system to power up in the LQ-850 emulation with the LQ German symbol set, command:

```
!R! FRPO P1, 5; FRPO P3, 2; FRPO U6, 2; EXIT;
```

The Epson LQ-850 emulation uses 13 symbol sets that include both plain and italic characters. The desired symbol set can be selected with the U6 parameter of the FRPO command or changed temporarily with the INTL command or from the operator panel keys.

The Epson LQ-850 supports the following Epson symbol sets. Tables of the basic symbols are given at the end of this section.

The factory setting for the symbol set at power-up is IBM PC-8 for all emulation modes.

*Table 7.10. Epson LQ-850 Emulation Symbol Sets*

Symbol set	Message display	FRPO commands
U.S.A.	LQ US	FRPO U6, 0; FRPO U7, 0;
France	LQ France	FRPO U6, 1; FRPO U7, 0;
Germany	LQ Germany	FRPO U6, 2; FRPO U7, 0;
U.K.	LQ U.K.	FRPO U6, 3; FRPO U7, 0;
Denmark 1	LQ Denmark	FRPO U6, 4; FRPO U7, 0;
Sweden	LQ Sweden	FRPO U6, 5; FRPO U7, 0;
Italy	LQ Italy	FRPO U6, 6; FRPO U7, 0;
Spain 1	LQ Spain	FRPO U6, 7; FRPO U7, 0;
Japan	LQ Japan	FRPO U6, 8; FRPO U7, 0;
Norway	LQ Norway	FRPO U6, 14; FRPO U7, 0;
Denmark II	LQ Denmark2	FRPO U6, 15; FRPO U7, 0;
Spain II	LQ Spain2	FRPO U6, 16; FRPO U7, 0;
Latin America	Latin America	FRPO U6, 17; FRPO U7, 0;

The printing system supports the Epson graphics character sets (code page tables) of PC 437 (Epson Extended Graphics), PC 850 (Multilingual), PC 860 (Portugal), PC 863 (Canada-French), and PC 865 (Norway). These sets are available only through the use of Epson control codes. Another Epson control code also provides the US Legal character set. The Korean character set is not supported.

When power is first switched on or after a reset, the printing system always defaults in the Courier font (10 cpi). This default font emulates LQ-850's Draft, 10 cpi and cannot be changed for the LQ-850 emulation.

The printing system also emulates the other four LQ-850 fonts (five in all). These fonts can be selected by embedded commands in the word processing software or using an Epson LQ-850 printer driver. Double-wide and double-high effects are available for all five fonts.

Figure 7.11. Epson LQ-850 Font Printout

This is Draft/Epson Courier font, 10 cpi. Various  
and condensed pitches are available.

This is Epson Roman, 10 cpi.

This is Epson Sans Serif, 10 cpi.

This is Epson Prestige, 10 cpi.

LQ-850 word processing capabilities include  
*italicization* at the press of a key, plus  
**emphasized print** and **double-strike print**,  
**superscripts** <sup>(1)</sup> and **subscripts** <sub>(2)</sub>, underlining  
and overlining, ~~strike-through~~,  
**DOUBLE-WIDE**,

**DOUBLE-HIGH**, and even

**DOUBLE-WIDE AND HIGH!**

The five LQ-850 fonts actually use the printing system's resident fonts. The font mode in the Epson emulation is 0. (The printing system does not automatically adjust character spacing.) If you do not need exact character spacing, you can improve the appearance of these fonts by changing to font mode 13. The printing system generates double-wide and double-high effects for these emulating fonts.

To use other printing system fonts, select them with font commands (FONT, SFNT, and FSET). Since the printing system emulates certain LQ-850 fonts in different spacings by using the same resident font, it should be noted that substituting one font will also change the other fonts emulated by that font. For example, if you change the Draft 15 cpi font which is emulated by the PrestigeEliteBM7.2-Roman font, this will also affect the other 15 cpi LQ-850 fonts using the same ALTF 7; setting.

Table 7.12. Epson LQ-850 Fonts (Sheet 1 of 2)

Font name	Character spacing	ALTF No.
Draft/Epson Courier	10 cpi, Proportional	0
	12 cpi	1
	15 cpi	7
	Condensed 10 cpi	8
	Condensed 12 cpi, Condensed proportional	9
Epson Roman	10 cpi, proportional	2
	12 cpi	3
	15 cpi	7
	Condensed 10 cpi	8
	Condensed 12 cpi, Condensed proportional	9
Epson Sans Serif	10 cpi, 12 cpi, proportional	4
	15 cpi	5
	Condensed 10 cpi	8
	Condensed 12 cpi, Condensed proportional	9



Table 7.12. Epson LQ-850 Fonts (Sheet 2 of 2)

Font name	Character spacing	ALTF No.
Epson Prestige	10 cpi, 12 cpi, Proportional	6
	15 cpi	7
	Condensed 10 cpi	8
	Condensed 12 cpi, Condensed proportional	9

You can alter these default SETF assignments to suit your own purposes. In the example below, four of the SETF assignments are changed to proportional fonts, and the font mode is changed to 15. The sample text is then printed by selecting pica for the title, elite for the first paragraph, compressed for the second paragraph, compressed elite for the third paragraph, and elite for the last paragraph.

```
!R! SETF 0, 12; CMNT Draft 10cpi: Swiss721BM12-Bold;
      SETF 1, 2; CMNT Draft 12cpi: Dutch801BM10-Roman;
      SETF 7, 13; CMNT Draft 15cpi: Swiss721BM8-Roman;
      SETF 8, 14; CMNT Condensed 10cpi: Swiss721BM6-Roman;
EXIT;
```

To select a scalable font for the SETF assignments, first assign a font number to the scalable font by sending the command SFNT commands to the printing system as shown below. The font number assigned should not duplicate a number already in use.

```
!R! SFNT 'Swiss742SWC-Bold', 12, 3000, 277, 1, 0;
      SFNT 'Dutch801SWC-Roman', 10, 3001, 277, 1, 0;
      SFNT 'Swiss742SWC-Roman', 8, 3002, 277, 1, 0;
      SFNT 'Swiss742SWC-Roman', 6, 3003, 277, 1, 0;
EXIT;
```

All option parameters for SFNT (including *symbol-set*, *compression*, and *angle*) are required for assigning font numbers to a scalable font when altering the SETF assignments for the Epson emulation.

Landscape printing is possible in the LQ-850 mode. If you send the command !R! SPOL; EXIT; the printing system rotates fonts and prints them in landscape orientation.

In portrait orientation, the printing system supports Epson bit-image graphics, so with graphics software for the LQ-850 printer, you can use it to print charts, graphs, and pictures. The 9-bit graphics mode is also supported.

If you attempt to print beyond the right margin, the characters wrap around and are printed on the next line.

## EPSON LQ-850 Control Codes

Table 7.13. Epson LQ-850 Control Codes

Command	Function	Code (hex)	Supported
<b>Printer Operation</b>			
ESC @	Initialize Printer	1B 40	Yes
DC 1	Select Printer	11	–
DC 3	Deselect Printer	13	–
DEL	Delete Character	7F	–
ESC <	Select Unidirectional Mode (one line)	1B 3C	Yes
ESC U n	Turn Unidirectional Mode On/Off	1B 55	–
<b>MSB Control</b>			
ESC EM n	Control Cut Sheet Feeder	1B 19	–
ESC =	Set MSB to 0	1B 3D	Yes
ESC >	Set MSB to 1	1B 3E	Yes
ESC #	Cancel MSB Control	1B 35	Yes
<b>Data Control</b>			
BEL	Beeper	07	–
CR	Carriage Return	0D	Yes
CAN	Cancel Line	18	–
<b>Vertical Motion</b>			
FF	Form feed	0C	Yes
ESC C n	Set Page Length in Lines	1B 43	Yes
ESC C null n	Set Page Length in Inches	1B 43 00	Yes
ESC N n	Set Skip Over Perforation	1B 4E	Yes
ESC O	Cancel Skip Over Perforation	1B 4F	Yes
LF	Line Feed	0A	Yes
ESC + n	Set n/360-inch Line Spacing	1B 2B	Yes
ESC 0	Select 1/8-inch Line Spacing	1B 30	Yes
ESC 2	Select 1/6-inch Line Spacing	1B 32	Yes
ESC 3 n	Set n/180-inch Line Spacing	1B 33	Yes
ESC A n	Set n/60-inch Line Spacing	1B 41	Yes
ESC J n	Perform n/180-inch Line Feed	1B 4A	Yes
VT	Tab Vertically	0B	Yes
ESC B n1 n2...n16 null	Set Vertical Tabs	1B 42	Yes
ESC b n1 n2...n16 null	Set Vertical Tabs in Channels	1B 62	Yes
ESC / n	Select Vertical Tab Channel	1B 2F	Yes
<b>Horizontal Motion</b>			
ESC / n	Set Left Margin	1B 6C	Yes
ESC Q n	Set Right Margin	1B 51	Yes
BS	Backspace	08	Yes
ESC \$ n1 n2	Set Absolute Print Position	1B 24	Yes
ESC \ n1 n2	Set Relative Print Position	1B 5C	Yes
HT	Tab Horizontally	09	Yes
ESC D n1 n2...n32 null	Set Horizontal Tabs	1B 44	Yes
<b>Overall Printing Style</b>			
ESC / n	Set Left Margin	1B 6C	Yes
ESC Q n	Set Right Margin	1B 51	Yes
BS	Backspace	08	Yes
ESC \$ n1 n2	Set Absolute Print Position	1B 24	Yes
ESC \ n1 n2	Set Relative Print Position	1B 5C	Yes
HT	Tab Horizontally	09	Yes
ESC D n1 n2...n32 null	Set Horizontal Tabs	1B 44	Yes
<b>Print Size and Character Width</b>			
ESC P	Select 10 CPI	1B 50	Yes

Table 7.13. Epson LQ-850 Control Codes

Command	Function	Code (hex)	Supported
ESC M	Select 12 CPI	1B 4D	Yes
ESC g	Select 15 CPI	1B 67	Yes
ESC p n	Turn Proportional Mode On/Off	1B 70	Yes
SI	Select Condensed Mode	0F	Yes
ESC SI	Select Condensed Mode	1B 0F	Yes
DC2	Cancel Condensed Mode	12	Yes
SO	Select Double-wide Mode (one line)	0E	Yes
ESC SO	Select Double-wide Mode (one line)	1B 0E	Yes
ESC W n	Turn Double-wide Mode On/Off	1B 57	Yes
DC4	Cancel Double-wide Mode (one line)	14	Yes
ESC w n	Turn Double-high Mode On/Off	1B 77	Yes
<b>Print Enhancement</b>			
ESC E	Select Emphasized Mode	1B 45	Yes
ESC F	Cancel Emphasized Mode	1B 46	Yes
ESC G	Select Double-strike Mode	1B 47	Yes
ESC H	Cancel Double-strike Mode	1B 48	Yes
ESC S n	Select Superscript or Subscript	1B 53	Yes
ESC T	Cancel Superscript/Subscript Mode	1B 54	Yes
ESC (- n1 n2 m d1 d2	Select Score	1B 28 2D	Yes
ESC - n	Turn Underline Mode On/Off	1B 2D	Yes
ESC q	Select Character Style	1B 67	Yes
<b>Word Processing</b>			
ESC a n	Select Justification	1B 61	–
ESC SP n	Set Intercharacter Space	1B 20	Yes
<b>Character Tables</b>			
ESC t n	Select Character Set	1B 74	Yes
ESC 4	Select Italic Mode	1B 34	Yes
ESC 5	Cancel Italic Mode	1B 35	Yes
ESC R	Select an International Character Set	1B 52	Yes
<b>User-defined Characters</b>			
ESC & null d1 d2...dn	Define User-defined Characters	1B 26	–
ESC : null n null	Copy ROM to RAM	1B 3A	–
ESC % n	Select User-defined Set	1B 25	–
ESC 6	Enable Printable Characters	1B 36	Yes
ESC 7	Enable Upper Control Codes	1B 37	Yes
<b>Graphics</b>			
ESC K n1 n2 v1 v2...vn	Select Single-density Graphics Mode	1B 4B	Yes
ESC L n1 n2 v1 v2...vn	Select Double-density Graphics Mode	1B 4C	Yes
ESC Y n1 n2 v1 v2...vn	Select High-speed Double-density Graphics Mode	1B 59	Yes
ESC Z n1 n2 v1 v2...vn	Select Quadruple-density Graphics Mode	1B 5A	Yes
ESC * m n1 n2 v1 v2...vn	Select Graphics Mode	1B 2A	Yes
ESC ? m n	Reassign Graphics Mode	1B 3F	Yes



LQ.U.K. (124)

0	1	2	3	4	5	6	7	8	9	A	B	C	D	E	F	
	0	1	2	3	4	5	6	7	8	9	A	B	C	D	E	F
	0	1	2	3	4	5	6	7	8	9	A	B	C	D	E	F
0	16	32	48	64	80	96	112	128	144	160	176	192	208	224	240	
1	17	33	49	65	81	97	113	129	145	161	177	193	209	225	241	
2	18	34	50	66	82	98	114	130	146	162	178	194	210	226	242	
3	19	35	51	67	83	99	115	131	147	163	179	195	211	227	243	
4	20	36	52	68	84	100	116	132	148	164	180	196	212	228	244	
5	21	37	53	69	85	101	117	133	149	165	181	197	213	229	245	
6	22	38	54	70	86	102	118	134	150	166	182	198	214	230	246	
7	23	39	55	71	87	103	119	135	151	167	183	199	215	231	247	
8	24	40	56	72	88	104	120	136	152	168	184	200	216	232	248	
9	25	41	57	73	89	105	121	137	153	169	185	201	217	233	249	
A	26	42	58	74	90	106	122	138	154	170	186	202	218	234	250	
B	27	43	59	75	91	107	123	139	155	171	187	203	219	235	251	
C	28	44	60	76	92	108	124	140	156	172	188	204	220	236	252	
D	29	45	61	77	93	109	125	141	157	173	189	205	221	237	253	
E	30	46	62	78	94	110	126	142	158	174	190	206	222	238	254	
F	31	47	63	79	95	111	127	143	159	175	191	207	223	239	255	

LQ Germany (92)

0	1	2	3	4	5	6	7	8	9	A	B	C	D	E	F	
	0	1	2	3	4	5	6	7	8	9	A <td>B</td> <td>C</td> <td>D</td> <td>E</td> <td>F</td>	B	C	D	E	F
	0	1	2	3	4	5	6	7	8	9	A <td>B</td> <td>C</td> <td>D</td> <td>E</td> <td>F</td>	B	C	D	E	F
0	16	32	48	64	80	96	112	128	144	160	176	192	208	224	240	
1	17	33	49	65	81	97	113	129	145	161	177	193	209	225	241	
2	18	34	50	66	82	98	114	130	146	162	178	194	210	226	242	
3	19	35	51	67	83	99	115	131	147	163	179	195	211	227	243	
4	20	36	52	68	84	100	116	132	148	164	180	196	212	228	244	
5	21	37	53	69	85	101	117	133	149	165	181	197	213	229	245	
6	22	38	54	70	86	102	118	134	150	166	182	198	214	230	246	
7	23	39	55	71	87	103	119	135	151	167	183	199	215	231	247	
8	24	40	56	72	88	104	120	136	152	168	184	200	216	232	248	
9	25	41	57	73	89	105	121	137	153	169	185	201	217	233	249	
A	26	42	58	74	90	106	122	138	154	170	186	202	218	234	250	
B	27	43	59	75	91	107	123	139	155	171	187	203	219	235	251	
C	28	44	60	76	92	108	124	140	156	172	188	204	220	236	252	
D	29	45	61	77	93	109	125	141	157	173	189	205	221	237	253	
E	30	46	62	78	94	110	126	142	158	174	190	206	222	238	254	
F	31	47	63	79	95	111	127	143	159	175	191	207	223	239	255	

LQ Spain (252)

	0	1	2	3	4	5	6	7	8	9	A	B	C	D	E	F
	à	á	â	ã	ä	å	æ	ç	è	é	ê	ë	ê	ë	æ	≡
0	à	á	â	ã	ä	å	æ	ç	è	é	ê	ë	ê	ë	æ	≡
1	è	é	ê	ë	æ	ç	è	é	ê	ë	æ	ç	è	é	ê	≡
2	ù	ú	û	ü	ý	ÿ	ÿ	ÿ	ÿ	ÿ	ÿ	ÿ	ÿ	ÿ	ÿ	ÿ
3	ò	ó	ô	õ	ö	ø	œ	ç	è	é	ê	ë	ê	ë	æ	≡
4	ì	í	î	ï	î	ï	î	ï	î	ï	î	ï	î	ï	î	ï
5	ó	ô	õ	ö	ø	œ	ç	è	é	ê	ë	ê	ë	æ	≡	ÿ
6	é	ê	ë	æ	ç	è	é	ê	ë	æ	ç	è	é	ê	ë	ÿ
7	í	î	ï	î	ï	î	ï	î	ï	î	ï	î	ï	î	ï	ÿ
8	ç	è	é	ê	ë	æ	ç	è	é	ê	ë	ê	ë	æ	ç	ÿ
9	ñ	ü	ÿ	ÿ	ÿ	ÿ	ÿ	ÿ	ÿ	ÿ	ÿ	ÿ	ÿ	ÿ	ÿ	ÿ
A	ñ	ü	ÿ	ÿ	ÿ	ÿ	ÿ	ÿ	ÿ	ÿ	ÿ	ÿ	ÿ	ÿ	ÿ	ÿ
B	œ	ç	è	é	ê	ë	æ	ç	è	é	ê	ë	ê	ë	æ	ÿ
C	ê	ë	æ	ç	è	é	ê	ë	æ	ç	è	é	ê	ë	æ	ÿ
D	á	â	ã	ä	å	æ	ç	è	é	ê	ë	ê	ë	æ	ç	ÿ
E	â	ã	ä	å	æ	ç	è	é	ê	ë	æ	ç	è	é	ê	ÿ
F	ç	è	é	ê	ë	æ	ç	è	é	ê	ë	ê	ë	æ	ç	ÿ

LQ Italy (220)

	0	1	2	3	4	5	6	7	8	9	A	B	C	D	E	F
	à	á	â	ã	ä	å	æ	ç	è	é	ê	ë	ê	ë	æ	≡
0	à	á	â	ã	ä	å	æ	ç	è	é	ê	ë	ê	ë	æ	≡
1	è	é	ê	ë	æ	ç	è	é	ê	ë	æ	ç	è	é	ê	≡
2	ù	ú	û	ü	ý	ÿ	ÿ	ÿ	ÿ	ÿ	ÿ	ÿ	ÿ	ÿ	ÿ	ÿ
3	ò	ó	ô	õ	ö	ø	œ	ç	è	é	ê	ë	ê	ë	æ	≡
4	ì	í	î	ï	î	ï	î	ï	î	ï	î	ï	î	ï	î	ï
5	ó	ô	õ	ö	ø	œ	ç	è	é	ê	ë	ê	ë	æ	ç	ÿ
6	é	ê	ë	æ	ç	è	é	ê	ë	æ	ç	è	é	ê	ë	ÿ
7	í	î	ï	î	ï	î	ï	î	ï	î	ï	î	ï	î	ï	ÿ
8	ç	è	é	ê	ë	æ	ç	è	é	ê	ë	ê	ë	æ	ç	ÿ
9	ñ	ü	ÿ	ÿ	ÿ	ÿ	ÿ	ÿ	ÿ	ÿ	ÿ	ÿ	ÿ	ÿ	ÿ	ÿ
A	ñ	ü	ÿ	ÿ	ÿ	ÿ	ÿ	ÿ	ÿ	ÿ	ÿ	ÿ	ÿ	ÿ	ÿ	ÿ
B	œ	ç	è	é	ê	ë	æ	ç	è	é	ê	ë	ê	ë	æ	ÿ
C	ê	ë	æ	ç	è	é	ê	ë	æ	ç	è	é	ê	ë	æ	ÿ
D	á	â	ã	ä	å	æ	ç	è	é	ê	ë	ê	ë	æ	ç	ÿ
E	â	ã	ä	å	æ	ç	è	é	ê	ë	æ	ç	è	é	ê	ÿ
F	ç	è	é	ê	ë	æ	ç	è	é	ê	ë	ê	ë	æ	ç	ÿ

LQ Norway (316)

	0	1	2	3	4	5	6	7	8	9	A	B	C	D	E	F
0	à	â	ä	å	æ	ç	é	ê	ë	é	á	â	ã	ä	å	≡
1	è	é	ê	ë	î	í	â	ä	å	æ	í	ï	î	ï	β	±
2	ù	û	ü	ÿ	z	z	b	r	é	æ	ó	ô	õ	ö	Γ	≥
3	ò	æ	#	3	C	S	c	s	â	ô	ú	í	í	í	π	≤
4	ì	ø	ø	ø	D	T	d	t	à	ö	ñ	í	í	í	Σ	∫
5	ó	ø	ø	ø	E	U	e	u	à	ò	ñ	í	í	í	F	J
6	£	"	&	&	F	V	f	v	á	û	á	û	û	û	μ	÷
7	i	ä	ï	ï	G	W	g	w	ç	ù	ó	ï	ï	ï	τ	≈
8	ï	ö	(	)	H	X	h	x	é	ÿ	¿	¿	¿	¿	Φ	°
9	ñ	ü	)	)	I	Y	i	y	è	ö	ó	ï	ï	ï	θ	·
A	ñ	ä	*	:	J	Z	j	z	è	ü	ó	ï	ï	ï	Ω	·
B	ö	ö	+	;	K	Æ	k	æ	ï	ç	½	½	½	½	δ	√
C	ü	ü	,	<	L	Ø	l	ø	î	é	¼	¼	¼	¼	∞	∞
D	å	é	-	=	M	Å	m	å	î	£	¼	¼	¼	¼	φ	2
E	å	é	.	>	N	Ü	n	ü	ä	£	¼	¼	¼	¼	ε	■
F	ç	¥	/	?	O	—	o	o	å	f	»	»	»	»	∩	∩

LQ Japan (284)

	0	1	2	3	4	5	6	7	8	9	A	B	C	D	E	F
0	à	â	ä	å	æ	ç	é	ê	ë	é	á	â	ã	ä	å	≡
1	è	é	ê	ë	î	í	â	ä	å	æ	í	ï	î	ï	β	±
2	ù	û	ü	ÿ	z	z	b	r	é	æ	ó	ô	õ	ö	Γ	≥
3	ò	æ	#	3	C	S	c	s	â	ô	ú	í	í	í	π	≤
4	ì	ø	ø	ø	D	T	d	t	à	ö	ñ	í	í	í	Σ	∫
5	ó	ø	ø	ø	E	U	e	u	à	ò	ñ	í	í	í	F	J
6	£	"	&	&	F	V	f	v	á	û	á	û	û	û	μ	÷
7	i	ä	ï	ï	G	W	g	w	ç	ù	ó	ï	ï	ï	τ	≈
8	ï	ö	(	)	H	X	h	x	é	ÿ	¿	¿	¿	¿	Φ	°
9	ñ	ü	)	)	I	Y	i	y	è	ö	ó	ï	ï	ï	θ	·
A	ñ	ä	*	:	J	Z	j	z	è	ü	ó	ï	ï	ï	Ω	·
B	ö	ö	+	;	K	l	k	l	ï	ç	½	½	½	½	δ	√
C	ü	ü	,	<	L	¥	l	¥	î	é	¼	¼	¼	¼	∞	∞
D	å	é	-	=	M	J	m	j	î	£	¼	¼	¼	¼	φ	2
E	å	é	.	>	N	^	n	^	ä	£	¼	¼	¼	¼	ε	■
F	ç	¥	/	?	O	—	o	o	å	f	»	»	»	»	∩	∩

LQ Spain 2 (380)

	0	1	2	3	4	5	6	7	8	9	A	B	C	D	E	F
0	à	á	â	ã	ä	å	æ	ç	ç	é	é	ë	ë	ë	ë	ë
1	è	é	ê	ë	ê	ë	æ	ç	ç	é	é	ë	ë	ë	ë	ë
2	ù	ú	û	ü	ü	ü	æ	ç	ç	é	é	ë	ë	ë	ë	ë
3	ò	ó	ô	õ	ö	ø	æ	ç	ç	é	é	ë	ë	ë	ë	ë
4	ì	í	î	ï	ï	ï	æ	ç	ç	é	é	ë	ë	ë	ë	ë
5	ó	ô	õ	ö	ø	ø	æ	ç	ç	é	é	ë	ë	ë	ë	ë
6	£	€	€	€	€	€	æ	ç	ç	é	é	ë	ë	ë	ë	ë
7	í	ä	ö	ö	ö	ö	æ	ç	ç	é	é	ë	ë	ë	ë	ë
8	¿	Ö	(	)	)	)	æ	ç	ç	é	é	ë	ë	ë	ë	ë
9	Ñ	Ü	)	*	*	*	æ	ç	ç	é	é	ë	ë	ë	ë	ë
A	ñ	ä	*	:	:	:	æ	ç	ç	é	é	ë	ë	ë	ë	ë
B	œ	ö	+	;	;	;	æ	ç	ç	é	é	ë	ë	ë	ë	ë
C	pt	ü	,	<	<	<	æ	ç	ç	é	é	ë	ë	ë	ë	ë
D	Å	É	-	=	=	=	æ	ç	ç	é	é	ë	ë	ë	ë	ë
E	å	é	.	>	>	>	æ	ç	ç	é	é	ë	ë	ë	ë	ë
F	ç	¥	/	?	?	?	æ	ç	ç	é	é	ë	ë	ë	ë	ë

LQ Denmark 2 (348)

	0	1	2	3	4	5	6	7	8	9	A	B	C	D	E	F
0	à	á	â	ã	ä	å	æ	ç	ç	é	é	ë	ë	ë	ë	ë
1	è	é	ê	ë	ê	ë	æ	ç	ç	é	é	ë	ë	ë	ë	ë
2	ù	ú	û	ü	ü	ü	æ	ç	ç	é	é	ë	ë	ë	ë	ë
3	ò	ó	ô	õ	ö	ø	æ	ç	ç	é	é	ë	ë	ë	ë	ë
4	ì	í	î	ï	ï	ï	æ	ç	ç	é	é	ë	ë	ë	ë	ë
5	ó	ô	õ	ö	ø	ø	æ	ç	ç	é	é	ë	ë	ë	ë	ë
6	£	€	€	€	€	€	æ	ç	ç	é	é	ë	ë	ë	ë	ë
7	í	ä	ö	ö	ö	ö	æ	ç	ç	é	é	ë	ë	ë	ë	ë
8	¿	Ö	(	)	)	)	æ	ç	ç	é	é	ë	ë	ë	ë	ë
9	Ñ	Ü	)	*	*	*	æ	ç	ç	é	é	ë	ë	ë	ë	ë
A	ñ	ä	*	:	:	:	æ	ç	ç	é	é	ë	ë	ë	ë	ë
B	œ	ö	+	;	;	;	æ	ç	ç	é	é	ë	ë	ë	ë	ë
C	pt	ü	,	<	<	<	æ	ç	ç	é	é	ë	ë	ë	ë	ë
D	Å	É	-	=	=	=	æ	ç	ç	é	é	ë	ë	ë	ë	ë
E	å	é	.	>	>	>	æ	ç	ç	é	é	ë	ë	ë	ë	ë
F	ç	¥	/	?	?	?	æ	ç	ç	é	é	ë	ë	ë	ë	ë



LQ Denmark (156)

	0	1	2	3	4	5	6	7	8	9	A	B	C	D	E	F
0	à	á	â	ã	ä	å	æ	ç	ê	ë	ñ	õ	ö	ø	ù	û
1	è	é	ê	ë	î	ï	ð	ø	é	ê	ë	ï	ï	ð	é	ê
2	ù	ú	û	ü	ý	ÿ	ÿ	ÿ	ÿ	ÿ	ÿ	ÿ	ÿ	ÿ	ÿ	ÿ
3	ò	ó	ô	õ	ö	ø	ù	ú	û	ü	ý	ÿ	ÿ	ÿ	ÿ	ÿ
4	î	ï	ð	ø	é	ê	ë	ï	ï	ð	é	ê	ë	ï	ï	ð
5	ó	ô	õ	ö	ø	ù	ú	û	ü	ý	ÿ	ÿ	ÿ	ÿ	ÿ	ÿ
6	£	"	&	'	(	)	9	Ñ	Ü	ü	ÿ	ÿ	ÿ	ÿ	ÿ	ÿ
7	i	ä	ö	ü	ÿ	ÿ	ÿ	ÿ	ÿ	ÿ	ÿ	ÿ	ÿ	ÿ	ÿ	ÿ
8	í	ó	õ	ö	ø	ù	ú	û	ü	ý	ÿ	ÿ	ÿ	ÿ	ÿ	ÿ
9	ñ	ü	ÿ	ÿ	ÿ	ÿ	ÿ	ÿ	ÿ	ÿ	ÿ	ÿ	ÿ	ÿ	ÿ	ÿ
A	ñ	ä	*	:	J	Z	j	z	æ	í	ç	¼	½	¾	∞	∞
B	ð	ö	+	;	K	Æ	k	æ	i	ç	¼	½	¾	∞	∞	∞
C	Þ	ü	,	<	L	Ø	ø	∅	â	î	ñ	õ	ö	ø	ù	ú
D	Å	É	-	=	M	Å	m	å	î	ñ	õ	ö	ø	ù	ú	û
E	å	é	.	>	N	^	ˆ	ˆ	ˆ	ˆ	ˆ	ˆ	ˆ	ˆ	ˆ	ˆ
F	Ç	Ɔ	/	?	O	_	¸	¸	¸	¸	¸	¸	¸	¸	¸	¸

Latin America (412)

	0	1	2	3	4	5	6	7	8	9	A	B	C	D	E	F
0	à	á	â	ã	ä	å	æ	ç	ê	ë	ñ	õ	ö	ø	ù	û
1	è	é	ê	ë	î	ï	ð	ø	é	ê	ë	ï	ï	ð	é	ê
2	ù	ú	û	ü	ý	ÿ	ÿ	ÿ	ÿ	ÿ	ÿ	ÿ	ÿ	ÿ	ÿ	ÿ
3	ò	ó	ô	õ	ö	ø	ù	ú	û	ü	ý	ÿ	ÿ	ÿ	ÿ	ÿ
4	î	ï	ð	ø	é	ê	ë	ï	ï	ð	é	ê	ë	ï	ï	ð
5	ó	ô	õ	ö	ø	ù	ú	û	ü	ý	ÿ	ÿ	ÿ	ÿ	ÿ	ÿ
6	£	"	&	'	(	)	9	Ñ	Ü	ü	ÿ	ÿ	ÿ	ÿ	ÿ	ÿ
7	i	ä	ö	ü	ÿ	ÿ	ÿ	ÿ	ÿ	ÿ	ÿ	ÿ	ÿ	ÿ	ÿ	ÿ
8	í	ó	õ	ö	ø	ù	ú	û	ü	ý	ÿ	ÿ	ÿ	ÿ	ÿ	ÿ
9	ñ	ü	ÿ	ÿ	ÿ	ÿ	ÿ	ÿ	ÿ	ÿ	ÿ	ÿ	ÿ	ÿ	ÿ	ÿ
A	ñ	ä	*	:	J	Z	j	z	æ	í	ç	¼	½	¾	∞	∞
B	ð	ö	+	;	K	Æ	k	æ	i	ç	¼	½	¾	∞	∞	∞
C	Þ	ü	,	<	L	Ø	ø	∅	â	î	ñ	õ	ö	ø	ù	ú
D	Å	É	-	=	M	Å	m	å	î	ñ	õ	ö	ø	ù	ú	û
E	å	é	.	>	N	^	ˆ	ˆ	ˆ	ˆ	ˆ	ˆ	ˆ	ˆ	ˆ	ˆ
F	Ç	Ɔ	/	?	O	_	¸	¸	¸	¸	¸	¸	¸	¸	¸	¸

LQ Sweden (188)

0	1	2	3	4	5	6	7	8	9	A	B	C	D	E	F
0	à	á	â	ã	ä	å	ç	ç	é	é	é	é	é	é	é
1	è	é	ê	ë	ä	å	ü	ü	æ	í	í	í	í	í	í
2	ù	æ	2	B	R	b	r	é	æ	ó	ó	ó	ó	ó	ó
3	ò	æ	3	C	S	c	s	â	ô	ú	ú	ú	ú	ú	ú
4	ì	ø	4	D	T	d	t	ä	ö	ñ	ñ	ñ	ñ	ñ	ñ
5	ó	ø	5	E	U	e	u	à	ò	ñ	ñ	ñ	ñ	ñ	ñ
6	£	"	&	6	F	f	v	å	û	á	á	á	á	á	á
7	í	Á	7	G	W	g	w	ç	ù	°	°	°	°	°	°
8	ì	ò	(	8	H	h	x	é	ÿ	¿	¿	¿	¿	¿	¿
9	ñ	ü	)	9	I	y	i	ë	ö	¸	¸	¸	¸	¸	¸
A	ñ	ä	*	:	J	j	z	è	ü	¸	¸	¸	¸	¸	¸
B	ø	ö	+	;	K	k	ä	ï	ç	½	½	½	½	½	½
C	ø	ü	,	<	L	ö	l	ö	î	¼	¼	¼	¼	¼	¼
D	Å	É	-	=	M	å	m	å	ï	¾	¾	¾	¾	¾	¾
E	å	é	.	>	N	ü	n	ü	Ä	«	«	«	«	«	«
F	ç	£	/	?	O	—	o	—	å	»	»	»	»	»	»

# HP LaserJet Emulation (Mode 6)

On shipment from the factory, the printing system is set to power up in the HP LaserJet (PCL 6) emulation. The Kyocera printing systems support to emulate the following HP printer language as tabled below:

*Table 7.14. HP LaserJet Emulation by Model*

No.	Model	Printer Language	Resolution (dpi)	Fonts
1	FS-1000	PCL6, KPDL (Optional)	600, 300	AGFA80 Fonts
2	FS-1000+	PCL6, KPDL (Optional)	600, 300	AGFA80 Fonts
3	FS-1010	PCL 6, KPDL	Fast 1200, 600, 300	AGFA80 Fonts
4	FS-1050	PCL 6, KPDL	Fast 1200, 600, 300	AGFA80 Fonts
5	FS-1200	PCL 6, KPDL	600, 300	AGFA80 Fonts
6	FS-1714M	PCL 6, KPDL	Fine 1200, Fast 1200, 600, 300	AGFA80 Fonts
7	FS-1750	PCL 6, KPDL	Fine 1200, Fast 1200, 600, 300	AGFA80 Fonts
8	FS-1800	PCL 6, KPDL	Fine 1200, Fast 1200, 600, 300	AGFA80 Fonts
9	FS-1800+	PCL 6, KPDL	Fine 1200, Fast 1200, 600, 300	AGFA80 Fonts
10	FS-1900	PCL 6, KPDL	Fine 1200, Fast 1200, 600, 300	AGFA80 Fonts
11	FS-3718M	PCL 6, KPDL	Fine 1200, Fast 1200, 600, 300	AGFA80 Fonts
12	FS-3750	PCL 6, KPDL	Fine 1200, Fast 1200, 600, 300	AGFA80 Fonts
13	FS-3800	PCL 6, KPDL	Fine 1200, Fast 1200, 600, 300	AGFA80 Fonts
14	FS-5900C	PCL 5C, KPDL	1200 (KPDL), 600	Bitstream45
15	FS-6900	PCL 6, KPDL	600, 300	Bitstream45
16	FS-8000C	PCL 5C, KPDL 3	600 (bi-level), 600 (Contone)	AGFA161
17	FS-9100DN	PCL 6C, KPDL 3	Fast 1200, 600, 300	AGFA161
18	FS-9500DN	PCL 6C, KPDL 3	Fast 1200, 600, 300	AGFA161
19	KM-C830	PCL 5C, KPDL 3	600 (bi-level), 600 (Contone)	AGFA161
20	KM-1510	PCL 6, KPDL	600, 300	AGFA80 Fonts
21	KM-1530	PCL 6, KPDL	600, 300	AGFA80 Fonts
22	KM-1810	PCL 6, KPDL	600, 300	AGFA80 Fonts
23	KM-2030	PCL 6, KPDL	600, 300	AGFA80 Fonts
24	KM-2530	PCL 6C, KPDL 3	Fast 1200, 600, 300	AGFA161
25	KM-3530	PCL 6C, KPDL 3	Fast 1200, 600, 300	AGFA161
26	KM-4230	PCL 6, KPDL	600	AGFA80 Fonts
27	KM-5230	PCL 6, KPDL	600	AGFA80 Fonts
28	KM-6230	PCL 6, KPDL	600	AGFA80 Fonts

The factory default symbol set is PC-8. To change this default symbol set, use the FRPO command with the U6 and U7 parameters. The default font is Courier.

To set the printing system to power up in LaserJet mode, send the following PRE-SCRIBE command:

```
!R! FRPO P1, 6; FRPO P3, 1; EXIT;
```

To use the TimesNewRoman font of 14.25 points as the default font, add the following lines:

```
FRPO V3, 'TimesNewRoman';
FRPO V1, 14;
FRPO V2, 25;
```

See *Chapter 6* for details of the FRPO V parameters.

The symbol set can be changed after power-up with the CSET or INTL command, or from the operator panel keys, or with LaserJet symbol sets typically accessed through software.

The printing system also supports as many HP symbol sets as the LaserJet regularly supports and still other symbol sets can be provided in downloaded fonts. (A full list of the supported symbol sets appear in section *LaserJet Symbol Sets* on page 37.) These symbol sets can be used by appropriate font selection commands as explained below.

Fonts can be selected with PRESCRIBE commands, or through the printer driver provided with your software. The following font sample was created through driver support.

Figure 7. 15. HP LaserJet Word-Processing Printout

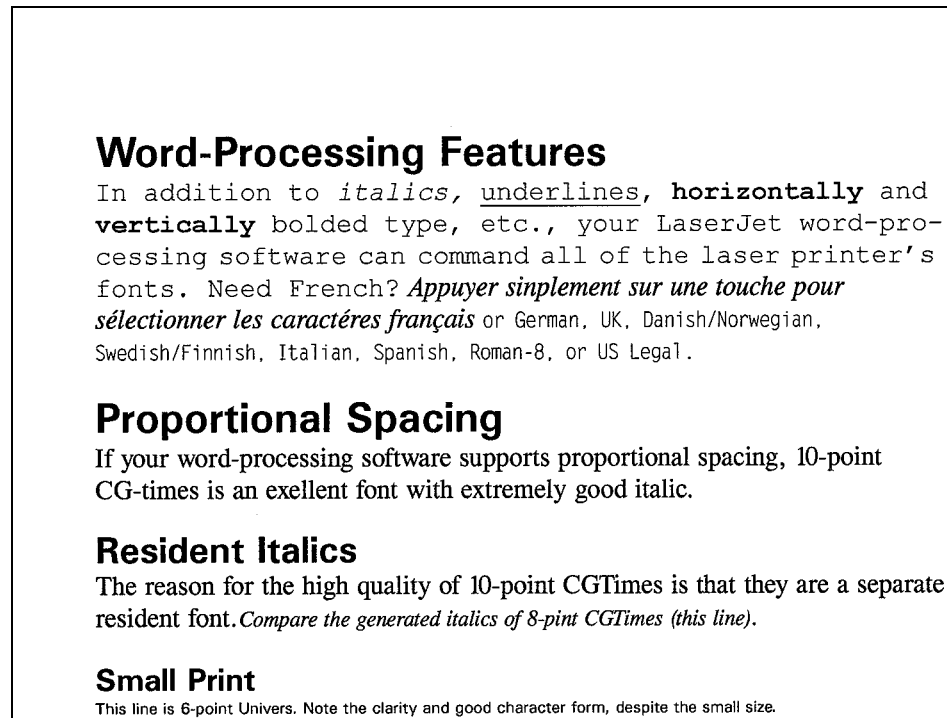

Additional *soft* fonts can be downloaded from external sources before printing begins. The printing system selects the fonts by a set of command codes (escape sequences) that describe the font attributes: character height, orientation, weight, character set, etc. (similar to the parameters used with the FSET command of PRESCRIBE). The printing system's resident fonts include the HP resident fonts and many of the fonts from the HP font cartridges.

The printing system supports the same soft fonts as the HP LaserJet printers. In addition, the printing system understands the LaserJet command codes and can use them to select any of its resident or downloaded fonts.

Since the LaserJet font selection codes are fairly complex (Refer to *LaserJet Font Selection* section.), software that supports the Laser Jet usually provides a simplified set of font selection commands which the software translates into LaserJet command codes.

Software-provided font selection commands will work for the printing system as they would for the HP LaserJet series printers. If a requested font is not present in the printing system's memory, the page printing system will choose from the characteristics of the closest matching font.

The LaserJet emulation supports 600/1200 dpi raster graphics for printing system models with the 300/600/1200 dpi resolution support. There is also support of delta row compression and compressed raster data for run length encoding and TIFF.

The printing system supports the LaserJet vector graphics, which draw vertical or horizontal ruled lines and create rectangles filled with a pattern or gray scale.

The margins in this emulation differ from the *A* parameters of the FRPO command. They recognize the page size of the default cassette. If you attempt to print beyond the right margin, the characters will be discarded.

Cassette size	Line per page	Character per line
Letter	60	80
A4	64	77

(Assuming 6 lines per inch and 10 characters per inch)

The proportional spacing is not identical to the LaserJet's proportional spacing. Right-margin justification may not be correct when using the LaserJet printer driver (when a LaserJet driver is selected within the application software).

## LaserJet Fonts

The printing system emulates the LaserJet fonts as listed below.

*Table 7.16. LaserJet Fonts*

No.	HP LaserJet Font	Kyocera Font	Style	Type Face Number
1	Arial	Arial	Medium, Bold, Italic, BoldItalic	16602
2	TimesNewRoman	TimesNewRoman	Medium, Bold, Italic, BoldItalic	16901
3	Symbol	Symbol	Medium	16686
4	Wingdings	Wingdings	Medium	31402
5	CG Times	CG Times	Medium, Bold, Italic, BoldItalic	4101
6	Univers	Univers-Md	Medium, Bold, Italic, BoldItalic	4148
7	Univers Cond	Univers-Cd	Medium Condensed, Bold Condensed, Italic Condensed, BoldItalic Condensed	4148
8	Courier	Courier	Medium, Bold, Italic, BoldItalic	4099
9	Letter Gothic	Letter Gothic	Medium, Bold, Italic	4102
10	Albertus	Albertus-Md	Medium, ExtraBold	4362
11	Antique Olive	Antique Olive	Medium, Bold, Italic	4168
12	Clarendon Cond	Clarendon-Cd	BoldCondensed	4140
13	Coronet	Coronet	Italic	4116
14	Garamond	Garamond	Antiqua, Halbfett, Kursiv, KursivHalbfett	4197
15	Marigold	Marigold	Medium	4297
16	CG Omega	CG Omega	Medium, Bold, Italic, BoldItalic	4113

### LaserJet Font Selection

#### Font Selection

Resolution does not effect the availability of scalable fonts. Bitmap fonts generated by LDFC present one limitation. If the printing system uses a 300-dpi resolution, LDFC-generated 600 dpi bitmap fonts may not be used. Whether these 600 dpi bitmaps are

LDFC fonts or downloaded bitmap fonts by the user, they will constantly print unpredictably if the printing system uses the resolution of 300 dpi.

### Font Priority

On the printing systems with the 600/1200 dpi resolution support, font selection in the HP LaserJet format adds an additional step to the font prioritization format. In font selection, the printing system evaluates the characteristics of the font and, by a process of matching features, reduces selection to a single font. The highest priority characteristic is symbol set, followed by spacing, pitch, point size, font style, stroke weight, and typeface. The LaserJet emulation (mode 6) adds resolution to this priority list. This additional priority is not available in the printing systems not supporting the 600/1200 dpi resolutions.

For example, the printing system might face a font selection scenario of four near identical types of the Dutch801 font (by the KPDLE emulation):

- CGTimes (LaserJet compatible Intelli font)
- Times (PostScript compatible font)
- TimesNewRoman (LaserJet compatible TrueType font)

These fonts have several common attributes and there is a possibility that selecting a Times may insert the TimesNewRoman font instead as a result of the internal font evaluation procedure. It is therefore important to understand how fonts are selected by the printing system. (See *Chapter 4* for a discussion of the printing system's internal font evaluation.)

The final (lowest) priority for font priority is the font source. The source refers to the place where the font is accessed. The following table shows how this characteristic is ordered.

Ordering priority	Source	Priority within same source
1	Downloaded and LDFC-generated fonts	Smaller font ID
2	Memory card fonts	Top slot > bottom slot
3	Resident and optional fonts	Alphabetic order

Users should note two differences in the source priority of font selection. Ordering priority 1 uses the original HP method whereby the internal number assigned to a font would be evaluated and the lowest number given the higher priority. This method applies to fonts downloaded to the printing system and, any LDFC-generated fonts. Ordering priority 3 evaluates the font in alphabetic order. This method applies to the resident fonts and the KPDLE fonts.

An FRPO command (FRPO C8;) can modify this evaluation method by turning off evaluation of either the resident or scalable fonts, or KPDLE fonts or both. The resident scalable fonts are not affected by this FRPO command. These fonts were designed by Agfa and observe the alphabetic ordering method used by Agfa.

### Regular and Dark Courier/Letter Gothic

The stroke weight (bolding) of Courier and Letter Gothic is changeable between regular and dark. The default is regular and matches the Hewlett-Packard. It can be changed to dark which was the default stroke weight of Courier and Letter Gothic in order Kyocera printing systems by changing the FRPO V9 parameter.

## LaserJet Font Escape Sequences

The example below shows an HP font selection escape sequence that selects a LetterGothic font with fixed-pitch, 12-cpi, 12-point, upright-style, normal stroke weight.

Characteristic	Value (example)	Escape Sequence
Symbol set	Roman-8	ESC(8U
Spacing	Fixed	ESC(s0P
Pitch	12-cpi	ESC(s12H
Height	12-point	ESC(s12V
Style	Upright	ESC(s0S
Stroke weight	Normal	ESC(s0B
Typeface	Letter Gothic	ESC(s4102T

To select this LetterGothic font, send the following escape sequence to the printing system:

```
ESC(8U ESC(s0P ESC(s12H ESC(s12V ESC(s0S ESC(s0B ESC(s4102T
```

Any escape sequence with two similar consecutive letters after the ESC parameter can be combined as in the transformation of the LetterGothic font below:

```
ESC(8U ESC(s0p12h12v0s0b4102T
```

The FSET command of PRESCRIBE utilizes a similar font selection method. (The symbol set selection is made with the CSET command.) Note the similarities in the FSET command sequence below:

```
FSET 0p12h12v0s0b4102T;
```

Several other LaserJet codes should be considered for font management. See the Font Management section of the HP LaserJetPrinter commands on page 56 and onwards.

## LaserJet Symbol Sets

Symbol set has the highest priority in the HP font selection. The factory default symbol set is IBM PC-8 (10U) for the LaserJet emulation. The LaserJet printer has many other symbol sets not directly accessed by the INTL command. Temporary selection of one of these symbol sets can be made with the CSET (Change symbol SET) command or from the operator panel keys. You can also assign one of these symbol sets to a particular font using the FSET (change current Font SETting) command. More information on these commands appear in *Chapter 4*.

By giving a particular value for the FRPO U6 and U7 parameters, you can set one of the HP symbol sets as the power-up symbol set. In general, symbol set value is:

(Escape sequence value field value  $\times$  32 + (Decimal value of escape sequence termination character - 64)  $[(U7 - 50) \times 100 + U6]$ )

### *Symbol Sets for Bitmap Fonts*

The printing system substitutes with a scalable font when a bitmap font is required for downward compatibility. The following symbol sets are supported when substituted bitmap fonts are in use. To power up the printing system in one of these symbol set, use the following FRPO U6 and U7 values.

**Table 7.17. Symbol Sets for Bitmap Fonts**

Symbol Set	HP Symbol Set ID (Value)	FRPO U6 Value	FRPO U7 Value
ISO 60 Norway	0D (4)	4	50
HP Extension	0E (5)	5	
ISO 25 France	0F (6)	6	
HP German	0G (7)	7	
ISO 15 Italian	0I (9)	9	
ISO 14 Japan	0K (11)	11	
ECMA-94 Latin 1	0N (14)	14	
ISO 11 Sweden	0S (19)	19	
ISO 6 ASCII	0U (21)	21	
ISO 61 Norway	1D (36)	36	
ISO 4 U.K.	1E (37)	37	
ISO 69 France	1F (38)	38	
ISO 21 Germany	1G (39)	39	
HP Spanish	1S (51)	51	
US Legal	1U (53)	53	
ISO 57 China	2K (75)	75	
ISO 17 Spain	2S (83)	83	50
ISO 2 IRV	2U (85)	85	50
ISO 10 Sweden	3S (115)	15	51
ISO 16 Portugal	4S (147)	47	51
Roman-9	4U (179)	79	51
ISO 84 Portugal	5S (179)	79	51
ISO 85 Spain	6S (211)	11	52
PC Set 1	8Q (273)	73	52
HP Roman-8	8U (277)	77	52
PC Extension	9Q (305)	5	53
IBM PC-8	10U (341)	41	53
IBM PC-8 (D/N)	11U (373)	73	53
IBM PC-850	12U (405)	5	54
PC-858	13U (437)	37	54

## Symbol Sets for Scalable Fonts

The following table lists symbol set support for resident scalable fonts. To power up the printing system in one of these symbol set, use the following FRPO U6 and U7 values.

**Table 7.18. Symbol Sets for Scalable Fonts (Sheet 1 of 2)**

Symbol Set	HP Symbol Set ID (Value)	FRPO U6 Value	FRPO U7 Value
ISO 60 Norway	0D (4)	4	50
ISO 15 Italian	0I (9)	9	
ECMA-94 Latin 1	0N (14)	14	
ISO 11 Sweden	0S (19)	19	
ISO 6 ASCII	0U (21)	21	
ISO 4 U. K.	1E (37)	37	
ISO 69 France	1F (38)	38	
ISO 21 Germany	1G (39)	39	
US Legal	1U (53)	53	
ISO Latin 2	2N (78)	78	
ISO 17 Spain	2S (83)	83	



Table 7.18. Symbol Sets for Scalable Fonts (Sheet 2 of 2)

Symbol Set	HP Symbol Set ID (Value)	FRPO U6 Value	FRPO U7 Value
PC Cyrillic	3R (114)	14	51
PS math	5M (173)	73	
ISO Latin 5	5N (174)	74	
Windows Latin 5	5T (180)	80	
MS Publishing	6J (202)	2	52
ISO Latin 6	6N (206)	6	
Desktop	7J (234)	34	
Greek-8	8G (263)	63	
Math-8	8M (269)	69	
Turkish-8	8T (276)	76	
HP Roman-8	8U (277)	77	
Windows Latin 2	9E (293)	93	
Windows Greek	9G (295)	95	
PC-1004	9J (298)	98	
ISO Latin 9	9N (302)	2	53
Win Cyrillic	9R (306)	6	
PC Turkish	9T (308)	8	
Windows	9U(309)	9	
PC-851 Greek	10G (327)	27	
PS text	10J (330)	30	
ISO Cyrillic	10N (334)	34	
PC-855 Serbia	10R (338)	38	
IBM PC-8	10U (341)	41	
PC-869 Greek	11G (359)	59	
IBM PC-8 D/N	11U (373)	73	
PC-8 Greek	12G (391)	91	
Macintosh	12J (394)	94	
ISO Greek	12N (398)	98	
USSR-GOST	12R (402)	2	54
IBM PC-850	12U (405)	5	
ABICOMP Brazil	13P (432)	32	
PC-8 Bulgarian	13R (434)	34	
PC-8 Greek/ 437G	14G (455)	55	
ABICOMP Int.	14P (464)	64	
PC Ukrainian	14R (466)	66	
Pi Font	15U (501)	1	55
PC-857 Turkish	16U (533)	33	
PC-852 Latin 2	17U (565)	65	
ISO-10646	18N (590)	90	
PC-853 Turkish	18U (597)	97	
WinBalt	19L (620)	20	56
Windows Latin 1	19U (629)	29	
PC-860 Portugal	20U (661)	61	
PC-861 Iceland	21U (693)	93	
PC-863 Canada	23U (757)	57	57
PC-8 Polish	24Q (785)	85	
PC-865 Norway	25U (821)	21	58
PC-775	26U (853)	53	
PC-8 PC Nova	27Q (881)	81	

*Example:*

To power up in the TimesNewRoman font for the Windows symbol set:

```
!R! FRPO V3, 'TimesNewRoman';
      FRPO U6, 9; FRPO U7, 53;
      STAT;
EXIT;
```

The STAT command in the third line prints a status page that enables the user to confirm changes made with the preceding sequences. The power-up font and symbol set are shown in the *Interfaces* section.

## Resource Protection

The resource protection feature is Kyocera's implementation of the HP's *resource saving*. The feature preserves resources during emulation switching. The protected resources, user-defined symbol sets and patterns, fonts, and macros, remain intact when the user switches to and from the HP LaserJet emulation.

A permanent default can be set for resource protection using the following FRPO command:

```
!R! FRPO N9, 1; EXIT; or !R! FRPO N9, 2; EXIT;
```

The MENU key on the printing system's control panel may also be used to establish resource protection.

The following table summarizes the features and functions of the resource protection mode in the HP LaserJet emulation.

*Table 7.19. Resource Protection and FRPO N9 Value*

Resource (Property)	Emulation	N9 = 0	N9 = 1	N9 = 2
Soft fonts (Permanent)	HPLJ	Deleted	Retained	Retained
Soft fonts (Temporary)	HPLJ	Deleted	Deleted	Retained
Macros (Permanent)	HPLJ	Deleted	Retained	Retained
Macros (Temporary)	HPLJ	Deleted	Deleted	Retained
User patterns (Permanent)	HPLJ	Deleted	Retained	Retained
User patterns (Temporary)	HPLJ	Deleted	Deleted	Retained
User symbol set (Permanent)	HPLJ	Deleted	Retained	Retained
User symbol set (Temporary)	HPLJ	Deleted	Deleted	Retained
Print environment	HPLJ	Deleted	Deleted	Retained
Permanent dictionary	KPDL	Retained	Retained	Retained

A detailed description of the FRPO N9 command follows. Note that the factory default setting for the N9 command is 0.

N9 = 0, resource protection is off. No resources will be protected during emulation switching, regardless of whether they are temporary or permanent. When the user returns to the mode 6 emulation, the print environment will be reset. The print environment includes items such as number of copies, orientation, and margins.

- N9 = 1, permanent PCL resources are protected. The printing system will store in memory all resources marked as permanent (soft fonts, macros, user patterns and symbol sets) and protect these resources during emulation switching. All resources marked as temporary (soft fonts, macros, user patterns, and symbol sets) will be lost during emulation switching. The print environment will be reset when it is returned to the mode 6 emulation.
- N9 = 2, permanent and temporary PCL resources are protected. The printing system will store in memory all resources, both temporary and permanent, and protect them during emulation switching. Instead of resetting the mode 6 environment upon switching back, the printing system will restore the previous print environment. This option demands a large share of printing system memory.

Resource protection becomes operational under any of the following emulation switching conditions:

- An SEM command is sent to the printing system.
- The emulation is changed by the user from the operator panel keys.
- An automatic emulation sensing (AES) function is used for switching between KPD L and PCL.
- An HP LaserJet P J L command @P J L ENTER LANGUAGE = ?? is received.

The KPD L permanent dictionary is always protected, regardless of the values for N9.

The amount of memory saved under resource protection is limited by the user memory available. Resource protection requires extra memory for storing downloaded fonts and macros. This memory requirement extends beyond the standard memory that accompanies the printing system. The requirement varies based upon optional features installed in the printing system.

Note that a print environment using resource protection but whose space has been limited by user memory items like macros, symbol sets and fonts, will render the resource protection feature non-operational.

The property value (temporary or permanent) assigned to a resource must be given in the PCL command language. PRESCRIBE provides no commands for making a temporary or permanent designation. As a result, resource protection mode applies only to those resources generated with the HP PCL command language. A description of the memory requirements and property values for typical models appear in the following table.

### Minimum memory requirement for Resource Protection

The following tables are memory requirements for typical printing system models. For information on memory requirement on other printing system models, refer to the operation manual supplied with the printing system.

Table 7.20. Example: FS-1000 Series

Printing Condition	Resolution	
	300 dpi	600 dpi
HPLJ 4	2 Mbytes	2 Mbytes
HPLJ 4, duplex mode=None, raster memory=A4/Letter	2 Mbytes	6 Mbytes
HPLJ 4, duplex mode=None, raster memory=Legal	2 Mbytes	7 Mbytes
HPLJ 4, duplex mode=on, raster memory=A4/Letter	3 Mbytes	10 Mbytes

Table 7.20. Example: FS-1000 Series

Printing Condition	Resolution	
	300 dpi	600 dpi
HPLJ 4, duplex mode=on, raster memory=Legal	3 Mbytes	11 Mbytes
HPLJ 4/KPDL, duplex mode=None, raster memory=A4/Letter	2 Mbytes	6 Mbytes
HPLJ 4/KPDL, duplex mode=None, raster memory=Legal	2 Mbytes	7 Mbytes
HPLJ 4/KPDL, duplex mode=on, raster memory=A4/Letter	3 Mbytes	10 Mbytes
HPLJ 4/KPDL, duplex mode=on, raster memory=Legal	3 Mbytes	11 Mbytes
HPLJ 4/KPDL, resource protection, duplex mode=None	10 Mbytes	10 Mbytes
HPLJ 4/KPDL, resource protection, duplex mode=on	14 Mbytes	14 Mbytes

Table 7.21. Example: FS-9500DN

Printing Condition	Resolution			
	300 dpi	600 dpi	1200 dpi	
			Fast mode	Fine mode
PCL 6, duplex mode=None	8 MB	8 MB	8 MB	8 MB
PCL 6, duplex mode=On	8 MB	8 MB	8 MB	12 MB
KPDL, duplex mode=None	8 MB	8 MB	8 MB	8 MB
KPDL, duplex mode=On	8 MB	8 MB	12 MB	12 MB
PCL 6/KPDL resource protection, duplex mode=None	—	10 MB	10 MB	10 MB
PCL 6/KPDL, resource protection, duplex mode=On	—	14 MB	14 MB	14 MB

## Switching the Print Resolution

Because the printing systems with the 1200 dpi resolution support print at 300, 600, 1200 dpi, the printing system provides an FRPO command to establish a default at either level of resolution.

For fine 1200 dpi resolution, command:

```
!R! FRPO N8, 3; EXIT;
```

For 600 dpi resolution, command:

```
!R! FRPO N8, 1; EXIT;
```

For 300 dpi resolution, command:

```
!R! FRPO N8, 0; EXIT;
```

When the printing resolution is changed between 1200 dpi, 600 dpi, and 300 dpi, the printing system loads the PJI current environment values.

In addition to the FRPO N8 command as explained above, printing systems that permit the resolution to be set at either 300, 600, or 1200 are provided with the RESL (change RESoLution) command which switches the resolution on the fly. For details about this command, refer to *PRESCRIBE Commands Command Reference*.



Note

The amount of available printing system memory will determine whether the 600/1200 dpi default can be effective. If factors such as resource protection, duplexing, and raster memory reduce memory too low, then the printing system will remain at 300 dpi resolution.

## HP LaserJet Reset State

The printing system resets to the following states when it receives a PCL reset command. Shown in parentheses are the related FRPO parameters.

*Table 7.22. HP LaserJet Emulation Reset State*

Job control	Number of copies	1	
Page control	Cassette	Upper (R4)	
	Orientation	Portrait (C1)	
	Paper size	Installed tray size (R2)	
	VMI	6 lpi (U0/U1)	
	HMI	10 cpi	
	Top margin	50 dots	
	Text length	Paper size – (1/2-inch top + 1/2-inch bottom)	
	Left margin	Left logical	
	Right margin	Right logical	
	Perforation skip	On	
	Line termination	CR=CR, LF=LF, FF=FF	
	Fonts	Font	Courier
		Symbol set	IBM PC-8 (U6/U7)
Underline mode		Off	
Font management	Font id	0	
	Character code	0	
Raster graphics	Raster graphics resolution	75	
Rectangular area fill	Horizontal rectangle size	0	
	Vertical rectangle size	0	
	Area fill id	0	
Macro	Macro id	0	
Troubleshooting command	End of line wrap	Off	
	Display functions	Off	

## LaserJet PJJ

The HP LaserJet emulation loads a Printer Job Language (PJJ) that controls communication between the printing system and the system. The PJJ works for both KPDL and HP LaserJet emulations. It enables the user to change some default states but, more importantly, allows current printing system states to be communicated back to the host system.

The Kyocera printing systems described in this manual support only a subset of the HP PJJ commands. To check supported PJJ features, see the table that follows.

*Table 7.23. Supported PJJ Commands*

Command Group	Command	Description
Kernel Commands	Universal Exit Language (UEL)	Exits current printer language and returns control to PJJ. Reset the PJJ parser to start at the beginning of the line.
	COMMENT	Tells PJJ to accept the command line as a comment.
	ENTER	Chooses a printer language for processing the current job.
Job Separation Commands	JOB	Informs printing system of the start of a print job, resets the page count, allows naming of the job, supports non-printing mode for printing portions of jobs.
	EOJ	Instructs printing system that the print job is complete, resets the page count.

Table 7.23. Supported PJI Commands

Command Group	Command	Description
Environment Commands	DEFAULT	Sets default for environment variables.
	SET	Sets an environment variable to a specified value during a PJI job.
	INITIALIZE	Resets current and default PJI variables to factory default.
	RESET	Defaults current PJI variables.
Status Readback Commands	INQUIRE	Requires the current value for a specified environment variable.
	DINQUIRE	Requires the default value for a specified environment variable.
	ECHO	Returns the <i>&lt;words&gt;</i> portion of the command to the host computer.
	INFO	Requests a specified category of printing system information, such as printing system model, available printing system memory, configuration, status, environment variables, and unsolicited status variables.
	USTATUS	Allows printing system to send unsolicited status messages for device status changes, end-of-job status, and the number of pages printed. Status can be sent at specified time intervals.
	USTATUSOFF	Deactivates all unsolicited status.
Device Attendance Commands	RDYMSG	Specifies a message that replaces the Processing message on the message display. Shown in offline state if the printing system is processing data (except in mode selection).
	OPMSG	Displays specified message on the message display and sets printing system offline.
	STMSG	Displays specified message on the message display and sets printing system offline. If status readback is on, returns name of the key that is used to return the printing system online.
PJI File System Commands	FSDELETE	Deletes printing system mass storage files.
	FSDOWNLOAD	Downloads files to the printing system mass storage system.
	FSINIT	Initializes the printing system mass storage file system.
	FSMKDIR	Creates a directory on the printing system mass storage file system.

## PJI command syntax

A PJI command line containing the ENTER command appears as follows:

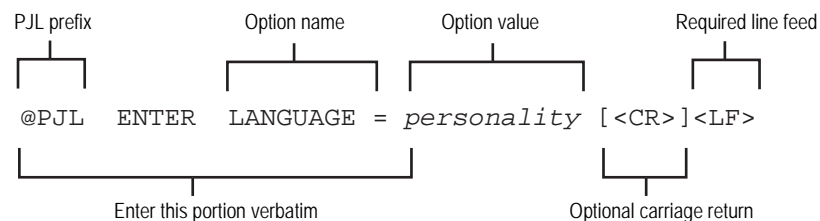

PJI syntax also uses the following control codes and special identifiers.

<HT>	Horizontal tab character (ASCII 9)
<LF>	Line feed character (ASCII 10)
<CR>	Carriage return character (ASCII 13)
<SP>	Space character (ASCII 32)
<ESC>	Escape character (ASCII 27)
<FF>	Form feed character (ASCII 12)
<WS>	White space, a result of one of more <SP> or <HT>.

- <words> Printable characters (ASCII characters 33 through 255) and <WS>, starting with a printable character.
- ^D KPDL end-of-file indication. It is not part of PJJ, but is used to end KPDL instructions.

The PJJ command syntax should follow one of four formats:

*Format 1:*

```
<ESC>%-12345X
```

This format uses the Universal Exit Language (UEL) only.

*Format 2:*

```
@PJJ [ <CR> ] <LF>
```

This format may be used to add a visual line break among the PJJ command lines.

*Format 3:*

```
@PJJ command [ <words> ] [ <CR> ] <LF>
```

This format is currently used for the COMMENT and ECHO commands only. For examples:

```
@PJJ COMMENT ... <LF>
@PJJ ECHO ... <LF>
```

*Format 4:*

```
@PJJ command [ command modifier : value ] [ option name
[ =value ] ] [ <CR> ] <LF>
```

This format is used comprehensively for all of the other PJJ commands.

```
@PJJ DEFAULT LPARM : PCL PTSIZE=14.25<LF>
```

## *Rules for PJJ Command Syntax*

This section provides the rules that should be observed in using PJJ commands:

- The prefix @PJJ always must be uppercase. Other parts of the PJJ command are not case-sensitive.
- Spacing between characters (white space) should either be the space character (ASCII 32) or the horizontal tab character (ASCII 9).

The placement of white space in PJJ commands depends on its location within the command. Some white space is mandatory and some is optional:

- White space is required between the @PJJ prefix and the PJJ command name, and between the PJJ command name and command modifiers. For example:

```
@PJJ OPMSG DISPLAY or
@PJJ ENTER LANGUAGE = personality
```

- If white space does not appear in any other place in the command, white space is optional.
- If white space appears between two portions of a PJJ command, it is not allowed. An example of white space use appears between the optional carriage return and required line feed character that terminate most commands.

## *PJL variables*

PJL uses alphanumeric variables, numeric variables, and strings. The following explains the three types of variables and their ranges.

### **Alphanumeric variables**

Any combination of letters and digits, with the rule that the first character must always be a letter. Letters can consist of the uppercase letters (ASCII 65 through 90) and lowercase letters (ASCII 97 through 122). Digits can consist of numbers 0 through 9 (ASCII 48 through 57).

Example of valid alphanumeric variables:

```
Alpha 635  
X2000
```

Examples of invalid alphanumeric variables:

```
635Alpha  
(Alphanumeric variables must begin with a letter)  
X 2000  
(Space characters [ASCII 32] are not allowed in alphanumeric variables)
```

### **Numeric variables**

Any number consisting of digits, with one optional decimal point and an optional plus (+) or minus (-) sign preceding the first digit. Only one decimal point may be used. It must also be placed somewhere after the first digit. Digits are unnecessary after the decimal point.

Examples of valid numeric variables:

```
0.123456  
-123.456  
+657000  
2468.
```

Examples of invalid numeric variables:

```
.123456  
(The decimal point must be preceded by at least 1 digit).  
-123.45.6  
(Only 1 decimal point is allowed in a numeric variable).  
+657,000  
(Commas should not be used in numeric variables).
```

### **Strings**

Strings should be enclosed in quotation marks, and consist of any combination of characters of ASCII codes from 32 through 255 including 9 (horizontal tab) but excluding 34 (quotation marks). Examples are as follows.

Examples of valid strings:

```
"Model:<HT>FS-9500DN" — Tabs are allowed in a string.  
"The Arlington Ball Park"
```

Examples of invalid strings:

```
"It is 3.5" long." — A string should not contain quotation marks.  
"Telephone number<CR>01234-5678"  
— <CR> is out of the valid range of ASCII characters for a string.
```



## Invalid Commands

Invalid commands are in two general types: those with syntax errors and those with syntax or semantic warnings. The printing system handles each of those types different ways.

Syntax errors contain errors such as unrecognized commands and command modifiers, strings with missing closing double quotations, numeric values with missing digits before the decimal points, and numeric values encountered when alphanumeric values are to be expected. The printing system ignores the entire PJI commands when it receives commands having syntax errors. Some examples follow.

The JOB command's NAME option requires double quotations around its value part.

Valid command:

```
@PJI JOB NAME = "Job Number 50" <LF>
```

Invalid command:

```
@PJI JOB NAME = "Job Number 51 <LF>
```

The closing quotation is required.

Syntax warnings and semantic warnings are issued for such commands that have unsupported options, values out of range, values missing or of the incorrect type, or values added when none are allowed. When the printing system receives commands with syntax or semantic warnings, the part of the command including the warning is ignored.

In the following example, the START option is valid for the JOB command.

Valid command:

```
@PJI JOB START = 1 <LF>
```

While in the following, FINISH is not a valid option and ignored (END should be used).

Invalid command:

```
@PJI JOB START = 1 FINISH = HOME <LF>
```

## PJI Reset Status

The following table shows the PJI and equivalent FRPO commands that initialize the environments.

*Table 7.24. PJI Reset Status*

Environment	PJI command	FRPO parameter
Printing resolution	RESOLUTION	—
Raster memory (HP Page protection)	PAGEPROTECT	FRPO R5
Personality	PERSONALITY	—
KIR (HP RET)	RET	FRPO N0
Interface timeout	TIMEOUT	FRPO N9
Copy	COPIES	FRPO C0
Paper size	PAPER	FRPO R2
Orientation	ORIENTATION	FRPO C1
Manual feed	MANUAL FEED	FRPO R4
Paper source	MANUAL FEED	FRPO R4
Output stack	OUTBIN	FRPO R0

*Table 7.24. PJI Reset Status*

Environment	PJI command	FRPO parameter
Duplex	DUPLEX	FRPO N4
Default font	FONTNUMBER	FRPO V3
Point size	PTSIZE	FRPO V0-2
Pitch	PITCH	—
Symbol set	SYMSET	FRPO U6/U7

# HP LaserJet Printer Commands — PCL

In the tables below, *Yes* means that the command is supported and *No* means that the command is not supported.

Table 7.25. HP LaserJet PCL Commands (Sheet 1 of 15)

Function	Parameter	Command	Hexadecimal Value	1000 1000+	1800 1900 3800	6300 6750 6900	9100DN 9500DN	8000C
<b>JOB CONTROL COMMANDS</b>								
<b>Reset</b>								
Reset		ESCE	1B 45	Yes	Yes	Yes	Yes	Yes
Number of Copies	# of Copies (1-999)	ESC&#X	1B 26 6C #...# 58	Yes	Yes	Yes	Yes	Yes
Long-Edge (Left) Offset	# of Decipoints (1/720")	ESC&#U	1B 26 6C #...# 55	Yes	Yes	Yes	Yes	Yes
Short-Edge (Top) Offset	# of Decipoints (1/720")	ESC&#Z	1B 26 6C #...# 5A	Yes	Yes	Yes	Yes	Yes
Unit of Measure	# = Number of units per inch	ESC&#D	1B 26 75 #...#44	Yes	Yes	Yes	Yes	Yes
Exit PCL Language	—	ESC%-12345X	1B 25 2D 31 32 33 34 35 58	Yes	Yes	Yes	Yes	Yes
<b>Simplex/Duplex Operation</b>								
Simplex/Duplex Print	Simplex	ESC&/0S	1B 26 6C 30 53	No	Yes	Yes	Yes	Yes
	Duplex Long-Edge-Binding	ESC&/1S	1B 26 6C 32 53	No	Yes	Yes	Yes	Yes
		ESC&/2S	1B 26 6C 32 53	No	Yes	Yes	Yes	Yes
Page Side Selection	Next side	ESC&a0G	1B 26 61 30 47	No	Yes	Yes	Yes	Yes
	Front Side	ESC&a1G	1B 26 61 31 47	No	Yes	Yes	Yes	Yes
	Back Side	ESC&a2G	1B 26 61 32 47	No	Yes	Yes	Yes	Yes
Job Separation	—	ESC&/IT	1B 26 6C 31 54	No	No	No	Yes	No
<b>PAGE CONTROL COMMANDS</b>								
<b>Page Length and Size</b>								
Paper Source	Current Tray (0)	ESC&/0H	1B 26 6C 30 48	Yes	Yes	Yes	Yes	Yes
	Upper Paper Tray (1)	ESC&/1H	1B 26 6C 31 48	Yes	Yes	Yes	Yes	Yes
	Manual Feeder (2)	ESC&/2H	1B 26 6C 32 48	Yes	Yes	Yes	Yes	Yes
	Manual Feeder (3)	ESC&/3H	1B 26 6C 33 48	Yes	Yes	Yes	Yes	Yes
	Lower (1) Tray (4)	ESC&/4H	1B 26 6C 34 48	Yes	Yes	Yes	Yes	Yes
	Lower (2) Tray (5)	ESC&/5H	1B 26 6C 35 48	No	Yes	Yes	Yes	No
	Envelope Tray (6)	ESC&/6H	1B 26 6C 36 48	No	Yes	Yes	Yes	No
	Auto Select (Media Type)	ESC&/7H	1B 26 6C 37 48	No	Yes	Yes	Yes	Yes
	3rd Tray in PF-60/4th Tray in PF-30	ESC&/20H	1B 26 6C 32 30 48	No	Yes	No	Yes	No
	5th Tray in PF-30	ESC&/21H	1B 26 6C 32 31 48	No	No	No	Yes	No
	6th Tray in PF-30	ESC&/22H	1B 26 6C 32 32 48	No	No	No	Yes	No

Table 7.25. HP LaserJet PCL Commands (Sheet 2 of 15)

Function	Parameter	Command	Hexadecimal Value	1000 1000+	1800 1900 3800	6300 6750 6900	9100DN 9500DN	8000C
Output Bin	Destination Tray 1 (Face down)	ESC&/1G	1B 25 6C 31 47	Yes	Yes	Yes	Yes	Yes
	Destination Tray 2 (Face up)	ESC&/2G	1B 25 6C 32 47	No	Yes	Yes	Yes	Yes
	Destination Tray 3 (Opt. Face down)	ESC&/3G	1B 26 6C 33 47	No	No	No	Yes	No
	Destination Tray 1 (Face down)	ESC&/4G	1B 26 6C 34 47	No	No	No	Yes	No
	Destination Tray 2 (Face down)	ESC&/5G	1B 26 6C 35 47	No	No	No	Yes	No
	Destination Tray 3 (Face down)	ESC&/6G	1B 26 6C 36 47	No	No	No	Yes	No
	Destination Tray 4 (Face down)	ESC&/7G	1B 26 6C 37 47	No	No	No	Yes	No
	Destination Tray 5 (Face down)	ESC&/8G	1B 26 6C 38 47	No	No	No	Yes	No
	Destination Tray 6 (Face down)	ESC&/9G	1B 26 6C 39 47	No	No	No	Yes	No
	Destination Tray 7 (Face down)	ESC&/10G	1B 26 6C 31 30 47	No	No	No	Yes	No
	Destination Tray 8 (Face down)	ESC&/11G	1B 26 6C 31 31 47	No	No	No	Yes	No
	Destination Tray 9 (Face down)	ESC&/12G	1B 26 6C 31 32 47	No	No	No	Yes	No
<b>Media Type</b>								
Media Type	Automatic <sup>a</sup>	ESC&n5Wd↵ Auto	35 57 64 61 75 74 6F	Yes	Yes	Yes	Yes	Yes
	Plain	ESC&n6Wd↵ Plain	36 57 64 50 6C 61 69 6E	Yes	Yes	Yes	Yes	Yes
	Transparency	ESC&n13Wd↵ Transparency	31 33 57 64 54 72 61 6E 73 70 61 72 65 6E 63 79	Yes	Yes	Yes	Yes	Yes
	Preprinted	ESC&n11Wd↵ Preprinted	31 31 57 64 50 72 65 70 72 69 6E 74 65 64	Yes	Yes	Yes	Yes	Yes
	Labels	ESC&n7Wd↵ Labels	37 57 64 4C 61 62 65 6C 73	Yes	Yes	Yes	Yes	Yes
	Bond	ESC&n5Wd↵ Bond	35 57 64 42 6F 6E 64	Yes	Yes	Yes	Yes	Yes
	Recycled	ESC&n9Wd↵ Recycled	39 57 64 52 65 63 79 63 6C 65 64	Yes	Yes	Yes	Yes	Yes
	Vellum	ESC&n7Vellum	37 56 65 6C 6C 75 6D 0D	Yes	Yes	Yes	Yes	Yes
	Rough	ESC&n6Wd↵ Rough		Yes	Yes	Yes	Yes	Yes
	Letterhead	ESC&n11Wd↵ Letterhead	31 31 57 64 4C 65 74 74 65 72 68 65 61 64	Yes	Yes	Yes	Yes	Yes

Table 7.25. HP LaserJet PCL Commands (Sheet 3 of 15)

Function	Parameter	Command	Hexadecimal Value	1000 1000+	1800 1900 3800	6300 6750 6900	9100DN 9500DN	8000C
Color		ESC&n6Wd← Color	36 57 64 43 6F 6C 6F 72	Yes	Yes	Yes	Yes	Yes
Prepunched		ESC&n11Wd← Prepunched	31 31 57 64 50 72 65 70 75 6E 63 68 65 64	Yes	Yes	Yes	Yes	Yes
Envelope		ESC&n9Wd← Envelope		Yes	Yes	Yes	Yes	Yes
Card stock		ESC&n11Wd← Cardstock	31 30 57 64 43 61 72 64 73 74 6F 63 6B	Yes	Yes	Yes	Yes	Yes
Custom 1		ESC&n8Wd← Custom1		Yes	Yes	Yes	Yes	Yes
Custom 2		ESC&n8Wd← Custom2		Yes	Yes	Yes	Yes	Yes
Custom 3		ESC&n8Wd← Custom3		Yes	Yes	Yes	Yes	Yes
Custom 4		ESC&n8Wd← Custom4		Yes	Yes	Yes	Yes	Yes
Custom 5		ESC&n8Wd← Custom5		Yes	Yes	Yes	Yes	Yes
Custom 6		ESC&n8Wd← Custom6		Yes	Yes	Yes	Yes	Yes
Custom 7		ESC&n8Wd← Custom7		Yes	Yes	Yes	Yes	Yes
Custom 8		ESC&n8Wd← Custom8		Yes	Yes	Yes	Yes	Yes
Page Size	Executive	ESC&i1A	1B 26 6C 31 41	Yes	Yes	Yes	Yes	Yes
	Letter	ESC&i2A	1B 26 6C 32 41	Yes	Yes	Yes	Yes	Yes
	Legal	ESC&i3A	1B 26 6C 33 41	Yes	Yes	Yes	Yes	Yes
	Ledger	ESC&i6A	1B 26 6C 36 41	No	No	Yes	Yes	No
	A5	ESC&i25A	1B 26 6C 32 35 41	Yes	Yes	Yes	Yes	No
	A4	ESC&i26A	1B 26 6C 32 36 41	Yes	Yes	Yes	Yes	Yes
	A3	ESC&i27A	1B 26 6C 32 37 41	No	No	Yes	Yes	No
	JIS B5	ESC&i45A	1B 26 6C 34 35 41	Yes	Yes	Yes	Yes	Yes
	JIS B4	ESC&i46A	1B 26 6C 34 36 41	No	No	Yes	Yes	No
	Hagaki	ESC&i71A	1B 26 6C 37 31 41	Yes	Yes	Yes	Yes	Yes
	Oufuku- Hagaki	ESC&i72A	1B 26 6C 37 32 41	Yes	Yes	Yes	Yes	Yes
	YOUKEI 2	ESC&i78A	1B 26 6C 37 38 41	No	No	No	Yes	No
	YOUKEI 4	ESC&i79A	1B 26 6C 37 39 41	No	No	No	Yes	No
	FOLIO	ESC&i77A	1B 26 6C 37 37 41	No	No	No	Yes	No
	STATEMENT	ESC&i76A	1B 26 6C 37 36 41	No	No	No	Yes	No
	OFICIO II	ESC&i73A	1B 26 6C 37 33 41	No	No	No	Yes	No

Table 7.25. HP LaserJet PCL Commands (Sheet 4 of 15)

Function	Parameter	Command	Hexadecimal Value	1000 1000+	1800 1900 3800	6300 6750 6900	9100DN 9500DN	8000C	
	International B5	ESC&/100A	1B 26 6C 31 30 30 41	Yes	Yes	Yes	Yes	Yes	
	Custom	ESC&/101A	1B 26 6C 31 30 31 41	Yes	Yes	Yes	Yes	No	
	Monarch	ESC&/80A	1B 26 6C 38 30 41	Yes	Yes	Yes	Yes	Yes	
	COM 10	ESC&/81A	1B 26 6C 38 31 41	Yes	Yes	Yes	Yes	Yes	
	DL	ESC&/90A	1B 26 6C 39 30 41	Yes	Yes	Yes	Yes	Yes	
	International C5	ESC&/91A	1B 26 6C 39 31 41	Yes	Yes	Yes	Yes	Yes	
Page Length	# of Lines	ESC&/#P	1B 26 6C #...# 050	Yes	Yes	Yes	Yes	Yes	
<b>Orientation</b>									
Orientation	Portrait	ESC&/00	1B 26 6C 30 4F	Yes	Yes	Yes	Yes	Yes	
	Landscape	ESC&/10	1B 26 6C 31 4F	Yes	Yes	Yes	Yes	Yes	
	Reverse Portrait	ESC&/20	1B 26 6C 32 4F	Yes	Yes	Yes	Yes	Yes	
	Reverse Landscape	ESC&/30	1B 26 6C 33 4F	Yes	Yes	Yes	Yes	Yes	
Print Direction	Degrees of Rotation (counterclockwise 90° increments only)	ESC&a#P	1B 26 61 #...#50	Yes	Yes	Yes	Yes	Yes	
Character Text Path Direction	Horizontal	ESC&c0T	1B 26 63 30 54	Yes	Yes	Yes	Yes	Yes	
	Vertical Rotated	ESC&c-1T	1B 26 63 2D 31 54	Yes	Yes	Yes	Yes	Yes	
<b>Margins and Text Length</b>									
Top Margin	# of Lines	ESC&/#E	1B 26 6C #...# 45	Yes	Yes	Yes	Yes	Yes	
Text Length	# of Lines	ESC&/#F	1B 26 6C #...# 46	Yes	Yes	Yes	Yes	Yes	
Left Margin	# of Columns	ESC&a#L	1B 26 61 #...# 4C	Yes	Yes	Yes	Yes	Yes	
Right Margin	# of Columns	ESC&a#M	1B 26 61 #...# 4D	Yes	Yes	Yes	Yes	Yes	
Clear Horizontal Margins		ESC9	1B 39	Yes	Yes	Yes	Yes	Yes	
<b>Perforation Skip Mode</b>									
Perforation Skip	Disable	ESC&/0L	1B 26 6C 30 4C	Yes	Yes	Yes	Yes	Yes	
	Enable	ESC&/1L	1B 26 6C 31 4C	Yes	Yes	Yes	Yes	Yes	
<b>Horizontal Column Spacing</b>									
Horizontal Motion Index (HMI)	# of 1/120" Increments	ESC&/k#H	1B 26 6B #...# 48	Yes	Yes	Yes	Yes	Yes	
<b>Vertical Line Spacing</b>									
Vertical Motion Index (VMI)	# of 1/48" Increments	ESC&/#C	1B 26 6C #...# 43	Yes	Yes	Yes	Yes	Yes	
Line Spacing (Lines per inch)	1 line/inch	ESC&/1D	1B 26 6C 31 44	Yes	Yes	Yes	Yes	Yes	
	2 lines/inch	ESC&/2D	1B 26 6C 32 44	Yes	Yes	Yes	Yes	Yes	
	3 lines/inch	ESC&/3D	1B 26 6C 33 44	Yes	Yes	Yes	Yes	Yes	
	4 lines/inch	ESC&/4D	1B 26 6C 34 44	Yes	Yes	Yes	Yes	Yes	
	6 lines/inch	ESC&/6D	1B 26 6C 36 44	Yes	Yes	Yes	Yes	Yes	
	8 lines/inch	ESC&/8D	1B 26 6C 38 44	Yes	Yes	Yes	Yes	Yes	
	12 lines/inch	ESC&/12D	1B 26 6C 31 32 44	Yes	Yes	Yes	Yes	Yes	

Table 7.25. HP LaserJet PCL Commands (Sheet 5 of 15)

Function	Parameter	Command	Hexadecimal Value	1000 1000+	1800 1900 3800	6300 6750 6900	9100DN 9500DN	8000C
	16 lines/inch	ESC&/16D	1B 26 6C 31 36 44	Yes	Yes	Yes	Yes	Yes
	24 lines/inch	ESC&/24D	1B 26 6C 32 34 44	Yes	Yes	Yes	Yes	Yes
	48 lines/inch	ESC&/48D	1B 26 6C 34 38 44	Yes	Yes	Yes	Yes	Yes
Alphanumeric ID	# of bytes	ESC&n#W [operation] [String]	1B 26 6E #...# 57	Yes	Yes	Yes	Yes	Yes
<b>CURSOR POSITIONING</b>								
<b>Vertical and Horizontal</b>								
Vertical Position	# of Rows	ESC&a#R	1B 26 61 #...# 52	Yes	Yes	Yes	Yes	Yes
	# of Dots	ESC*p#Y	1B 2A 70 #...# 59	Yes	Yes	Yes	Yes	Yes
	# of Decipoints	ESC&a#V	1B 26 61 #...# 56	Yes	Yes	Yes	Yes	Yes
Horizontal Position	# of Columns	ESC&a#C	1B 26 61 #...# 43	Yes	Yes	Yes	Yes	Yes
	# of Dots	ESC*p#X	1B 2A 70 #...# 58	Yes	Yes	Yes	Yes	Yes
	# of Decipoints	ESC&a#H	1B 26 61 #...# 48	Yes	Yes	Yes	Yes	Yes
Half Line Feed		ESC=	1B 3D	Yes	Yes	Yes	Yes	Yes
<b>End-of-Line Termination</b>								
Line Termination	CR = CR; LF = LF; FF = FF;	ESC&k0G	1B 26 6B 30 47	Yes	Yes	Yes	Yes	Yes
	CR = CR + LF LF = LF FF = FF	ESC&k1G	1B 26 6B 31 47	Yes	Yes	Yes	Yes	Yes
	CR = CR; LF = CR + LF; FF = CR + FF	ESC&k2G	1B 26 6B 32 47	Yes	Yes	Yes	Yes	Yes
	CR = CR + LF; LF = CR + LF; FF = CR + FF	ESC&k3G	1B 26 6B 33 47	Yes	Yes	Yes	Yes	Yes
<b>Push/Pop Position</b>								
Push/Pop Position	Push	ESC&f#S	1B 26 66 30 53	Yes	Yes	Yes	Yes	Yes
	Pop	ESC&f#S	1B 26 66 31 53	Yes	Yes	Yes	Yes	Yes
<b>FONT SELECTION</b>								
<b>Symbol Set Selection</b>								
Primary Symbol Set	ISO 60: Norwegian	ESC(0D)	1B 28 30 44	Yes	Yes	Yes	Yes	Yes
	ISO 4; United Kingdom	ESC(1E)	1B 28 31 45	Yes	Yes	Yes	Yes	Yes
	Windows 3.1 Latin 2	ESC(9E)	1B 28 39 45	Yes	Yes	Yes	Yes	Yes
	ISO 69: French	ESC(1F)	1B 28 31 46	Yes	Yes	Yes	Yes	Yes
	ISO 21: German	ESC(1G)	1B 28 31 47	Yes	Yes	Yes	Yes	Yes
	ISO 15: Italian	ESC(0I)	1B 28 30 49	Yes	Yes	Yes	Yes	Yes
	Microsoft publishing	ESC(6J)	1B 28 36 4A	Yes	Yes	Yes	Yes	Yes
	DeskTop	ESC(7J)	1B 28 37 4A	Yes	Yes	Yes	Yes	Yes
	PC1004	ESC(9J)	1B 28 39 4A	No	No	No	Yes	No
	PS Text	ESC(10J)	1B 28 31 30 4A	Yes	Yes	Yes	Yes	Yes
	MC Text	ESC(12J)	1B 28 31 32 4A	Yes	Yes	Yes	Yes	Yes
	Wingdings	ESC(579L 4C	1B 28 35 37 39 4C	No	Yes	Yes	Yes	Yes
PS Math	ESC(5M)	1B 28 35 4D	Yes	Yes	Yes	Yes	Yes	

Table 7.25. HP LaserJet PCL Commands (Sheet 6 of 15)

Function	Parameter	Command	Hexadecimal Value	1000 1000+	1800 1900 3800	6300 6750 6900	9100DN 9500DN	8000C
Math-8		ESC(8M	1B 28 38 4D	Yes	Yes	Yes	Yes	Yes
Symbol		ESC(19M	1B 28 31 39 4D	No	Yes	Yes	Yes	Yes
ECMA-94 Latin 1		ESC(0N	1B 28 30 4E	Yes	Yes	Yes	Yes	Yes
ISO L2		ESC(2N	1B 28 32 4E	Yes	Yes	Yes	Yes	Yes
ISO L5		ESC(5N	1B 28 35 4E	Yes	Yes	Yes	Yes	Yes
ISO 8859-10 Latin 6		ESC(6N	1B 28 36 4E	No	No	No	Yes	No
ISO 11: Swedish		ESC(0S	1B 28 30 53	Yes	Yes	Yes	Yes	Yes
ISO 17: Spanish		ESC(2S	1B 28 32 53	Yes	Yes	Yes	Yes	Yes
Windows 3.1 Latin 5		ESC(5T	1B 28 35 54	Yes	Yes	Yes	Yes	Yes
PC Turkish		ESC(9T	1B 28 39 54	Yes	Yes	Yes	Yes	Yes
ISO 6: ASCII		ESC(0U	1B 28 30 55	Yes	Yes	Yes	Yes	Yes
Legal		ESC(1U	1B 28 31 55	Yes	Yes	Yes	Yes	Yes
Roman-8		ESC(8U	1B 28 38 55	Yes	Yes	Yes	Yes	Yes
Windows 3.0 Latin 1		ESC(9U	1B 28 39 55	Yes	Yes	Yes	Yes	Yes
PC-8		ESC(10U	1B 28 31 30 55	Yes	Yes	Yes	Yes	Yes
PC-8 D/N		ESC(11U	1B 28 31 31 55	Yes	Yes	Yes	Yes	Yes
PC 850		ESC(12U	1B 28 31 32 55	Yes	Yes	Yes	Yes	Yes
Pi Font		ESC(15U	1B 28 31 35 55	Yes	Yes	Yes	Yes	Yes
PC-852		ESC(17U	1B 28 31 37 55	Yes	Yes	Yes	Yes	Yes
Windows 3.1 Latin 1 (ANSI)		ESC(19U	1B 28 31 39 55	Yes	Yes	Yes	Yes	Yes
PC-775		ESC(26U	1B 28 32 36 55	No	No	No	Yes	No
Windows 3.1J (Japanese)		ESC(19K	1B 28 31 39 4B	Yes	Yes	Yes	Yes	Yes
<b>Spacing</b>								
Primary Spacing	Fixed	ESC(s0P	1B 28 73 30 50	Yes	Yes	Yes	Yes	Yes
	Proportional	ESC(s1p	1B 28 73 31 50	Yes	Yes	Yes	Yes	Yes
<b>Pitch</b>								
Primary Pitch	# Characters/ inch	ESC(s#H	1B 28 73 #...#48	Yes	Yes	Yes	Yes	Yes
Set Pitch Mode	10.0	ESC&k0S	1B 26 6B 30 53	Yes	Yes	Yes	Yes	Yes
	Compressed (16.5-16.7)	ESC&k2S	1B 26 6B 32 53	Yes	Yes	Yes	Yes	Yes
	Elite (12.0)	ESC&k4S	1B 26 6B 34 53	Yes	Yes	Yes	Yes	Yes
<b>Point Size</b>								
Primary Height	# Points	ESC(s#V	1B 28 73 #...#56	Yes	Yes	Yes	Yes	Yes
<b>Style</b>								
Primary Style	Upright (Solid)	ESC(s0S	1B 28 73 30 53	Yes	Yes	Yes	Yes	Yes
	Italic	ESC(s1S	1B 28 73 31 53	Yes	Yes	Yes	Yes	Yes
	Condensed	ESC(s4S	1B 28 73 34 53	Yes	Yes	Yes	Yes	Yes
	Condensed Italic	ESC(s5S	1B 28 73 35 53	Yes	Yes	Yes	Yes	Yes
	Compressed (Extra Condensed)	ESC(s8S	1B 28 73 38 53	Yes	Yes	Yes	Yes	Yes
	Expanded	ESC(s24S	1B 28 73 32 34 53	Yes	Yes	Yes	Yes	Yes
	Outline	ESC(s32S	1B 28 73 33 32 53	Yes	Yes	Yes	Yes	Yes



Table 7.25. HP LaserJet PCL Commands (Sheet 7 of 15)

Function	Parameter	Command	Hexadecimal Value	1000 1000+	1800 1900 3800	6300 6750 6900	9100DN 9500DN	8000C	
	Inline	ESC(s64S	1B 28 73 36 34 53	Yes	Yes	Yes	Yes	Yes	
	Shadowed	ESC(s128S	1B 28 73 31 32 38 53	Yes	Yes	Yes	Yes	Yes	
	Outline Shadowed	ESC(s160S	1B 28 73 31 36 30 53	Yes	Yes	Yes	Yes	Yes	
<b>Stroke Weight</b>									
Primary Font Stroke Weight	Ultra Thin	ESC(s-7B	1B 28 73 2D 37 42	Yes	Yes	Yes	Yes	Yes	
	Extra Thin	ESC(s-6B	1B 28 73 2D 36 42	Yes	Yes	Yes	Yes	Yes	
	Thin	ESC(s-5B	1B 28 73 2D 35 42	Yes	Yes	Yes	Yes	Yes	
	Extra Light	ESC(s-4B	1B 28 73 2D 34 42	Yes	Yes	Yes	Yes	Yes	
	Light	ESC(s-3B	1B 28 73 2D 33 42	Yes	Yes	Yes	Yes	Yes	
	Demi Light	ESC(s-2B	1B 28 73 2D 32 42	Yes	Yes	Yes	Yes	Yes	
	Semi Light	ESC(s-1B	1B 28 73 2D 31 42	Yes	Yes	Yes	Yes	Yes	
	Medium (book or text)	ESC(s0B	1B 28 73 30 42	Yes	Yes	Yes	Yes	Yes	
	Semi Bold	ESC(s1B	1B 28 73 31 42	Yes	Yes	Yes	Yes	Yes	
	Demi Bold	ESC(s2B	1B 28 73 32 42	Yes	Yes	Yes	Yes	Yes	
	Bold	ESC(s3B	1B 28 73 33 42	Yes	Yes	Yes	Yes	Yes	
	Extra Bold	ESC(s4B	1B 28 73 34 42	Yes	Yes	Yes	Yes	Yes	
	Black	ESC(s5B	1B 28 73 35 42	Yes	Yes	Yes	Yes	Yes	
	Extra Black	ESC(s6B	1B 28 73 36 42	Yes	Yes	Yes	Yes	Yes	
Ultra Black	ESC(s7B	1B 28 73 37 42	Yes	Yes	Yes	Yes	Yes		
<b>Primary Typeface Family</b>									
Typeface Family	Albertus	ESC(s4362T	1B 28 73 34 31 36 32 54	Yes	Yes	Yes	Yes	Yes	
	Antique Olive	ESC(s4168T	1B 28 73 34 31 36 38 54	Yes	Yes	Yes	Yes	Yes	
	Clarendon	ESC(s4140T	1B 28 73 34 31 34 30 54	Yes	Yes	Yes	Yes	Yes	
	Coronet	ESC(s4116T	1B 28 73 34 31 31 36 54	Yes	Yes	Yes	Yes	Yes	
	Courier	ESC(s3T	1B 28 73 33 54	Yes	Yes	Yes	Yes	Yes	
	GW-Kai	ESC(s37357T	1B 28 73 33 37 33 35 37 54	Yes	Yes	Yes	Yes	Yes	
	Courier	ESC(s4099T	1B 28 73 34 30 39 39 54	Yes	Yes	Yes	Yes	Yes	
	ITC Zapf Dingbats	ESC(s4141T	1B 28 73 34 31 34 31 54	Yes	Yes	Yes	Yes	Yes	
	Garamond Antiqua	ESC(s4197T	1B 28 73 34 31 39 37 54	Yes	Yes	Yes	Yes	Yes	
	Letter Gothic	ESC(s4102T	1B 28 73 34 31 30 32 54	Yes	Yes	Yes	Yes	Yes	
	LinePrinter	ESC(s0T	1B 28 73 30 54	Yes	Yes	Yes	Yes	Yes	
	Marigold	ESC(s4297T	1B 28 73 34 32 39 37 54	Yes	Yes	Yes	Yes	Yes	
	CG Omega	ESC(s4113T	1B 28 73 34 31 31 33 54	Yes	Yes	Yes	Yes	Yes	
	CG Times	ESC(s4101T	1B 28 73 34 31 30 31 54	Yes	Yes	Yes	Yes	Yes	
	Univers	ESC(s4148T	1B 28 73 34 31 34 38 54	Yes	Yes	Yes	Yes	Yes	
	Arial	ESC(s16602T	1B 28 73 31 36 36 30 32 54	Yes	Yes	Yes	Yes	Yes	

Table 7.25. HP LaserJet PCL Commands (Sheet 8 of 15)

Function	Parameter	Command	Hexadecimal Value	1000 1000+	1800 1900 3800	6300 6750 6900	9100DN 9500DN	8000C
	MS Mincho	ESC(s28752T	1B 28 73 32 38 37 35 32 54	Yes	Yes	Yes	Yes	Yes
	MS Gothic	ESC(s28825T	1B 28 73 32 38 38 32 35 54	Yes	Yes	Yes	Yes	Yes
	Times New Roman	ESC(s1690IT	1B 28 73 31 36 39 30	Yes	Yes	Yes	Yes	Yes
	SimHei	ESC(s37110T	1B 28 73 33 37 31 31 30 54	Yes	Yes	Yes	Yes	Yes
	SimSun	ESC(s37058T	1B 28 73 33 37 30 35 38 54	Yes	Yes	Yes	Yes	Yes
	Symbol	ESC(s16686T	1B 28 73 31 36 36 38 36 54	Yes	Yes	Yes	Yes	Yes
	Wingdings	ESC(s6826T	1B 28 73 36 38 32 36 54	Yes	Yes	Yes	Yes	Yes
	Wingdings	ESC(s31402T	1B 28 73 33 31 34 30 32 54	Yes	Yes	Yes	Yes	Yes
<b>Font Default</b>								
Font Default	Primary Font	ESC(3@	1B 28 33 40	Yes	Yes	Yes	Yes	Yes
	Secondary Font	ESC)3@	1B 29 33 40	Yes	Yes	Yes	Yes	Yes
<b>Underline</b>								
Underline	Enable Fixed	ESC&d0D	1B 26 64 30 44	Yes	Yes	Yes	Yes	Yes
	Enable Floating	ESC&d3D	1B 26 64 33 44	Yes	Yes	Yes	Yes	Yes
	Disable	ESC&d@	1B 26 64 40	Yes	Yes	Yes	Yes	Yes
Text Parsing Method	1-Byte	ESC&t0P	1B 26 74 30 50	Yes	Yes	Yes	Yes	Yes
	1-Byte	ESC&t1P	1B 26 74 31 50	Yes	Yes	Yes	Yes	Yes
	1-Byte/2-Byte	ESC&t21P	1B 26 74 32 31 50	Yes	Yes	Yes	Yes	Yes
	1-Byte/2-Byte	ESC&t31P	1B 26 74 33 31 50	Yes	Yes	Yes	Yes	Yes
	1-Byte/2-Byte	ESC&t38P	1B 26 74 33 38 50	Yes	Yes	Yes	Yes	Yes
<b>Transparent Print</b>								
Transparent Print Data	# of Bytes	ESC&p#X↵ [Data]	1B 26 70 #...# 58	Yes	Yes	Yes	Yes	Yes
<b>FONT MANAGEMENT</b>								
Assign Font ID	Font ID #	ESC*c#D	1B 2A 63 #...# 44	Yes	Yes	Yes	Yes	Yes
Font and Character Control	Delete all Fonts	ESC*c0F	1B 2A 63 30 46	Yes	Yes	Yes	Yes	Yes
	Delete all temporary fonts	ESC*c1F	1B 2A 63 31 46	Yes	Yes	Yes	Yes	Yes
	Delete last font ID specified	ESC*c2F	1B 2A 63 32 46	Yes	Yes	Yes	Yes	Yes
	Delete last character specified	ESC*c3F	1B 2A 63 33 46	Yes	Yes	Yes	Yes	Yes
	Make font temporary	ESC*c4F	1B 2A 63 34 46	Yes	Yes	Yes	Yes	Yes
	Make font permanent	ESC*c5F	1B 2A 63 35 46	Yes	Yes	Yes	Yes	Yes
	Copy/Assign the currently invoked font as temporary	ESC*c6F	1B 2A 63 36 46	Yes	Yes	Yes	Yes	Yes
<b>Soft Symbol Set Management/Creation</b>								
Set Symbol Set	ID #	ESC*c#R	1B 2A 63 #...# 52	Yes	Yes	Yes	Yes	Yes

Table 7.25. HP LaserJet PCL Commands (Sheet 9 of 15)

Function	Parameter	Command	Hexadecimal Value	1000 1000+	1800 1900 3800	6300 6750 6900	9100DN 9500DN	8000C
DefineSymbol Set	# of Bytes	ESC(f#W[DATA]	1B 28 66#...#57	Yes	Yes	Yes	Yes	Yes
Symbol Set Control	Delete all symbol sets	ESC*c0S	1B 2A 63 30 53	Yes	Yes	Yes	Yes	Yes
	Delete all temporary symbol sets	ESC*c1S	1B 2A 63 31 53	Yes	Yes	Yes	Yes	Yes
	Delete current soft symbol set (last ID#)	ESC*c2S	1B 2A 63 32 53	Yes	Yes	Yes	Yes	Yes
	Make current soft symbol set temporary	ESC*c4S	1B 2A 63 34 53	Yes	Yes	Yes	Yes	Yes
	Make current soft symbol set permanent	ESC*c5S	1B 2A 63 35 53	Yes	Yes	Yes	Yes	Yes
<b>Font Selection by ID number</b>								
Select font (with ID #)	ID # primary font	ESC(#X	1B 28 #...# 58	Yes	Yes	Yes	Yes	Yes
	ID # secondary font	ESC)#X	1B 29 #...# 58	Yes	Yes	Yes	Yes	Yes
<b>Soft Font Creation</b>								
Font descriptor (font header)	# of bytes	ESC)s#W[Data]	1B 29 73#...#57	Yes	Yes	Yes	Yes	Yes
Download character	# of bytes	ESC(s#W[Data]	1B 28 73#...#57	Yes	Yes	Yes	Yes	Yes
Character code # (decimal)	Character code # (decimal)	ESC*c#E	1B 2A 63 #...# 45	Yes	Yes	Yes	Yes	Yes
<b>GRAPHICS</b>								
<b>PCL Vector Graphics Switching/Set-Up</b>								
Enter PCL Mode	Use previous PCL cursor position	ESC%0A	1B 25 30 41	Yes	Yes	Yes	Yes	Yes
	Use current HP-GL/2 pen position for cursor position	ESC%1A	1B 25 31 41	Yes	Yes	Yes	Yes	Yes
Enter HP-GL/2 Mode	Use Previous HP-GL/2 pen position	ESC%0B	1B 25 30 42	Yes	Yes	Yes	Yes	Yes
	Use current PCL cursor position	ESC%1B	1B 25 31 42	Yes	Yes	Yes	Yes	Yes
HP-GL/2 Plot Horizontal Size	Horizontal size in inches	ESC*c#K	1B 2A 63 #...# 48	Yes	Yes	Yes	Yes	Yes
HP-GL/2 Plot Vertical Size	Vertical size in inches	ESC*c#L	1B 2A 63 #...# 4C	Yes	Yes	Yes	Yes	Yes
Set Picture Frame Anchor Point	Set anchor point to cursor position	ESC*c0T	1B 2A 63 30 54	Yes	Yes	Yes	Yes	Yes
Picture Frame Horizontal Size	Decipoints	ESC*c#X	1B 2A 63 #...# 58	Yes	Yes	Yes	Yes	Yes
Picture Frame Vertical Size	Decipoints	ESC*c#Y	1B 2A 63 #...# 59	Yes	Yes	Yes	Yes	Yes

Table 7.25. HP LaserJet PCL Commands (Sheet 10 of 15)

Function	Parameter	Command	Hexadecimal Value	1000 1000+	1800 1900 3800	6300 6750 6900	9100DN 9500DN	8000C
<b>Raster Graphics</b>								
Raster Resolution	75 dots/inch	ESC*t75R	1B 2A 74 37 35 52	Yes	Yes	Yes	Yes	Yes
	100 dots/inch	ESC*t100R	1B 2A 74 31 30 30 52	Yes	Yes	Yes	Yes	Yes
	150 dots/inch	ESC*t150R	1B 2A 74 31 35 30 52	Yes	Yes	Yes	Yes	Yes
	200 dots/inch	ESC*t200R	1B 2A 74 32 30 30 52	No	Yes	No	Yes	Yes
	300 dots/inch	ESC*t300R	1B 2A 74 33 30 30 52	Yes	Yes	Yes	Yes	Yes
	600 dots/inch	ESC*t600R	1B 2A 74 36 30 30 52	No	Yes	No	Yes	Yes
<b>Orientation</b>								
<b>Raster Graphics</b>								
Raster Graphics Presentation	Follows orientation	ESC*r0F	1B 2A 72 30 46	Yes	Yes	Yes	Yes	Yes
	Follows physical page	ESC*r3F	1B 2A 72 33 46	Yes	Yes	Yes	Yes	Yes
Start Raster Graphics	Left Raster Graphics Margin	ESC*r0A	1B 2A 72 30 41	Yes	Yes	Yes	Yes	Yes
	Current Cursor	ESC*r1A	1B 2A 72 31 41	Yes	Yes	Yes	Yes	Yes
	Scale mode (logical left page boundary)	ESC*r2A	1B 2A 72 32 41	No	No	No	No	Yes
	Scale mode (at CAP)	ESC*r3A	1B 2A 72 33 42	No	No	No	No	Yes
Raster Y Offset	# of Raster Lines of vertical movement	ESC*b#Y	1B 2A 62 #...# 59	Yes	Yes	Yes	Yes	Yes
Set Raster Compression Mode	Unencoded	ESC*b0M	1B 2A 62 30 4D	Yes	Yes	Yes	Yes	Yes
	Run-Length Encoded	ESC*b1M	1B 2A 62 31 4D	Yes	Yes	Yes	Yes	Yes
	Tagged Image File Format	ESC*b2M	1B 2A 62 32 4D	Yes	Yes	Yes	Yes	Yes
	Delta Row	ESC*b3M	1B 2A 62 33 4D	Yes	Yes	Yes	Yes	Yes
	Adaptive compression	ESC*b5M	1B 2A 62 35 4D	Yes	Yes	Yes	Yes	Yes
	Replacement Delta Row	ESC*b9M	1B 2A 98 39 4D	Yes	Yes	Yes	Yes	Yes
Transfer Raster Data by row	# of Bytes	ESC*b#W [Data]	1B 2A 62 #...# 57	Yes	Yes	Yes	Yes	Yes
Transfer Raster Data (by plane)	# of Bytes	ESC*b#V [Data]	1B 2A 98 #...# 56	No	No	No	No	Yes
End Raster Graphics	Old version	ESC*rB	1B 2A 72 42	Yes	Yes	Yes	Yes	Yes
	Preferred	ESC*rC	1B 2A 72 43	Yes	Yes	Yes	Yes	Yes
Raster Height (Source)	# Raster Rows	ESC*r#T	1B 2A 72 #...# 54	Yes	Yes	Yes	Yes	Yes
Raster Width (Source)	# Pixels of the Specified Resolution	ESC*r#S	1B 2A 72 #...# 53	Yes	Yes	Yes	Yes	Yes
<b>THE PRINT MODEL</b>								
<b>Imaging</b>								

Table 7.25. HP LaserJet PCL Commands (Sheet 11 of 15)

Function	Parameter	Command	Hexadecimal Value	1000 1000+	1800 1900 3800	6300 6750 6900	9100DN 9500DN	8000C	
Select Current Pattern	Solid Black (default)	ESC*v0T	1B 2A 76 30 54	Yes	Yes	Yes	Yes	Yes	
	Solid White	ESC*v1T	1B 2A 76 31 54	Yes	Yes	Yes	Yes	Yes	
	HP-defined Shading Pattern	ESC*v2T	1B 2A 76 32 54	Yes	Yes	Yes	Yes	Yes	
	HP-defined Cross-Hatched Pattern	ESC*v3T	1B 2A 76 33 54	Yes	Yes	Yes	Yes	Yes	
	User defined pattern	ESC*v4T	1B 2A 76 34 54	Yes	Yes	Yes	Yes	Yes	
Source Transparency Mode	Transparent	ESC*v0N	1B 2A 76 30 4E	Yes	Yes	Yes	Yes	Yes	
	Opaque	ESC*v1N	1B 2A 76 31 4E	Yes	Yes	Yes	Yes	Yes	
Pattern Transparency Mode	Transparent	ESC*v0O	1B 2A 76 30 4F	Yes	Yes	Yes	Yes	Yes	
	Opaque	ESC*v1O	1B 2A 76 31 4F	Yes	Yes	Yes	Yes	Yes	
Logical Operation	# = ROP3 input value	ESC*#O	1B 2A 6C #...# 4F	Yes	Yes	Yes	Yes	Yes	
Pixel Placement	Grid Intersection	ESC*v0R	1B 2A 6C 30 52	Yes	Yes	Yes	Yes	Yes	
	Pixel Placement	ESC*v1R	1B 2A 76 31 52	Yes	Yes	Yes	Yes	Yes	
<b>Rectangle Dimensions</b>									
Rectangle Width (Horizontal Size)	# of dots	ESC*c#A	1B 2A 63 #...# 41	Yes	Yes	Yes	Yes	Yes	
	# of decipoints	ESC*c#H	1B 2A 63 #...# 48	Yes	Yes	Yes	Yes	Yes	
Rectangle Height (Vertical Size)	# of dots	ESC*c#B	1B 2A 63 #...# 42	Yes	Yes	Yes	Yes	Yes	
	# of decipoints	ESC*c#V	1B 2A 63 #...# 56	Yes	Yes	Yes	Yes	Yes	
<b>Rectangular Area Fill</b>									
Fill Rectangular Area	Solid Black	ESC*c0P	1B 2A 63 30 50	Yes	Yes	Yes	Yes	Yes	
	Erase (solid white fill)	ESC*c1P	1B 2A 63 31 50	Yes	Yes	Yes	Yes	Yes	
	Shaded Fill	ESC*c2P	1B 2A 63 32 50	Yes	Yes	Yes	Yes	Yes	
	Cross-hatched Fill	ESC*c3P	1B 2A 63 33 50	Yes	Yes	Yes	Yes	Yes	
	User-Defined	ESC*c4P	1B 2A 63 34 50	Yes	Yes	Yes	Yes	Yes	
	Current Pattern	ESC*c5P	1B 2A 63 35 50	Yes	Yes	Yes	Yes	Yes	
Pattern ID	% of Shading or Type of Pattern or User Pattern ID	ESC*c#G	1B 2A 63 #...# 47	Yes	Yes	Yes	Yes	Yes	
Shading	2% Gray	ESC*c2G	1B 2A 63 32 47	Yes	Yes	Yes	Yes	Yes	
	10% Gray	ESC*c10G	1B 2A 63 31 30 47	Yes	Yes	Yes	Yes	Yes	
	15% Gray	ESC*c15G	1B 2A 63 31 35 47	Yes	Yes	Yes	Yes	Yes	
	30% Gray	ESC*c30G	1B 2A 63 33 30 47	Yes	Yes	Yes	Yes	Yes	
	45% Gray	ESC*c45G	1B 2A 63 34 35 47	Yes	Yes	Yes	Yes	Yes	
	70% Gray	ESC*c70G	1B 2A 63 37 30 47	Yes	Yes	Yes	Yes	Yes	
	90% Gray	ESC*c90G	1B 2A 63 39 30 47	Yes	Yes	Yes	Yes	Yes	
	100% Gray	ESC*c100G	1B 2A 63 31 30 30 47	Yes	Yes	Yes	Yes	Yes	

Table 7.25. HP LaserJet PCL Commands (Sheet 12 of 15)

Function	Parameter	Command	Hexadecimal Value	1000 1000+	1800 1900 3800	6300 6750 6900	9100DN 9500DN	8000C
Pattern	1 Horiz.Line	ESC*c1G	1B 2A 63 31 47	Yes	Yes	Yes	Yes	Yes
	2 Vert. Lines	ESC*c2G	1B 2A 63 32 47	Yes	Yes	Yes	Yes	Yes
	3 Diagonal Lines	ESC*c3G	1B 2A 63 33 47	Yes	Yes	Yes	Yes	Yes
	4 Diagonal Lines	ESC*c4G	1B 2A 63 34 47	Yes	Yes	Yes	Yes	Yes
	5 Square Grid	ESC*c5G	1B 2A 63 35 47	Yes	Yes	Yes	Yes	Yes
	6 Diagonal Grid	ESC*c6G	1B 2A 63 36 47	Yes	Yes	Yes	Yes	Yes
<b>USER DEFINED PATTERN / MANAGEMENT CREATION</b>								
User-Defined Pattern Control	Delete all patterns	ESC*c0Q	1B 2A 63 030 51	Yes	Yes	Yes	Yes	Yes
	Delete all temporary patterns	ESC*c1Q	1B 2A 63 031 51	Yes	Yes	Yes	Yes	Yes
	Delete current pattern	ESC*c2Q	1B 2A 63 032 51	Yes	Yes	Yes	Yes	Yes
	Make pattern temporary	ESC*c4Q	1B 2A 63 034 51	Yes	Yes	Yes	Yes	Yes
	Make pattern permanent	ESC*c5Q	1B 2A 63 035 51	Yes	Yes	Yes	Yes	Yes
Set Pattern Reference Point	Rotate with orientation	ESC*p0R	1B 2A 70 30 52	Yes	Yes	Yes	Yes	Yes
	Follow physical page	ESC*p1R	1B 2A 70 31 52	Yes	Yes	Yes	Yes	Yes
<b>MACROS</b>								
Macro ID	Macro ID #	ESC&f#Y	1B 26 66 #...# 59	Yes	Yes	Yes	Yes	Yes
Macro Control	Start Macro Definition	ESC&f0X	1B 26 66 30 58	Yes	Yes	Yes	Yes	Yes
	Stop Macro Definition	ESC&f1X	1B 26 66 31 58	Yes	Yes	Yes	Yes	Yes
	Execute Macro	ESC&f2X	1B 26 66 32 58	Yes	Yes	Yes	Yes	Yes
	Call Macro	ESC&f3X	1B 26 66 33 58	Yes	Yes	Yes	Yes	Yes
	Enable Overlay	ESC&f4X	1B 26 66 34 58	Yes	Yes	Yes	Yes	Yes
	Disable Overlay	ESC&f5X	1B 26 66 35 58	Yes	Yes	Yes	Yes	Yes
	Delete Macros	ESC&f6X	1B 26 66 36 58	Yes	Yes	Yes	Yes	Yes
	Delete All Temp. Macros	ESC&f7X	1B 26 66 37 58	Yes	Yes	Yes	Yes	Yes
	Delete Macro ID	ESC&f8X	1B 26 66 38 58	Yes	Yes	Yes	Yes	Yes
	Make Temporary	ESC&f9X	1B 26 66 39 58	Yes	Yes	Yes	Yes	Yes
Make Permanent	ESC&f10X	1B 26 66 31 30 58	Yes	Yes	Yes	Yes	Yes	
<b>Set Status Readback</b>								
Status Readback Location Type	Invalid Location	ESC*s0T	1B 2A 73 30 54	Yes	Yes	Yes	Yes	Yes
	Currently Selected	ESC*s1T	1B 2A 73 31 54	Yes	Yes	Yes	Yes	Yes
	All Locations	ESC*s2T	1B 2A 73 32 54	Yes	Yes	Yes	Yes	Yes
	Internal	ESC*s3T	1B 2A 73 33 54	Yes	Yes	Yes	Yes	Yes
	Downloaded	ESC*s4T	1B 2A 73 34 54	Yes	Yes	Yes	Yes	Yes
	Cartridge	ESC*s5T	1B 2A 73 35 54	Yes	Yes	Yes	Yes	Yes
	User-installed ROM (SIMMs)	ESC*s7T	1B 2A 73 37 54	Yes	Yes	Yes	Yes	Yes

Table 7.25. HP LaserJet PCL Commands (Sheet 13 of 15)

Function	Parameter	Command	Hexadecimal Value	1000 1000+	1800 1900 3800	6300 6750 6900	9100DN 9500DN	8000C	
Set Status Readback Location Unit	All entities of the Location Type	ESC*s0U	1B 2A 73 30 55	Yes	Yes	Yes	Yes	Yes	
	Entity 1 or Temporary	ESC*s1U	1B 2A 73 31 55	Yes	Yes	Yes	Yes	Yes	
	Entity 2 or Permanent	ESC*s2U	1B 2A 73 32 55	Yes	Yes	Yes	Yes	Yes	
	Entity 3	ESC*s3U	1B 2A 73 33 55	Yes	Yes	Yes	Yes	Yes	
	Entity 4	ESC*s4U	1B 2A 73 34 55	Yes	Yes	Yes	Yes	Yes	
Inquire Status Readback Entity	Font	ESC*s0I	1B 2A 73 30 49	Yes	Yes	Yes	Yes	Yes	
	Macro	ESC*s1I	1B 2A 73 31 49	Yes	Yes	Yes	Yes	Yes	
	User-defined Pattern	ESC*s2I	1B 2A 73 32 49	Yes	Yes	Yes	Yes	Yes	
	Symbol Set	ESC*s3I	1B 2A 73 33 49	Yes	Yes	Yes	Yes	Yes	
	FontExtended	ESC*s4I	1B 2A 73 34 49	Yes	Yes	Yes	Yes	Yes	
Flush All Pages	Flush all complete pages	ESC&r0F	1B 26 72 30 46	Yes	Yes	Yes	Yes	Yes	
	Flush all page data	ESC&r1F	1B 26 72 31 46	Yes	Yes	Yes	Yes	Yes	
Free Memory Space	Request free memory status	ESC*s1M	1B 2A 73 31 4D	Yes	Yes	Yes	Yes	Yes	
Echo	# = Echo value (-32767 to 32767)	ESC*s#X	1B 2A 73 #...# 58	Yes	Yes	Yes	Yes	Yes	
<b>PROGRAMMING HINTS</b>									
End-of-Line Wrap	Enabled	ESC&s0C	1B 26 73 30 43	Yes	Yes	Yes	Yes	Yes	
	Disabled	ESC&s1C	1B 26 73 31 43	Yes	Yes	Yes	Yes	Yes	
Display Functions	ON	ESC Y	1B 59	Yes	Yes	Yes	Yes	Yes	
	OFF	ESC Z	1B 5A	Yes	Yes	Yes	Yes	Yes	
<b>PCL Vector Graphics Switching/Set-Up Picture Frame</b>									
Enter PCL Mode	Use previous PCL cursor position	ESC%0A	1B 25 30 41	Yes	Yes	Yes	Yes	Yes	
	Use current HP-GL/2 pen position for cursor position	ESC%1A	1B 25 31 41	Yes	Yes	Yes	Yes	Yes	
Enter HP- GL/2 Mode	Use Previous HP-GL/2 pen position	ESC%0B	1B 25 30 42	Yes	Yes	Yes	Yes	Yes	
	Use current PCL cursor position	ESC%1B	1B 25 31 42	Yes	Yes	Yes	Yes	Yes	
	Current PCL coordinate system/old HPGL pen position	ESC%2B	1B 25 32 42	Yes	Yes	Yes	Yes	Yes	
	Current PCL coordinate system/current PCL CAP	ESC%3B	1B 25 33 42	Yes	Yes	Yes	Yes	Yes	
HP-GL/2 Plot Horizontal Size	Horizontal size in inches	ESC*c#K	1B 2A 63 #...# 4B	Yes	Yes	Yes	Yes	Yes	
HP-GL/2 Plot Vertical Size	Vertical size in inches	ESC*c#L	1B 2A 63 #...# 4C	Yes	Yes	Yes	Yes	Yes	
Set Picture Frame Anchor Point	Set anchor point to cursor position	ESC*c0T	1B 2A 63 30 54	Yes	Yes	Yes	Yes	Yes	

Table 7.25. HP LaserJet PCL Commands (Sheet 14 of 15)

Function	Parameter	Command	Hexadecimal Value	1000 1000+	1800 1900 3800	6300 6750 6900	9100DN 9500DN	8000C
Picture Frame Horizontal Size	Decipoints	ESC*c#X	1B 2A 63 #...# 58	Yes	Yes	Yes	Yes	Yes
Picture Frame Vertical Size	Decipoints	ESC*c#Y	1B 2A 63 #...# 59	Yes	Yes	Yes	Yes	Yes
<b>Colors</b>								
Assign Color Index	Index Number	ESC*v#I	1B 2A 76 #...# 49	No	No	No	No	Yes
Color Component 1	1st Component	ESC*v#A	1B 2A 76 #...# 41	No	No	No	No	Yes
Color Component 2	2nd Component	ESC*v#B	1B 2A 76 #...# 42	No	No	No	No	Yes
Color Component 3	3rd Component	ESC*v#C	1B 2A 76 #...# 43	No	No	No	No	Yes
Color Lookup Tables	# of Bytes	ESC*l#W	1B 2A 6C #...# 57	No	No	No	No	Yes
Configure Image Data	# of Bytes	ESC*v#W	1B 2A 76 #...# 57	No	No	No	No	Yes
Download Dither Matrix	# of Bytes	ESC*m#W	1B 2A 76 #...# 49	No	No	No	No	Yes
Foreground Color	Index Number	ESC*v#S	1B 2A 76 #...# 53	No	No	No	No	Yes
Gamma Correction	Gamma number	ESC*t#I	1B 2A 74 #...# 49	No	No	No	No	Yes
Monochrome Print Model	Mixed Rendering	ESC&b#M	1B 26 98 30 4D	No	No	No	No	Yes
	Gray Equivalent	ESC&b#M	1B 26 98 31 4D	No	No	No	No	Yes
Palette Control ID	Palette ID #	ESC&p#I	1B 26 70 #...#49	No	No	No	No	Yes
Palette Control	Delete All Palettes in store	ESC&p#C	1B 26 70 30 43	No	No	No	No	Yes
	Delete All Palettes in stack	ESC*p#C	1B 26 70 31 43	No	No	No	No	Yes
	Delete Palette (last ID)	ESC*p#C	1B 26 70 32 43	No	No	No	No	Yes
	Copy Palette	ESC*p#C	1B 26 70 36 43	No	No	No	No	Yes
Push/Pop Palette	Push Palette	ESC*p#P	1B 2A 70 30 50	No	No	No	No	Yes
	Pop Palette	ESC*p#P	1B 2A 70 31 50	No	No	No	No	Yes
Render Algorithm	Continuous tone detail	ESC*t#J	1B 2A 74 30 4A	No	No	No	No	Yes
	Snap to primaries	ESC*t#J	1B 2A 74 31 4A	No	No	No	No	Yes
	Snap black/white, colors to black	ESC*t#J	1B 2A 74 32 4A	No	No	No	No	Yes
	Device best dither	ESC*t#J	1B 2A 74 33 4A	No	No	No	No	Yes
	Error diffusion	ESC*t#J	1B 2A 74 34 4A	No	No	No	No	Yes
	Monochrome device best dither	ESC*t#J	1B 2A 74 35 4A	No	No	No	No	Yes
	Monochrome error diffusion	ESC*t#J	1B 2A 74 36 4A	No	No	No	No	Yes
	Cluster ordered dither	ESC*t#J	1B 2A 74 37 4A	No	No	No	No	Yes
	Monochrome cluster ordered	ESC*t#J	1B 2A 74 38 4A	No	No	No	No	Yes



Table 7.25. HP LaserJet PCL Commands (Sheet 15 of 15)

Function	Parameter	Command	Hexadecimal Value	1000 1000+	1800 1900 3800	6300 6750 6900	9100DN 9500DN	8000C
	User-defined dither	ESC*t#J	1B 2A 74 30 4A	No	No	No	No	Yes
	Monochrome user-defined dither	ESC*t#J	1B 2A 74 31 30 4A	No	No	No	No	Yes
	Ordered dither	ESC*t#J	1B 2A 74 31 31 4A	No	No	No	No	Yes
	Monochrome ordered dither	ESC*t#J	1B 2A 74 31 32 4A	No	No	No	No	Yes
	Noise ordered dither	ESC*t#J	1B 2A 74 31 33 4A	No	No	No	No	Yes
	Monochrome noise ordered dither	ESC*t#J	1B 2A 74 31 34 4A	No	No	No	No	Yes
	Continuous tone smooth	ESC*t#J	1B 2A 74 31 35 4A	No	No	No	No	Yes
	Mono, continuous tone detail	ESC*t#J	1B 2A 74 31 36 4A	No	No	No	No	Yes
	Mono, continuous tone smooth	ESC*t#J	1B 2A 74 31 37 4A	No	No	No	No	Yes
	Continuous tone basic	ESC*t#J	1B 2A 74 31 38 4A	No	No	No	No	Yes
	Mono continuous tone basic	ESC*t#J	1B 2A 74 31 39 4A	No	No	No	No	Yes
Select Palette	Palette ID #	ESC&p#S	1B 26 70 #...# 53	No	No	No	No	Yes
Set Viewing Illuminant	# of Bytes	ESC*I#W	1B 2A 69 #...# 57	No	No	No	No	Yes
Simple Color	3-Plane Device CMY Palette	ESC*r#U	1B 2A 72 2D 33 55	No	No	No	No	Yes
	1-Plane K palette	ESC*r#U	1B 2A 72 31 55	No	No	No	No	Yes
	3-Plane Device RGB Palette	ESC*r#U	1B 2A 72 33 55	No	No	No	No	Yes
Transfer Raster (Plane)	# of Bytes	ESC*b#V	1B 2A 98 #...# 56	No	No	No	No	Yes

<sup>a</sup> Not supported by HP PCL.

## HP-GL/2 Context Printer Commands

In the command tables below, parameters in brackets are optional.

Table 7.26. HP-GL/2 Context Printer Commands (Sheet 1 of 2)

Command	Mnemonic	Parameters
<b>DUAL CONTEXT EXTENSIONS</b>		
ENTER PCL MODE	ESC%#A	0 = Retain previous PCL cursor position 1 = Use current HP-GL/2 pen position
RESET	ESC <sub>E</sub>	None
PRIMARY FONT	F1	Font_ID
SECONDARY FONT	FN	Font_ID
SCALABLE OR BITMAPPED FONTS	SB	0 = Scalable fonts only 1 = Bitmapped fonts allowed
<b>PALETTE EXTENSIONS</b>		
Color Range	CR	[b_ref_red, w_ref_red, b_ref_grn, w_ref_grn, b_ref_blue, w_ref_blue];
Number of Pens	NP	[n];
Pen Color Assignment	PC	[pen [.red, green, blue]];
TRANSPARENCY MODE	TR	0 = Off (opaque) 1 = On (transparent)
SCREENED VECTORS	SV	[screen_type[,shading[,index]]]
<b>VECTOR GROUP</b>		
ARC ABSOLUTE	AA	x_center,y_center,sweep_angle [,chord_angle];
ARC RELATIVE	AR	x_increment,y_increment,sweep_angle [,chord_angle];
ABSOLUTE ARC THREE POINT	AT	x_inter,y_inter,x_end,y_end [,chord_angle];
PLOT ABSOLUTE	PA	[x,y...[,x,y]];
PLOT RELATIVE	PR	[x,y...[,x,y]];
PEN DOWN	PD	[x,y...[,x,y]];
PEN UP	PU	[x,y...[,x,y]];
RELATIVE ARC THREE POINT	RT	x_incr_inter,y_incr_inter,x_incr_end, y_incr_end [,chord_angle];
POLYLINE ENCODED	PE	[flag[val]coord_pair...[flag[val]coord _pair];
<b>POLYGON GROUP</b>		
BEZIER RELATIVE	BR	kind, x1_control_pt_increments, y1_control_pt_increments, x2_control_pt_increments, y2_control_pt_increments, x3_control_pt_increments, y3_control_pt_increments, [,params ... [,params]];
CIRCLE	CI	radius [,chord_angle];
FILL RECTANGLE ABSOLUTE	RA	x_coordinate,y_coordinate;
FILL RECTANGLE RELATIVE	RR	x_increment,y_increment;
EDGE RECTANGLE ABSOLUTE	EA	x_coordinate,y_coordinate;
EDGE RECTANGLE RELATIVE	ER	x_increment,y_increment;
FILL WEDGE	WG	radius,start_angle, sweep_angle [,chord_angle];
EDGE WEDGE	EW	radius,start_angle, sweep_angle[,chord_angle];
POLYGON MODE	PM	polygon_definition;
FILL POLYGON	FP	
EDGE POLYGON	EP	
<b>CHARACTER GROUP</b>		
SELECT STANDARD FONT	SS	None

Table 7.26. HP-GL/2 Context Printer Commands (Sheet 2 of 2)

Command	Mnemonic	Parameters
SELECT ALTERNATE FONT	SA	None
ABSOLUTE DIRECTION	DI	[run,rise];
RELATIVE DIRECTION	DR	[run,rise];
ABSOLUTE CHARACTER SIZE	SI	[width,height];
RELATIVE CHARACTER SIZE	SR	[width,height];
CHARACTER SLANT	SL	[tangent_of_angle];
EXTRA SPACE	ES	[width[,height]]
STANDARD FONT DEFINITION	SD	[kind,value...[,kind,value]];
ALTERNATE FONT DEFINITION	AD	[kind,value...[,kind,value]];
CHARACTER FILL MODE	CF	[fill_mode[,edge_pen]];
LABEL ORIGIN	LO	[position];LABEL
LABEL	LB	[char...[,char]]bterm
DEFINE LABEL TERMINATOR	DT	[lterm[,mode]];
CHARACTER PLOT	CP	[spaces,lines];
TRANSPARENT DATA	TD	[mode];
DEFINE VARIABLE TEXT PATH	DV	[path[,line]];
<b>LINE AND FILL ATTRIBUTES GROUP</b>		
LINE TYPE	LT	[line_type[,pattern_length[,mode]]];
LINE ATTRIBUTES	LA	[kind,value...[,kind,value]];
PEN WIDTH	PW	[width[,pen]];
PEN WIDTH UNIT SELECTION	WU	[type];
SELECT PEN	SP	[pen]; (required, 1 for black or 0 for white)
SYMBOL MODE	SM	[char];
FILL TYPE	FT	[fill_type[,option1 [,option2]]];
ANCHOR CORNER	AC	[x_coordinate,y_coordinate];
RASTER FILL DEFINITION	RF	[index[,width,height,pen_nbr...pen_nbr]]; (width and height must be less than 255)
USER DEFINED LINE TYPE	UL	[index[,gap1...gapn]];
<b>CONFIGURATION AND STATUS GROUP</b>		
Advance Full Page	PG	[n];
SCALE	SC	[x1,x2,y1,y2[,type[,left,bottom]]]; or [x1,xfactor,y1,yfactor,2];
INPUT WINDOW	IW	[xLL,yLL,xUR,yUR];
INPUT P1 AND P2	IP	[p1x,p1y[,p2x,p2y]];
INPUT RELATIVE P1 AND P2	IR	[p1x,p1y[,p2x,p2y]];
DEFAULT VALUES	DF	
INITIALIZE	IN	[n];
Replot	RP	[n];
ROTATE COORDINATE SYSTEM	RO	[angle];
<b>TECHNICAL GRAPHICS EXTENSION</b>		
Begin Plot	BP	[kind,value...[,kind,value]];
Chord Tolerance Mode	CT	[mode];
Download Character	DL	[charnum [[,up], x, y...[,up],x,y]];
Frame Advance	FR	
Media Type	MT	[type];
Merge Control	MC	[mode [, opcod]];
Output Error	OE	
Output Hardclip Limits	OH	
Output Identification	OI	
Output P1 and P2	OP	
Output Status	OS	
Pixel Placement	PP	[mode];
Plot Size	PS	[length [,width]];
Quality Level	QL	[quality level]

## PJL Syntax Comparison

Table 7.27. PJL Syntax Comparison

Suggested Syntax Rules	
[ ]	Items in brackets “[ . . . ]” indicate optional parameters.
< >	Identifies a control code character
Special Identifiers	
<HT>	Horizontal tab character (ASCII 9).
<LF>	Line feed character (ASCII 10).
<CR>	Carriage return character (ASCII 13).
<SP>	Space character (ASCII 32).
<WS>	White space
<ESC>	Escape character (ASCII 27).
<FF>	Form feed character (ASCII 12).
<Words>	Printable characters (ASCII characters 33 through 126) and <WS>
PJL Commands	
COMMENT	@PJL COMMENT <Words> [<CR>] <LF>
DEFAULT	@PJL DEFAULT [LPARM: personality] variable = value [<CR>] <LF>
DINQUIRE	@PJL DINQUIRE [LPARM: personality] variable [<CR>] <LF>
Response	@PJL DINQUIRE [LPARM: personality] variable <CR> <LF> value <CR> <LF> <FF>
ECHO	@PJL ECHO [<Words>] [<CR>] <LF>
Response	@PJL ECHO [<Words>] <CR> <LF> <FF>
ENTER	@PJL ENTER LANGUAGE = personality [<CR>] <LF>
EOJ	@PJL EOJ [NAME = “job name”] [<CR>] <LF>
INFO	@PJL INFO read only variable [<CR>] <LF>
Response	@PJL INFO read only variable <CR> <LF> [1 or more lines of printable characters or <WS> followed by <CR> <LF>] <FF>
INITIALIZE	@PJL INITIALIZE [<CR>] <LF>
INQUIRE	@PJL INQUIRE [LPARM: personality] variable [<CR>] <LF>
Response	@PJL INQUIRE [LPARM: personality] variable <CR> <LF> value <CR> <LF> <FF>
JOB	@ PJL JOB [NAME = “job name”] [START
OPMSG	@PJL OPMSG DISPLAY = “message” [<CR>] <LF>,
RDYMSG	@PJL RDYMSG DISPLAY = “message” [<CR>] <LF>,
RESET	@PJL RESET [<CR>] <LF>
SET	@PJL SET [LPARM: personality] variable = value [<CR>] <LF>,
STMSG	@PJL STMSG DISPLAY = “message” [<CR>] <LF>,
Response	@PJL STMSG DISPLAY = “message” <CR> <LF>
UEL/SPJL	<ESC>%-12345X
USTATUS	@PJL USTATUS variable = value [<CR>] <LF>,
Response	@PJL USTATUS variable <CR> <LF> [1 or more lines of printable characters or <WS> followed by <CR> <LF>] <FF>,
USTATUSOFF	@PJL USTATUSOFF [<CR>] <LF>
PJL	@PJL [<CR>] <LF>

ISO-15 Italian (0I)

0	1	2	3	4	5	6	7	8	9	A	B	C	D	E	F
0	16	32	48	64	80	96	112	128	144	160	176	192	208	224	240
1	17	33	49	65	81	97	113	129	145	161	177	193	209	225	241
2	18	34	50	66	82	98	114	130	146	162	178	194	210	226	242
3	19	35	51	67	83	99	115	131	147	163	179	195	211	227	243
4	20	36	52	68	84	100	116	132	148	164	180	196	212	228	244
5	21	37	53	69	85	101	117	133	149	165	181	197	213	229	245
6	22	38	54	70	86	102	118	134	150	166	182	198	214	230	246
7	23	39	55	71	87	103	119	135	151	167	183	199	215	231	247
8	24	40	56	72	88	104	120	136	152	168	184	200	216	232	248
9	25	41	57	73	89	105	121	137	153	169	185	201	217	233	249
A	26	42	58	74	90	106	122	138	154	170	186	202	218	234	250
B	27	43	59	75	91	107	123	139	155	171	187	203	219	235	251
C	28	44	60	76	92	108	124	140	156	172	188	204	220	236	252
D	29	45	61	77	93	109	125	141	157	173	189	205	221	237	253
E	30	46	62	78	94	110	126	142	158	174	190	206	222	238	254
F	31	47	63	79	95	111	127	143	159	175	191	207	223	239	255

LaserJet Symbol Sets

ISO-60 Norway (0D)

0	1	2	3	4	5	6	7	8	9	A	B	C	D	E	F
0	16	32	48	64	80	96	112	128	144	160	176	192	208	224	240
1	17	33	49	65	81	97	113	129	145	161	177	193	209	225	241
2	18	34	50	66	82	98	114	130	146	162	178	194	210	226	242
3	19	35	51	67	83	99	115	131	147	163	179	195	211	227	243
4	20	36	52	68	84	100	116	132	148	164	180	196	212	228	244
5	21	37	53	69	85	101	117	133	149	165	181	197	213	229	245
6	22	38	54	70	86	102	118	134	150	166	182	198	214	230	246
7	23	39	55	71	87	103	119	135	151	167	183	199	215	231	247
8	24	40	56	72	88	104	120	136	152	168	184	200	216	232	248
9	25	41	57	73	89	105	121	137	153	169	185	201	217	233	249
A	26	42	58	74	90	106	122	138	154	170	186	202	218	234	250
B	27	43	59	75	91	107	123	139	155	171	187	203	219	235	251
C	28	44	60	76	92	108	124	140	156	172	188	204	220	236	252
D	29	45	61	77	93	109	125	141	157	173	189	205	221	237	253
E	30	46	62	78	94	110	126	142	158	174	190	206	222	238	254
F	31	47	63	79	95	111	127	143	159	175	191	207	223	239	255

ISO 11 Sweden (0S)

0	1	2	3	4	5	6	7	8	9	A	B	C	D	E	F	
0	0	16	32	48	64	80	96	112	128	144	160	176	192	208	224	240
1	1	17	33	49	65	81	97	113	129	145	161	177	193	209	225	241
2	2	18	34	50	66	82	98	114	130	146	162	178	194	210	226	242
3	3	19	35	51	67	83	99	115	131	147	163	179	195	211	227	243
4	4	20	36	52	68	84	100	116	132	148	164	180	196	212	228	244
5	5	21	37	53	69	85	101	117	133	149	165	181	197	213	229	245
6	6	22	38	54	70	86	102	118	134	150	166	182	198	214	230	246
7	7	23	39	55	71	87	103	119	135	151	167	183	199	215	231	247
8	8	24	40	56	72	88	104	120	136	152	168	184	200	216	232	248
9	9	25	41	57	73	89	105	121	137	153	169	185	201	217	233	249
A	10	26	42	58	74	90	106	122	138	154	170	186	202	218	234	250
B	11	27	43	59	75	91	107	123	139	155	171	187	203	219	235	251
C	12	28	44	60	76	92	108	124	140	156	172	188	204	220	236	252
D	13	29	45	61	77	93	109	125	141	157	173	189	205	221	237	253
E	14	30	46	62	78	94	110	126	142	158	174	190	206	222	238	254
F	15	31	47	63	79	95	111	127	143	159	175	191	207	223	239	255

ECMA-94 Latin 1 (0N)

0	1	2	3	4	5	6	7	8	9	A	B	C	D	E	F	
0	0	16	32	48	64	80	96	112	128	144	160	176	192	208	224	240
1	1	17	33	49	65	81	97	113	129	145	161	177	193	209	225	241
2	2	18	34	50	66	82	98	114	130	146	162	178	194	210	226	242
3	3	19	35	51	67	83	99	115	131	147	163	179	195	211	227	243
4	4	20	36	52	68	84	100	116	132	148	164	180	196	212	228	244
5	5	21	37	53	69	85	101	117	133	149	165	181	197	213	229	245
6	6	22	38	54	70	86	102	118	134	150	166	182	198	214	230	246
7	7	23	39	55	71	87	103	119	135	151	167	183	199	215	231	247
8	8	24	40	56	72	88	104	120	136	152	168	184	200	216	232	248
9	9	25	41	57	73	89	105	121	137	153	169	185	201	217	233	249
A	10	26	42	58	74	90	106	122	138	154	170	186	202	218	234	250
B	11	27	43	59	75	91	107	123	139	155	171	187	203	219	235	251
C	12	28	44	60	76	92	108	124	140	156	172	188	204	220	236	252
D	13	29	45	61	77	93	109	125	141	157	173	189	205	221	237	253
E	14	30	46	62	78	94	110	126	142	158	174	190	206	222	238	254
F	15	31	47	63	79	95	111	127	143	159	175	191	207	223	239	255

ISO-4 U. K. (1E)

0	1	2	3	4	5	6	7	8	9	A	B	C	D	E	F
0	!	"	#	\$	%	&	'	(	)	*	:	;	<	,	-
1	!	"	#	\$	%	&	'	(	)	*	:	;	<	,	-
2	"	#	\$	%	&	'	(	)	*	:	;	<	,	-	.
3	#	\$	%	&	'	(	)	*	:	;	<	,	-	.	·
4	\$	%	&	'	(	)	*	:	;	<	,	-	.	·	Æ
5	%	&	'	(	)	*	:	;	<	,	-	.	·	Æ	Đ
6	&	'	(	)	*	:	;	<	,	-	.	·	·	Æ	μ
7	'	(	)	*	:	;	<	,	-	.	·	·	·	·	¶
8	(	)	*	:	;	<	,	-	.	·	·	·	·	·	¼
9	)	*	:	;	<	,	-	.	·	·	·	·	·	·	¾
A	*	:	;	<	,	-	.	·	·	·	·	·	·	·	-
B	:	;	<	,	-	.	·	·	·	·	·	·	·	·	—
C	;	<	,	-	.	·	·	·	·	·	·	·	·	·	—
D	<	,	-	.	·	·	·	·	·	·	·	·	·	·	—
E	,	-	.	·	·	·	·	·	·	·	·	·	·	·	—
F	-	.	·	·	·	·	·	·	·	·	·	·	·	·	—
A	.	·	·	·	·	·	·	·	·	·	·	·	·	·	·
B	·	·	·	·	·	·	·	·	·	·	·	·	·	·	·
C	·	·	·	·	·	·	·	·	·	·	·	·	·	·	·
D	·	·	·	·	·	·	·	·	·	·	·	·	·	·	·
E	·	·	·	·	·	·	·	·	·	·	·	·	·	·	·
F	·	·	·	·	·	·	·	·	·	·	·	·	·	·	·

ISO-6 ASCII (0U)

0	1	2	3	4	5	6	7	8	9	A	B	C	D	E	F
0	!	"	#	\$	%	&	'	(	)	*	:	;	<	,	-
1	!	"	#	\$	%	&	'	(	)	*	:	;	<	,	-
2	"	#	\$	%	&	'	(	)	*	:	;	<	,	-	.
3	#	\$	%	&	'	(	)	*	:	;	<	,	-	.	·
4	\$	%	&	'	(	)	*	:	;	<	,	-	.	·	Æ
5	%	&	'	(	)	*	:	;	<	,	-	.	·	Æ	Đ
6	&	'	(	)	*	:	;	<	,	-	.	·	·	Æ	μ
7	'	(	)	*	:	;	<	,	-	.	·	·	·	·	¶
8	(	)	*	:	;	<	,	-	.	·	·	·	·	·	¼
9	)	*	:	;	<	,	-	.	·	·	·	·	·	·	¾
A	*	:	;	<	,	-	.	·	·	·	·	·	·	·	-
B	:	;	<	,	-	.	·	·	·	·	·	·	·	·	—
C	;	<	,	-	.	·	·	·	·	·	·	·	·	·	—
D	<	,	-	.	·	·	·	·	·	·	·	·	·	·	—
E	,	-	.	·	·	·	·	·	·	·	·	·	·	·	—
F	-	.	·	·	·	·	·	·	·	·	·	·	·	·	—
A	.	·	·	·	·	·	·	·	·	·	·	·	·	·	·
B	·	·	·	·	·	·	·	·	·	·	·	·	·	·	·
C	·	·	·	·	·	·	·	·	·	·	·	·	·	·	·
D	·	·	·	·	·	·	·	·	·	·	·	·	·	·	·
E	·	·	·	·	·	·	·	·	·	·	·	·	·	·	·
F	·	·	·	·	·	·	·	·	·	·	·	·	·	·	·

ISO-21 Germany (1G)

0	1	2	3	4	5	6	7	8	9	A	B	C	D	E	F
0	16	32	48	64	80	96	112	128	144	160	176	192	208	224	240
1	17	33	49	65	81	97	113	129	145	161	177	193	209	225	241
2	18	34	50	66	82	98	114	130	146	162	178	194	210	226	242
3	19	35	51	67	83	99	115	131	147	163	179	195	211	227	243
4	20	36	52	68	84	100	116	132	148	164	180	196	212	228	244
5	21	37	53	69	85	101	117	133	149	165	181	197	213	229	245
6	22	38	54	70	86	102	118	134	150	166	182	198	214	230	246
7	23	39	55	71	87	103	119	135	151	167	183	199	215	231	247
8	24	40	56	72	88	104	120	136	152	168	184	200	216	232	248
9	25	41	57	73	89	105	121	137	153	169	185	201	217	233	249
A	26	42	58	74	90	106	122	138	154	170	186	202	218	234	250
B	27	43	59	75	91	107	123	139	155	171	187	203	219	235	251
C	28	44	60	76	92	108	124	140	156	172	188	204	220	236	252
D	29	45	61	77	93	109	125	141	157	173	189	205	221	237	253
E	30	46	62	78	94	110	126	142	158	174	190	206	222	238	254
F	31	47	63	79	95	111	127	143	159	175	191	207	223	239	255

ISO-69 France (1F)

0	1	2	3	4	5	6	7	8	9	A	B	C	D	E	F
0	16	32	48	64	80	96	112	128	144	160	176	192	208	224	240
1	17	33	49	65	81	97	113	129	145	161	177	193	209	225	241
2	18	34	50	66	82	98	114	130	146	162	178	194	210	226	242
3	19	35	51	67	83	99	115	131	147	163	179	195	211	227	243
4	20	36	52	68	84	100	116	132	148	164	180	196	212	228	244
5	21	37	53	69	85	101	117	133	149	165	181	197	213	229	245
6	22	38	54	70	86	102	118	134	150	166	182	198	214	230	246
7	23	39	55	71	87	103	119	135	151	167	183	199	215	231	247
8	24	40	56	72	88	104	120	136	152	168	184	200	216	232	248
9	25	41	57	73	89	105	121	137	153	169	185	201	217	233	249
A	26	42	58	74	90	106	122	138	154	170	186	202	218	234	250
B	27	43	59	75	91	107	123	139	155	171	187	203	219	235	251
C	28	44	60	76	92	108	124	140	156	172	188	204	220	236	252
D	29	45	61	77	93	109	125	141	157	173	189	205	221	237	253
E	30	46	62	78	94	110	126	142	158	174	190	206	222	238	254
F	31	47	63	79	95	111	127	143	159	175	191	207	223	239	255



ISO Latin 2 (2N)

	0	1	2	3	4	5	6	7	8	9	A	B	C	D	E	F
0	0	16	32	48	64	80	96	112	128	144	160	176	192	208	224	240
1	!	17	33	49	65	81	97	113	129	145	161	177	193	209	225	241
2	"	18	34	50	66	82	98	114	130	146	162	178	194	210	226	242
3	#	19	35	51	67	83	99	115	131	147	163	179	195	211	227	243
4	\$	20	36	52	68	84	100	116	132	148	164	180	196	212	228	244
5	%	21	37	53	69	85	101	117	133	149	165	181	197	213	229	245
6	&	22	38	54	70	86	102	118	134	150	166	182	198	214	230	246
7	'	23	39	55	71	87	103	119	135	151	167	183	199	215	231	247
8	(	24	40	56	72	88	104	120	136	152	168	184	200	216	232	248
9	)	25	41	57	73	89	105	121	137	153	169	185	201	217	233	249
A	*	26	42	58	74	90	106	122	138	154	170	186	202	218	234	250
B	+	27	43	59	75	91	107	123	139	155	171	187	203	219	235	251
C	,	28	44	60	76	92	108	124	140	156	172	188	204	220	236	252
D	-	29	45	61	77	93	109	125	141	157	173	189	205	221	237	253
E	.	30	46	62	78	94	110	126	142	158	174	190	206	222	238	254
F	/	31	47	63	79	95	111	127	143	159	175	191	207	223	239	255

US Legal (1U)

	0	1	2	3	4	5	6	7	8	9	A	B	C	D	E	F
0	0	16	32	48	64	80	96	112	128	144	160	176	192	208	224	240
1	!	17	33	49	65	81	97	113	129	145	161	177	193	209	225	241
2	"	18	34	50	66	82	98	114	130	146	162	178	194	210	226	242
3	#	19	35	51	67	83	99	115	131	147	163	179	195	211	227	243
4	\$	20	36	52	68	84	100	116	132	148	164	180	196	212	228	244
5	%	21	37	53	69	85	101	117	133	149	165	181	197	213	229	245
6	&	22	38	54	70	86	102	118	134	150	166	182	198	214	230	246
7	'	23	39	55	71	87	103	119	135	151	167	183	199	215	231	247
8	(	24	40	56	72	88	104	120	136	152	168	184	200	216	232	248
9	)	25	41	57	73	89	105	121	137	153	169	185	201	217	233	249
A	*	26	42	58	74	90	106	122	138	154	170	186	202	218	234	250
B	+	27	43	59	75	91	107	123	139	155	171	187	203	219	235	251
C	,	28	44	60	76	92	108	124	140	156	172	188	204	220	236	252
D	-	29	45	61	77	93	109	125	141	157	173	189	205	221	237	253
E	.	30	46	62	78	94	110	126	142	158	174	190	206	222	238	254
F	/	31	47	63	79	95	111	127	143	159	175	191	207	223	239	255

PC Cyrillic (3R)

	0	1	2	3	4	5	6	7	8	9	A	B	C	D	E	F
0	▶	◀	!	@	P	`	~	p	A	Р	а	⌨	⌨	⌨	Р	Ё
1	☺	☹	!"	1	A	Q	a	q	Б	С	б	⌨	⌨	⌨	с	ё
2	☺	☹	"	2	B	R	b	r	В	Т	в	⌨	⌨	⌨	т	ѐ
3	♥	!!	#	3	C	S	c	s	Г	У	г	⌨	⌨	⌨	у	є
4	♦	!\$	\$	4	D	T	d	t	Д	Ф	д	⌨	⌨	⌨	ф	ї
5	♣	§	%	5	E	U	e	u	Е	Х	е	⌨	⌨	⌨	х	і
6	♠	-	&	6	F	V	f	v	Ж	Ц	ж	⌨	⌨	⌨	ц	ў
7	●	↑	'	7	G	W	g	w	З	Ч	з	⌨	⌨	⌨	ч	ы
8	◼	↑	(	8	H	X	h	x	И	Ш	и	⌨	⌨	⌨	ш	о
9	○	↓	)	9	I	Y	i	y	Й	Щ	й	⌨	⌨	⌨	щ	.
A	◼	→	*	:	J	Z	j	z	К	Ъ	к	⌨	⌨	⌨	ъ	.
B	♂	←	+	;	K	[	k	{	Л	Ы	л	⌨	⌨	⌨	ы	√
C	♀	⌞	,	<	L	\	l		М	Ь	м	⌨	⌨	⌨	ь	№
D	♫	↔	-	=	M	]	m	}	Н	Э	н	⌨	⌨	⌨	э	α
E	♫	▲	.	>	N	^	n	~	О	Ю	о	⌨	⌨	⌨	ю	■
F	☼	▼	/	?	O	_	o	◊	П	Я	п	⌨	⌨	⌨	я	■

ISO-17 Spain (2S)

	0	1	2	3	4	5	6	7	8	9	A	B	C	D	E	F
0			0	§	P	`	~	p			À	Á	Â	Ã	Ä	Å
1			1	A	Q	a	á	q			À	Á	Â	Ã	Ä	Å
2			2	B	R	b	á	r			À	Á	Â	Ã	Ä	Å
3		£	3	C	S	c	°	s			È	É	Ê	Ë	Ï	Ð
4			4	D	T	d	Ç	t			È	É	Ê	Ë	Ï	Ð
5			5	E	U	e	ç	u			È	É	Ê	Ë	Ï	Ð
6			6	F	V	f	ñ	v			È	É	Ê	Ë	Ï	Ð
7			7	G	W	g	ñ	w			È	É	Ê	Ë	Ï	Ð
8			8	H	X	h	í	x			È	É	Ê	Ë	Ï	Ð
9			9	I	Y	i	í	y			È	É	Ê	Ë	Ï	Ð
A			A	J	Z	j	í	z			È	É	Ê	Ë	Ï	Ð
B			B	K	[	k	í	{			È	É	Ê	Ë	Ï	Ð
C			C	L	Ñ	l	í	ñ			È	É	Ê	Ë	Ï	Ð
D			D	ç	í	ç	í	ç			È	É	Ê	Ë	Ï	Ð
E			E	ˆ	N	ˆ	í	n			È	É	Ê	Ë	Ï	Ð
F			F	ç	í	ç	í	ç			È	É	Ê	Ë	Ï	Ð

ISO Latin 5 (5N)

0	1	2	3	4	5	6	7	8	9	A	B	C	D	E	F
0	!	0	@	P	Q	R	p			o	A	G	a	g	
1	"	1	A	Q	a	q			i	±	Á	Ñ	á	ñ	
2	#	2	B	R	b	r			φ	2	Â	Ò	â	ò	
3	\$	3	C	S	c	s			£	3	Ã	Ó	ã	ó	
4	%	4	D	T	d	t			¤	'	Ä	Ô	ä	ô	
5	&	5	E	U	e	u			¥	μ	Å	Õ	å	õ	
6	'	6	F	V	f	v			¦	¶	Æ	Ö	æ	ö	
7	(	7	G	W	g	w			§	·	Ç	×	ç	÷	
8	)	8	H	X	h	x			¨	,	È	Ø	è	ø	
9	*	9	I	Y	i	y			©	¡	É	Ù	é	ù	
A	+	A	J	Z	j	z			ª	º	Ê	Ú	ê	ú	
B	=	B	K	[	k	{			«	»	Ë	Û	ë	û	
C	<	C	L	\	l				¬	¼	Ì	Ü	ì	ü	
D	-	D	=	M	]	}			-	½	Í	Ý	í	ý	
E	.	E	>	N	^	~			®	¾	Î	Ş	î	ş	
F	/	F	?	O	_	o					Ï	ß	ï	ÿ	

PS math (5M)

0	1	2	3	4	5	6	7	8	9	A	B	C	D	E	F
0	π	0	Π	≡	∏	—				°	∞	∠	∠	∠	€
1	θ	1	Α	Θ	α	α				±	±	∓	∓	∓	)
2	ρ	2	B	P	β	β				'	"	℞	℞	℞	∫
3	σ	3	X	Σ	χ	χ				≤	≥	≤	≥	≤	∫
4	τ	4	Δ	T	δ	δ				/	×	⊗	TM	TM	
5	υ	5	E	Υ	ε	ε				∞	∞	⊕	Π	Σ	J
6	φ	6	Φ	ϕ	φ	φ				f	∂	∅	∅	∅	J
7	ω	7	Γ	Ω	γ	γ				♣	•	∩	∩	∩	
8	ξ	8	H	Ξ	η	η				♦	÷	∪	∪	∪	J
9	ψ	9	I	Ψ	ι	ι				♥	≠	≠	≠	≠	J
A	ζ	A	∅	Z	φ	φ				♠	≡	≡	≡	≡	J
B	{	B	K	[	k	{				↔	≈	≈	≈	≈	J
C		C	Λ	∴	λ					←	⋮	⋮	⋮	⋮	J
D	}	D	=	M	μ	}				↑		≤	≤	≤	J
E	~	E	>	N	ν	~				→	—	⇒	⇒	⇒	J
F	o	F	?	O	_	o				↓	↙	↘	↘	↘	

MS publishing (6J)

	0	1	2	3	4	5	6	7	8	9	A	B	C	D	E	F
0	0	16	32	48	64	80	96	112	128	144	160	176	192	208	224	240
1	1	17	33	49	65	81	97	113	129	145	161	177	193	209	225	241
2	2	18	34	50	66	82	98	114	130	146	162	178	194	210	226	242
3	3	19	35	51	67	83	99	115	131	147	163	179	195	211	227	243
4	4	20	36	52	68	84	100	116	132	148	164	180	196	212	228	244
5	5	21	37	53	69	85	101	117	133	149	165	181	197	213	229	245
6	6	22	38	54	70	86	102	118	134	150	166	182	198	214	230	246
7	7	23	39	55	71	87	103	119	135	151	167	183	199	215	231	247
8	8	24	40	56	72	88	104	120	136	152	168	184	200	216	232	248
9	9	25	41	57	73	89	105	121	137	153	169	185	201	217	233	249
A	10	26	42	58	74	90	106	122	138	154	170	186	202	218	234	250
B	11	27	43	59	75	91	107	123	139	155	171	187	203	219	235	251
C	12	28	44	60	76	92	108	124	140	156	172	188	204	220	236	252
D	13	29	45	61	77	93	109	125	141	157	173	189	205	221	237	253
E	14	30	46	62	78	94	110	126	142	158	174	190	206	222	238	254
F	15	31	47	63	79	95	111	127	143	159	175	191	207	223	239	255

Windows Latin 5 (5T)

	0	1	2	3	4	5	6	7	8	9	A	B	C	D	E	F
0	0	16	32	48	64	80	96	112	128	144	160	176	192	208	224	240
1	1	17	33	49	65	81	97	113	129	145	161	177	193	209	225	241
2	2	18	34	50	66	82	98	114	130	146	162	178	194	210	226	242
3	3	19	35	51	67	83	99	115	131	147	163	179	195	211	227	243
4	4	20	36	52	68	84	100	116	132	148	164	180	196	212	228	244
5	5	21	37	53	69	85	101	117	133	149	165	181	197	213	229	245
6	6	22	38	54	70	86	102	118	134	150	166	182	198	214	230	246
7	7	23	39	55	71	87	103	119	135	151	167	183	199	215	231	247
8	8	24	40	56	72	88	104	120	136	152	168	184	200	216	232	248
9	9	25	41	57	73	89	105	121	137	153	169	185	201	217	233	249
A	10	26	42	58	74	90	106	122	138	154	170	186	202	218	234	250
B	11	27	43	59	75	91	107	123	139	155	171	187	203	219	235	251
C	12	28	44	60	76	92	108	124	140	156	172	188	204	220	236	252
D	13	29	45	61	77	93	109	125	141	157	173	189	205	221	237	253
E	14	30	46	62	78	94	110	126	142	158	174	190	206	222	238	254
F	15	31	47	63	79	95	111	127	143	159	175	191	207	223	239	255

ISO Latin 6 (6N)

0	1	2	3	4	5	6	7	8	9	A	B	C	D	E	F
0	0	16	32	48	64	80	96	112	128	144	160	176	192	208	224
1	!	"	#	\$	%	&	'	(	)	*	:	;	<	=	>
2	!	"	#	\$	%	&	'	(	)	*	:	;	<	=	>
3	!	"	#	\$	%	&	'	(	)	*	:	;	<	=	>
4	!	"	#	\$	%	&	'	(	)	*	:	;	<	=	>
5	!	"	#	\$	%	&	'	(	)	*	:	;	<	=	>
6	!	"	#	\$	%	&	'	(	)	*	:	;	<	=	>
7	!	"	#	\$	%	&	'	(	)	*	:	;	<	=	>
8	!	"	#	\$	%	&	'	(	)	*	:	;	<	=	>
9	!	"	#	\$	%	&	'	(	)	*	:	;	<	=	>
A	!	"	#	\$	%	&	'	(	)	*	:	;	<	=	>
B	!	"	#	\$	%	&	'	(	)	*	:	;	<	=	>
C	!	"	#	\$	%	&	'	(	)	*	:	;	<	=	>
D	!	"	#	\$	%	&	'	(	)	*	:	;	<	=	>
E	!	"	#	\$	%	&	'	(	)	*	:	;	<	=	>
F	!	"	#	\$	%	&	'	(	)	*	:	;	<	=	>

Desktop (7J)

0	1	2	3	4	5	6	7	8	9	A	B	C	D	E	F
0	0	16	32	48	64	80	96	112	128	144	160	176	192	208	224
1	!	"	#	\$	%	&	'	(	)	*	:	;	<	=	>
2	!	"	#	\$	%	&	'	(	)	*	:	;	<	=	>
3	!	"	#	\$	%	&	'	(	)	*	:	;	<	=	>
4	!	"	#	\$	%	&	'	(	)	*	:	;	<	=	>
5	!	"	#	\$	%	&	'	(	)	*	:	;	<	=	>
6	!	"	#	\$	%	&	'	(	)	*	:	;	<	=	>
7	!	"	#	\$	%	&	'	(	)	*	:	;	<	=	>
8	!	"	#	\$	%	&	'	(	)	*	:	;	<	=	>
9	!	"	#	\$	%	&	'	(	)	*	:	;	<	=	>
A	!	"	#	\$	%	&	'	(	)	*	:	;	<	=	>
B	!	"	#	\$	%	&	'	(	)	*	:	;	<	=	>
C	!	"	#	\$	%	&	'	(	)	*	:	;	<	=	>
D	!	"	#	\$	%	&	'	(	)	*	:	;	<	=	>
E	!	"	#	\$	%	&	'	(	)	*	:	;	<	=	>
F	!	"	#	\$	%	&	'	(	)	*	:	;	<	=	>

Math-8 (8M)

0	1	2	3	4	5	6	7	8	9	A	B	C	D	E	F
0	0	16	32	48	64	80	96	112	128	144	160	176	192	208	224
1	1	17	33	49	65	81	97	113	129	145	161	177	193	209	225
2	2	18	34	50	66	82	98	114	130	146	162	178	194	210	226
3	3	19	35	51	67	83	99	115	131	147	163	179	195	211	227
4	4	20	36	52	68	84	100	116	132	148	164	180	196	212	228
5	5	21	37	53	69	85	101	117	133	149	165	181	197	213	229
6	6	22	38	54	70	86	102	118	134	150	166	182	198	214	230
7	7	23	39	55	71	87	103	119	135	151	167	183	199	215	231
8	8	24	40	56	72	88	104	120	136	152	168	184	200	216	232
9	9	25	41	57	73	89	105	121	137	153	169	185	201	217	233
A	10	26	42	58	74	90	106	122	138	154	170	186	202	218	234
B	11	27	43	59	75	91	107	123	139	155	171	187	203	219	235
C	12	28	44	60	76	92	108	124	140	156	172	188	204	220	236
D	13	29	45	61	77	93	109	125	141	157	173	189	205	221	237
E	14	30	46	62	78	94	110	126	142	158	174	190	206	222	238
F	15	31	47	63	79	95	111	127	143	159	175	191	207	223	239

Greek-8 (8G)

0	1	2	3	4	5	6	7	8	9	A	B	C	D	E	F
0	0	16	32	48	64	80	96	112	128	144	160	176	192	208	224
1	1	17	33	49	65	81	97	113	129	145	161	177	193	209	225
2	2	18	34	50	66	82	98	114	130	146	162	178	194	210	226
3	3	19	35	51	67	83	99	115	131	147	163	179	195	211	227
4	4	20	36	52	68	84	100	116	132	148	164	180	196	212	228
5	5	21	37	53	69	85	101	117	133	149	165	181	197	213	229
6	6	22	38	54	70	86	102	118	134	150	166	182	198	214	230
7	7	23	39	55	71	87	103	119	135	151	167	183	199	215	231
8	8	24	40	56	72	88	104	120	136	152	168	184	200	216	232
9	9	25	41	57	73	89	105	121	137	153	169	185	201	217	233
A	10	26	42	58	74	90	106	122	138	154	170	186	202	218	234
B	11	27	43	59	75	91	107	123	139	155	171	187	203	219	235
C	12	28	44	60	76	92	108	124	140	156	172	188	204	220	236
D	13	29	45	61	77	93	109	125	141	157	173	189	205	221	237
E	14	30	46	62	78	94	110	126	142	158	174	190	206	222	238
F	15	31	47	63	79	95	111	127	143	159	175	191	207	223	239

HP Roman-8 (8U)

0	1	2	3	4	5	6	7	8	9	A	B	C	D	E	F	
0	0	16	32	48	64	80	96	112	128	144	160	176	192	208	224	240
1	1	17	33	49	65	81	97	113	129	145	161	177	193	209	225	241
2	2	18	34	50	66	82	98	114	130	146	162	178	194	210	226	242
3	3	19	35	51	67	83	99	115	131	147	163	179	195	211	227	243
4	4	20	36	52	68	84	100	116	132	148	164	180	196	212	228	244
5	5	21	37	53	69	85	101	117	133	149	165	181	197	213	229	245
6	6	22	38	54	70	86	102	118	134	150	166	182	198	214	230	246
7	7	23	39	55	71	87	103	119	135	151	167	183	199	215	231	247
8	8	24	40	56	72	88	104	120	136	152	168	184	200	216	232	248
9	9	25	41	57	73	89	105	121	137	153	169	185	201	217	233	249
A	10	26	42	58	74	90	106	122	138	154	170	186	202	218	234	250
B	11	27	43	59	75	91	107	123	139	155	171	187	203	219	235	251
C	12	28	44	60	76	92	108	124	140	156	172	188	204	220	236	252
D	13	29	45	61	77	93	109	125	141	157	173	189	205	221	237	253
E	14	30	46	62	78	94	110	126	142	158	174	190	206	222	238	254
F	15	31	47	63	79	95	111	127	143	159	175	191	207	223	239	255

Turkish-8 (8T)

0	1	2	3	4	5	6	7	8	9	A	B	C	D	E	F	
0	0	16	32	48	64	80	96	112	128	144	160	176	192	208	224	240
1	1	17	33	49	65	81	97	113	129	145	161	177	193	209	225	241
2	2	18	34	50	66	82	98	114	130	146	162	178	194	210	226	242
3	3	19	35	51	67	83	99	115	131	147	163	179	195	211	227	243
4	4	20	36	52	68	84	100	116	132	148	164	180	196	212	228	244
5	5	21	37	53	69	85	101	117	133	149	165	181	197	213	229	245
6	6	22	38	54	70	86	102	118	134	150	166	182	198	214	230	246
7	7	23	39	55	71	87	103	119	135	151	167	183	199	215	231	247
8	8	24	40	56	72	88	104	120	136	152	168	184	200	216	232	248
9	9	25	41	57	73	89	105	121	137	153	169	185	201	217	233	249
A	10	26	42	58	74	90	106	122	138	154	170	186	202	218	234	250
B	11	27	43	59	75	91	107	123	139	155	171	187	203	219	235	251
C	12	28	44	60	76	92	108	124	140	156	172	188	204	220	236	252
D	13	29	45	61	77	93	109	125	141	157	173	189	205	221	237	253
E	14	30	46	62	78	94	110	126	142	158	174	190	206	222	238	254
F	15	31	47	63	79	95	111	127	143	159	175	191	207	223	239	255

Windows Greek (9G)

	0	1	2	3	4	5	6	7	8	9	A	B	C	D	E	F
0				0	@	P	`	p	€			°	ı	Π	Û	π
1		!	1	1	A	Q	a	q		‘	±	±	A	P	α	ρ
2		"	2	2	B	R	b	r	,	’	²	²	B		β	ς
3		#	3	3	C	S	c	s	f	“	£	£	Γ	Σ	γ	σ
4		\$	4	4	D	T	d	t	”	”	¤	’	Δ	T	δ	τ
5		%	5	5	E	U	e	u	…	•	¥	μ	E	Υ	ε	υ
6		&	6	6	F	V	f	v	†	-	ı	ı	Z	Φ	ζ	φ
7		'	7	7	G	W	w	w	‡	—	§	·	H	X	η	χ
8		(	8	8	H	X	h	x			¨	’	Θ	Ψ	θ	ψ
9		)	9	9	I	Y	i	y	%	™	©	’	I	Ω	ι	ω
A		*	:	:	J	Z	j	z			ª	ı	K	İ	κ	ı
B		+	;	;	K	[	k	{	<	>	«	»	Λ	ÿ	λ	ÿ
C		,	<	<	L	\	l				¬	’	O	M	ά	ό
D		-	=	=	M	]	m	}			-	½	N	έ	ν	ύ
E		.	>	>	N	^	n	~			®	’	Y	Ε	ή	ξ
F		/	?	?	O	_	o	☒			—	’	Ω	O	ι	ο

Windows Latin 2 (9E)

	0	1	2	3	4	5	6	7	8	9	A	B	C	D	E	F
0				0	@	P	`	p	€			°	Ř	Đ	f	đ
1		!	1	1	A	Q	a	q		‘	±	±	Á	Ń	á	ń
2		"	2	2	B	R	b	r	,	’	²	²	Á	Ń	á	ń
3		#	3	3	C	S	c	s	“	“	Ł	ł	Ă	Ă	ă	ă
4		\$	4	4	D	T	d	t	”	”	¤	’	Ä	Ö	ä	ö
5		%	5	5	E	U	e	u	…	•	Å	μ	Ł	Ő	í	ő
6		&	6	6	F	V	f	v	†	-	ı	ı	Ć	Ö	ć	ö
7		'	7	7	G	W	w	w	‡	—	§	·	Ç	×	ç	÷
8		(	8	8	H	X	h	x			¨	’	Č	Ř	č	ř
9		)	9	9	I	Y	i	y	%	™	©	’	É	Û	é	ű
A		*	:	:	J	Z	j	z	Š	š	Š	š	È	Ú	è	ú
B		+	;	;	K	[	k	{	<	>	«	»	È	Û	ë	ű
C		,	<	<	L	\	l		Š	š	¬	’	Ě	Û	ě	ű
D		-	=	=	M	]	m	}	Ť	ť	-	”	Í	Ý	í	ý
E		.	>	>	N	^	n	~	Ž	ž	®	’	Î	Ť	î	ť
F		/	?	?	O	_	o	☒	Ž	ž	—	’	Ď	ß	ď	·



ISO Latin 9 (9N)

	0	1	2	3	4	5	6	7	8	9	A	B	C	D	E	F
0	0	16	32	48	64	80	96	112	128	144	160	176	192	208	224	240
1	1	17	33	49	65	81	97	113	129	145	161	177	193	209	225	241
2	2	18	34	50	66	82	98	114	130	146	162	178	194	210	226	242
3	3	19	35	51	67	83	99	115	131	147	163	179	195	211	227	243
4	4	20	36	52	68	84	100	116	132	148	164	180	196	212	228	244
5	5	21	37	53	69	85	101	117	133	149	165	181	197	213	229	245
6	6	22	38	54	70	86	102	118	134	150	166	182	198	214	230	246
7	7	23	39	55	71	87	103	119	135	151	167	183	199	215	231	247
8	8	24	40	56	72	88	104	120	136	152	168	184	200	216	232	248
9	9	25	41	57	73	89	105	121	137	153	169	185	201	217	233	249
A	10	26	42	58	74	90	106	122	138	154	170	186	202	218	234	250
B	11	27	43	59	75	91	107	123	139	155	171	187	203	219	235	251
C	12	28	44	60	76	92	108	124	140	156	172	188	204	220	236	252
D	13	29	45	61	77	93	109	125	141	157	173	189	205	221	237	253
E	14	30	46	62	78	94	110	126	142	158	174	190	206	222	238	254
F	15	31	47	63	79	95	111	127	143	159	175	191	207	223	239	255

PC-1004 (9J)

	0	1	2	3	4	5	6	7	8	9	A	B	C	D	E	F
0	0	16	32	48	64	80	96	112	128	144	160	176	192	208	224	240
1	1	17	33	49	65	81	97	113	129	145	161	177	193	209	225	241
2	2	18	34	50	66	82	98	114	130	146	162	178	194	210	226	242
3	3	19	35	51	67	83	99	115	131	147	163	179	195	211	227	243
4	4	20	36	52	68	84	100	116	132	148	164	180	196	212	228	244
5	5	21	37	53	69	85	101	117	133	149	165	181	197	213	229	245
6	6	22	38	54	70	86	102	118	134	150	166	182	198	214	230	246
7	7	23	39	55	71	87	103	119	135	151	167	183	199	215	231	247
8	8	24	40	56	72	88	104	120	136	152	168	184	200	216	232	248
9	9	25	41	57	73	89	105	121	137	153	169	185	201	217	233	249
A	10	26	42	58	74	90	106	122	138	154	170	186	202	218	234	250
B	11	27	43	59	75	91	107	123	139	155	171	187	203	219	235	251
C	12	28	44	60	76	92	108	124	140	156	172	188	204	220	236	252
D	13	29	45	61	77	93	109	125	141	157	173	189	205	221	237	253
E	14	30	46	62	78	94	110	126	142	158	174	190	206	222	238	254
F	15	31	47	63	79	95	111	127	143	159	175	191	207	223	239	255

PC-Turkish (9T)

	0	1	2	3	4	5	6	7	8	9	A	B	C	D	E	F
0	◀	▶	0	@	P	`	ç	ş	ı	ı	ı	ı	ı	ı	ı	ı
1	☺	☹	!	1	A	Q	a	q	ü	æ	ı	ı	ı	ı	ı	ı
2	↕	↕	"	2	B	R	b	r	é	Æ	ó	ı	ı	ı	ı	ı
3	♥	♣	#	3	C	S	c	s	â	ô	ú	ı	ı	ı	ı	ı
4	♠	♣	\$	4	D	T	d	t	ä	ö	ñ	ı	ı	ı	ı	ı
5	♣	♣	%	5	E	U	e	u	à	ò	ñ	ı	ı	ı	ı	ı
6	♣	♣	&	6	F	V	f	v	â	û	ğ	ı	ı	ı	ı	ı
7	•	↕	'	7	G	W	g	w	ç	ğ	ğ	ı	ı	ı	ı	ı
8	■	↑	(	8	H	X	h	x	ê	î	î	ı	ı	ı	ı	ı
9	○	↓	)	9	I	Y	i	y	ë	ö	ö	ı	ı	ı	ı	ı
A	☑	→	*	:	J	Z	j	z	è	ü	ü	ı	ı	ı	ı	ı
B	♂	←	+	:	K	[	k	{	ï	ø	½	ı	ı	ı	ı	ı
C	♀	L	,	<	L	\	l		î	£	¼	ı	ı	ı	ı	ı
D	♪	↔	-	=	M	]	m	}	ı	¥	ı	ı	ı	ı	ı	ı
E	♫	▲	.	>	N	^	n	~	Ä	Ş	«	ı	ı	ı	ı	ı
F	☀	▼	/	?	O	_	o	◊	Å	ş	»	ı	ı	ı	ı	ı

Win Cyrillic (9R)

	0	1	2	3	4	5	6	7	8	9	A	B	C	D	E	F
0				0	@	P	`	р	ѣ	ђ	°	°	А	Р	а	Р
1			!	1	A	Q	±	q	ѓ	ѓ	±	±	Б	С	б	с
2			"	2	B	R	ı	r	ѣ	ѣ	ı	ı	В	Т	в	т
3			#	3	C	S	ı	s	ѓ	ѓ	ı	ı	Г	У	г	у
4			\$	4	D	T	ı	t	ѣ	ѣ	ı	ı	Д	Ф	д	ф
5			%	5	E	U	ı	u	...	•	ı	ı	Е	Х	е	х
6			&	6	F	V	ı	v	†	-	ı	ı	Ф	Ж	ф	ж
7			'	7	G	W	ı	w	‡	—	ı	ı	Ж	Ц	ж	ц
8			(	8	H	X	ı	x	€	€	ı	ı	Ц	З	ц	з
9			)	9	I	Y	ı	y	‰	‰	ı	ı	З	И	з	и
A			*	:	J	Z	ı	z	љ	љ	ı	ı	И	Ш	и	ш
B			+	:	K	[	ı	{	ѣ	ѣ	ı	ı	Ш	Щ	ш	щ
C			,	<	L	\	ı		љ	љ	ı	ı	Щ	Ъ	щ	ъ
D			-	=	M	]	ı	}	ѣ	ѣ	ı	ı	Ъ	Ы	ъ	ы
E			.	>	N	^	ı	~	ѣ	ѣ	ı	ı	Ы	Ь	ы	ь
F			/	?	O	_	ı	◊	ѣ	ѣ	ı	ı	Ь	Э	ь	э

PC-851 Greek (10G)

	0	1	2	3	4	5	6	7	8	9	A	B	C	D	E	F
0	▶	◀	!	"	#	\$	%	&	'	↑	↓	◻	◻	◻	◻	◻
1	☺	☹	!	"	#	\$	%	&	'	↑	↓	◻	◻	◻	◻	◻
2	☺	☹	"	#	\$	%	&	'	↑	↓	◻	◻	◻	◻	◻	◻
3	♥	♠	#	\$	%	&	'	↑	↓	◻	◻	◻	◻	◻	◻	◻
4	♠	♣	\$	%	&	'	↑	↓	◻	◻	◻	◻	◻	◻	◻	◻
5	♣	♠	%	&	'	↑	↓	◻	◻	◻	◻	◻	◻	◻	◻	◻
6	♠	♣	&	'	↑	↓	◻	◻	◻	◻	◻	◻	◻	◻	◻	◻
7	●	◻	↑	↓	◻	◻	◻	◻	◻	◻	◻	◻	◻	◻	◻	◻
8	◻	◻	(	)	*	:	;	+	,	¼	½	¾	◻	◻	◻	◻
9	◻	◻	)	*	:	;	+	,	¼	½	¾	◻	◻	◻	◻	◻
A	◻	◻	*	:	;	+	,	¼	½	¾	◻	◻	◻	◻	◻	◻
B	♂	♀	<	>	.	/	◻	◻	◻	◻	◻	◻	◻	◻	◻	◻
C	♀	♂	<	>	.	/	◻	◻	◻	◻	◻	◻	◻	◻	◻	◻
D	♫	♫	-	=	N	^	~	»	«	€	£	¤	¥	¦	§	¨
E	♫	♫	-	=	N	^	~	»	«	€	£	¤	¥	¦	§	¨
F	☼	☼	/	?	O	_	o	◻	◻	◻	◻	◻	◻	◻	◻	◻

Windows (9U)

	0	1	2	3	4	5	6	7	8	9	A	B	C	D	E	F
0	◻	◻	◻	◻	◻	◻	◻	◻	◻	◻	◻	◻	◻	◻	◻	◻
1	◻	◻	!	"	#	\$	%	&	'	↑	↓	◻	◻	◻	◻	◻
2	◻	◻	"	#	\$	%	&	'	↑	↓	◻	◻	◻	◻	◻	◻
3	◻	◻	#	\$	%	&	'	↑	↓	◻	◻	◻	◻	◻	◻	◻
4	◻	◻	\$	%	&	'	↑	↓	◻	◻	◻	◻	◻	◻	◻	◻
5	◻	◻	%	&	'	↑	↓	◻	◻	◻	◻	◻	◻	◻	◻	◻
6	◻	◻	&	'	↑	↓	◻	◻	◻	◻	◻	◻	◻	◻	◻	◻
7	◻	◻	'	↑	↓	◻	◻	◻	◻	◻	◻	◻	◻	◻	◻	◻
8	◻	◻	(	)	*	:	;	+	,	¼	½	¾	◻	◻	◻	◻
9	◻	◻	)	*	:	;	+	,	¼	½	¾	◻	◻	◻	◻	◻
A	◻	◻	*	:	;	+	,	¼	½	¾	◻	◻	◻	◻	◻	◻
B	◻	◻	:	;	+	,	¼	½	¾	◻	◻	◻	◻	◻	◻	◻
C	◻	◻	;	+	,	¼	½	¾	◻	◻	◻	◻	◻	◻	◻	◻
D	◻	◻	+	,	¼	½	¾	◻	◻	◻	◻	◻	◻	◻	◻	◻
E	◻	◻	,	¼	½	¾	◻	◻	◻	◻	◻	◻	◻	◻	◻	◻
F	◻	◻	¼	½	¾	◻	◻	◻	◻	◻	◻	◻	◻	◻	◻	◻

ISO Cyrillic (10N)

	0	1	2	3	4	5	6	7	8	9	A	B	C	D	E	F
0	0	16	32	48	64	80	96	112	128	144	160	176	192	208	224	240
1	1	17	33	49	65	81	97	113	129	145	161	177	193	209	225	241
2	2	18	34	50	66	82	98	114	130	146	162	178	194	210	226	242
3	3	19	35	51	67	83	99	115	131	147	163	179	195	211	227	243
4	4	20	36	52	68	84	100	116	132	148	164	180	196	212	228	244
5	5	21	37	53	69	85	101	117	133	149	165	181	197	213	229	245
6	6	22	38	54	70	86	102	118	134	150	166	182	198	214	230	246
7	7	23	39	55	71	87	103	119	135	151	167	183	199	215	231	247
8	8	24	40	56	72	88	104	120	136	152	168	184	200	216	232	248
9	9	25	41	57	73	89	105	121	137	153	169	185	201	217	233	249
A	10	26	42	58	74	90	106	122	138	154	170	186	202	218	234	250
B	11	27	43	59	75	91	107	123	139	155	171	187	203	219	235	251
C	12	28	44	60	76	92	108	124	140	156	172	188	204	220	236	252
D	13	29	45	61	77	93	109	125	141	157	173	189	205	221	237	253
E	14	30	46	62	78	94	110	126	142	158	174	190	206	222	238	254
F	15	31	47	63	79	95	111	127	143	159	175	191	207	223	239	255

PS text (10J)

	0	1	2	3	4	5	6	7	8	9	A	B	C	D	E	F
0	0	16	32	48	64	80	96	112	128	144	160	176	192	208	224	240
1	1	17	33	49	65	81	97	113	129	145	161	177	193	209	225	241
2	2	18	34	50	66	82	98	114	130	146	162	178	194	210	226	242
3	3	19	35	51	67	83	99	115	131	147	163	179	195	211	227	243
4	4	20	36	52	68	84	100	116	132	148	164	180	196	212	228	244
5	5	21	37	53	69	85	101	117	133	149	165	181	197	213	229	245
6	6	22	38	54	70	86	102	118	134	150	166	182	198	214	230	246
7	7	23	39	55	71	87	103	119	135	151	167	183	199	215	231	247
8	8	24	40	56	72	88	104	120	136	152	168	184	200	216	232	248
9	9	25	41	57	73	89	105	121	137	153	169	185	201	217	233	249
A	10	26	42	58	74	90	106	122	138	154	170	186	202	218	234	250
B	11	27	43	59	75	91	107	123	139	155	171	187	203	219	235	251
C	12	28	44	60	76	92	108	124	140	156	172	188	204	220	236	252
D	13	29	45	61	77	93	109	125	141	157	173	189	205	221	237	253
E	14	30	46	62	78	94	110	126	142	158	174	190	206	222	238	254
F	15	31	47	63	79	95	111	127	143	159	175	191	207	223	239	255

PC-869 Greek (11G)

0	0	1	2	3	4	5	6	7	8	9	A	B	C	D	E	F
	▶	◀	!	"	#	\$	%	&	'	↑	↓	*	→	♂	♀	♁
0	16	32	48	64	80	96	112	128	144	160	176	192	208	224	240	240
1	17	33	49	65	81	97	113	129	145	161	177	193	209	225	241	241
2	18	34	50	66	82	98	114	130	146	162	178	194	210	226	242	242
3	19	35	51	67	83	99	115	131	147	163	179	195	211	227	243	243
4	20	36	52	68	84	100	116	132	148	164	180	196	212	228	244	244
5	21	37	53	69	85	101	117	133	149	165	181	197	213	229	245	245
6	22	38	54	70	86	102	118	134	150	166	182	198	214	230	246	246
7	23	39	55	71	87	103	119	135	151	167	183	199	215	231	247	247
8	24	40	56	72	88	104	120	136	152	168	184	200	216	232	248	248
9	25	41	57	73	89	105	121	137	153	169	185	201	217	233	249	249
A	26	42	58	74	90	106	122	138	154	170	186	202	218	234	250	250
B	27	43	59	75	91	107	123	139	155	171	187	203	219	235	251	251
C	28	44	60	76	92	108	124	140	156	172	188	204	220	236	252	252
D	29	45	61	77	93	109	125	141	157	173	189	205	221	237	253	253
E	30	46	62	78	94	110	126	142	158	174	190	206	222	238	254	254
F	31	47	63	79	95	111	127	143	159	175	191	207	223	239	255	255

PC-855 Serbia (10R)

0	0	1	2	3	4	5	6	7	8	9	A	B	C	D	E	F
	▶	◀	!	"	#	\$	%	&	'	↑	↓	*	→	♂	♀	♁
0	16	32	48	64	80	96	112	128	144	160	176	192	208	224	240	240
1	17	33	49	65	81	97	113	129	145	161	177	193	209	225	241	241
2	18	34	50	66	82	98	114	130	146	162	178	194	210	226	242	242
3	19	35	51	67	83	99	115	131	147	163	179	195	211	227	243	243
4	20	36	52	68	84	100	116	132	148	164	180	196	212	228	244	244
5	21	37	53	69	85	101	117	133	149	165	181	197	213	229	245	245
6	22	38	54	70	86	102	118	134	150	166	182	198	214	230	246	246
7	23	39	55	71	87	103	119	135	151	167	183	199	215	231	247	247
8	24	40	56	72	88	104	120	136	152	168	184	200	216	232	248	248
9	25	41	57	73	89	105	121	137	153	169	185	201	217	233	249	249
A	26	42	58	74	90	106	122	138	154	170	186	202	218	234	250	250
B	27	43	59	75	91	107	123	139	155	171	187	203	219	235	251	251
C	28	44	60	76	92	108	124	140	156	172	188	204	220	236	252	252
D	29	45	61	77	93	109	125	141	157	173	189	205	221	237	253	253
E	30	46	62	78	94	110	126	142	158	174	190	206	222	238	254	254
F	31	47	63	79	95	111	127	143	159	175	191	207	223	239	255	255

Macintosh (12J)

	0	1	2	3	4	5	6	7	8	9	A	B	C	D	E	F
0				0	@	P	`	p	Ä	ê	†	∞	í	—	—	🍏
1		!	"	1	A	Q	a	q	Å	ë	°	±	i	—	·	Ò
2		"	"	2	B	R	b	r	Ç	í	¢	≤	—	“	,	Ú
3		#	#	3	C	S	c	s	É	ì	£	≥	√	”	”	Û
4		\$	\$	4	D	T	d	t	Ñ	î	§	¥	f	‘	%	Ü
5		%	%	5	E	U	e	u	Ö	ï	•	μ	≈	’	Á	ı
6		&	&	6	F	V	f	v	Ü	ñ	¶	∅	Δ	÷	Ê	ˆ
7		'	'	7	G	W	g	w	á	ó	β	Σ	«	◊	Á	˜
8		(	(	8	H	X	h	x	à	ò	®	Π	»	ÿ	Ë	—
9		)	)	9	I	Y	i	y	â	ô	©	π	…	ÿ	È	˘
A		*	*	:	J	Z	j	z	ä	ö	™	∫	/	/	Í	·
B		+	+	;	K	[	k	{	ã	õ	'	ª	À	€	î	°
C		,	,	<	L	\	l		å	ú	..	º	Á	<	ï	,
D		-	-	=	M	]	m	}	ç	ù	≠	Ω	Ö	>	ì	”
E		.	.	>	N	^	n	~	é	û	Æ	æ	Œ	ƒ	ó	˘
F		/	/	?	O	_	o	ø	è	ü	Ø	ø	œ	ƒ	ô	˘

PC-8 Greek (12G)

	0	1	2	3	4	5	6	7	8	9	A	B	C	D	E	F
0		▶	◀	0	@	P	`	p	A	α	ι	⋮	L	⊥	ω	≡
1	☺	◀	▶	1	A	Q	a	q	B	β	κ	☒	⊥	⊥	α	±
2	☹	↕	↕	2	B	R	b	r	Γ	γ	λ	☒	⊥	⊥	ε	±
3	♥	!!	!!	3	C	S	c	s	Δ	δ	μ		⊥	⊥	η	≤
4	♦	¶	¶	4	D	T	d	t	E	ε	ν	⊥	⊥	⊥	ï	∫
5	♣	§	§	5	E	U	e	u	Z	ζ	ξ	⊥	⊥	⊥	ı	∫
6	♠	—	—	6	F	V	f	v	H	η	ο	⊥	⊥	⊥	ó	÷
7	●	↑	↑	7	G	W	g	w	Θ	θ	π	⊥	⊥	⊥	ú	≈
8	◼	↑	↑	8	H	X	h	x	I	ι	ρ	⊥	⊥	⊥	ü	°
9	◯	↓	↓	9	I	Y	i	y	K	κ	σ	⊥	⊥	⊥	ώ	·
A	◼	→	→	:	J	Z	j	z	Λ	λ	ς	⊥	⊥	⊥	Ω	·
B	♂	←	←	;	K	[	k	{	M	μ	τ	⊥	⊥	⊥	δ	√
C	♀	L	L	<	L	\	l		N	ν	υ	⊥	⊥	⊥	∞	∞
D	♫	↔	↔	=	M	]	m	}	E	ε	φ	⊥	⊥	⊥	φ	2
E	♫	▲	▲	>	N	^	n	~	O	ο	χ	⊥	⊥	⊥	€	■
F	☼	▼	▼	?	O	_	o	ø	◊	◊	ψ	⊥	⊥	⊥	∩	∩

USSR-GOST (12R)

	0	1	2	3	4	5	6	7	8	9	A	B	C	D	E	F
0	◀	◻	◻	0	@	P	`	р	≡	Г	А	Р	А	Р	а	Ё
1	☺	◀	!	1	A	Q	a	q	⌌	П	Б	С	Б	С	б	ё
2	☹	⬆	"	2	B	R	b	г	≡	Л	В	Т	В	Т	в	↙
3	♥	!!	#	3	C	S	c	s	≡	Л	Г	У	Г	У	г	↘
4	♠	⬆	\$	4	D	T	d	t	≡	—	Д	Ф	Д	Ф	д	↙
5	♣	§	%	5	E	U	e	u	≡		Е	Х	Е	Х	е	↘
6	♠	—	&	6	F	V	f	v	≡	≡	Ж	Ц	Ж	Ц	ж	→
7	●	⬆	'	7	G	W	g	w	≡	≡	З	Ч	З	Ч	з	←
8	◼	↑	(	8	H	X	h	x	≡	≡	И	Ш	И	Ш	и	↑
9	◯	↓	)	9	I	Y	i	y	≡	≡	Й	Щ	Й	Щ	й	↓
A	◼	→	*	:	J	Z	j	z	≡	≡	К	Ъ	К	Ъ	к	÷
B	♂	←	+	;	[	k	{	{	≡	≡	Л	Ы	Л	Ы	л	±
C	♀	└	,	<	\				≡	≡	М	Ь	М	Ь	м	№
D	♫	↔	-	=	] m	}	}	}	≡	≡	Н	Э	Н	Э	н	▣
E	♫	▲	.	>	^	ˆ	ˆ	ˆ	≡	≡	О	Ю	О	Ю	о	■
F	☼	▼	/	? o	o	o	o	o	≡	≡	П	Я	П	Я	п	я

ISO Greek (12N)

	0	1	2	3	4	5	6	7	8	9	A	B	C	D	E	F
0	◻	◻	◻	0	@	P	`	ρ	◻	◻	◻	◻	◻	Π	ϒ	π
1	◻	◻	!	1	A	Q	a	q	◻	◻	◻	◻	◻	Α	Ρ	α
2	◻	◻	"	2	B	R	b	г	◻	◻	◻	◻	◻	Β	β	ς
3	◻	◻	#	3	C	S	c	s	◻	◻	◻	◻	◻	Γ	Σ	γ
4	◻	◻	\$	4	D	T	d	t	◻	◻	◻	◻	◻	Δ	Τ	δ
5	◻	◻	%	5	E	U	e	υ	◻	◻	◻	◻	◻	Ε	Υ	ε
6	◻	◻	&	6	F	V	f	v	◻	◻	◻	◻	◻	Ζ	Φ	ζ
7	◻	◻	'	7	G	W	g	w	◻	◻	◻	◻	◻	Η	Χ	η
8	◻	◻	(	8	H	X	h	x	◻	◻	◻	◻	◻	Θ	Ψ	θ
9	◻	◻	)	9	I	Y	i	υ	◻	◻	◻	◻	◻	Ι	Ω	ι
A	◻	◻	*	:	J	Z	j	z	◻	◻	◻	◻	◻	Κ	Ϊ	κ
B	◻	◻	+	;	[	k	{	{	◻	◻	◻	◻	◻	Λ	ΰ	λ
C	◻	◻	,	<	\				◻	◻	◻	◻	◻	Ο	Μ	ο
D	◻	◻	-	=	] m	}	}	}	◻	◻	◻	◻	◻	Ν	Ε	ν
E	◻	◻	.	>	^	ˆ	ˆ	ˆ	◻	◻	◻	◻	◻	Υ	Ξ	ξ
F	◻	◻	/	? o	o	o	o	o	◻	◻	◻	◻	◻	Ω	Ο	ω

PC-8 Bulgarian (13R)

	0	1	2	3	4	5	6	7	8	9	A	B	C	D	E	F
0	▶	◀	!	@	P	`	~	р	А	Р	а	р	Л	⊠	α	≡
1	☺	☹	"	1	A	Q	a	q	Б	С	б	с	⊞	⊞	β	±
2	☼	☽	#	2	B	R	b	r	В	Т	в	т	⊞	⊞	Γ	≈
3	♥	!!	\$	3	C	S	c	s	Г	У	г	у	⊞	⊞	π	≤
4	♦	¶	%	4	D	T	d	t	Д	Ф	д	ф	⊞	⊞	Σ	f
5	♣	§	&	5	E	U	e	u	Е	Х	е	х	⊞	⊞	№	σ
6	♠	-	'	6	F	V	f	v	Ж	Ц	ж	ц	⊞	⊞	§	μ
7	●	↑	(	7	G	W	g	w	З	Ч	з	ч	⊞	⊞	⊞	≈
8	◼	↕	)	8	H	X	h	x	И	Ш	и	ш	⊞	⊞	⊞	°
9	○	↓	*	9	I	Y	i	y	Й	Щ	й	щ	⊞	⊞	⊞	·
A	◐	→	:	:	J	Z	j	z	К	Ъ	к	ъ	⊞	⊞	⊞	·
B	♂	←	;	;	K	L	k	l	Л	Ы	л	ы	⊞	⊞	⊞	√
C	♀	⊞	<	<	L	\	\		М	Ь	м	ь	⊞	⊞	⊞	∞
D	♫	↔	=	=	M	] m	] m	}	Н	Э	н	э	⊞	⊞	⊞	∞
E	♪	▲	.	.	N	^	^	~	О	Ю	о	ю	⊞	⊞	⊞	∞
F	☼	▼	/	/	O	_	_	◊	П	Я	п	я	⊞	⊞	⊞	∞

ABICOMP Brazil (13P)

	0	1	2	3	4	5	6	7	8	9	A	B	C	D	E	F
0				0	@	P	`	p			Ò	ì	ò			
1		!	"	1	A	Q	a	q			À	ó	à	ó		
2		"	#	2	B	R	b	r			Á	á	á	á		
3		#	\$	3	C	S	c	s			Â	â	â	â		
4		\$	%	4	D	T	d	t			Ã	ã	ã	ã		
5		%	&	5	E	U	e	u			Ä	ä	ä	ä		
6		&	'	6	F	V	f	v			Ç	ç	ç	ç		
7		'	(	7	G	W	g	w			È	è	è	è		
8		(	)	8	H	X	h	x			É	é	é	é		
9		)	*	9	I	Y	i	y			Ê	ê	ê	ê		
A		*	:	:	J	Z	j	z			Ë	ë	ë	ë		
B		:	;	;	K	Ö	k	ö			Ì	ì	ì	ì		
C		;	<	<	L	Ã	l	ã			Í	í	í	í		
D		<	=	=	M	Ç	m	ç			Î	î	î	î		
E		=	.	.	N	^	^	~			Ï	ï	ï	ï		
F		.	/	/	O	_	_	◊			Ñ	ñ	ñ	ñ		



ABICOMP Int. (14P)

0	1	2	3	4	5	6	7	8	9	A	B	C	D	E	F
0	!	"	#	\$	%	&	'	(	)	*	+	,	-	.	/
1	!	"	#	\$	%	&	'	(	)	*	+	,	-	.	/
2	"	#	\$	%	&	'	(	)	*	+	,	-	.	/	?
3	#	\$	%	&	'	(	)	*	+	,	-	.	/	?	o
4	\$	%	&	'	(	)	*	+	,	-	.	/	?	o	o
5	%	&	'	(	)	*	+	,	-	.	/	?	o	o	o
6	&	'	(	)	*	+	,	-	.	/	?	o	o	o	o
7	'	(	)	*	+	,	-	.	/	?	o	o	o	o	o
8	(	)	*	+	,	-	.	/	?	o	o	o	o	o	o
9	)	*	+	,	-	.	/	?	o	o	o	o	o	o	o
A	*	+	,	-	.	/	?	o	o	o	o	o	o	o	o
B	+	,	-	.	/	?	o	o	o	o	o	o	o	o	o
C	,	-	.	/	?	o	o	o	o	o	o	o	o	o	o
D	-	.	/	?	o	o	o	o	o	o	o	o	o	o	o
E	.	/	?	o	o	o	o	o	o	o	o	o	o	o	o
F	/	?	o	o	o	o	o	o	o	o	o	o	o	o	o

PC-8 Greek/437G (14G)

0	1	2	3	4	5	6	7	8	9	A	B	C	D	E	F
0	◀	▶	0	@	P	`	p	A	Π	ι	⋮	L	⊥	Ω	'Ω
1	☺	◀	!	A	Q	a	q	B	Σ	κ	☒	⊥	⊥	ά	±
2	☹	⬆	"	B	R	b	r	Γ	Τ	λ	☒	⊥	⊥	ε	±
3	♥	!!	#	C	S	c	s	Δ	Υ	μ		⊥	⊥	ή	≤
4	♦	⬆	\$	D	T	d	t	E	Φ	ν	⊥	⊥	⊥	ι	⊥
5	♣	§	%	E	U	e	u	Z	X	ξ	⊥	⊥	⊥	ί	J
6	♠	-	&	F	V	v	v	H	Ψ	ο	⊥	⊥	⊥	ό	÷
7	●	⬆	'	G	W	w	w	Θ	Ω	π	⊥	⊥	⊥	ύ	≈
8	◼	↑	(	H	X	x	x	I	α	ρ	⊥	⊥	⊥	ü	°
9	◯	↓	)	I	Y	y	y	K	β	σ	⊥	⊥	⊥	ö	°
A	◼	→	*	J	Z	z	z	Λ	γ	ς	⊥	⊥	⊥	á	.
B	♂	←	+	K	[	[	{	M	δ	τ	⊥	⊥	⊥	É	√
C	♀	L	,	L	\	\		N	ε	υ	⊥	⊥	⊥	Η	n
D	♪	↔	-	M	] m	] m	}	E	ζ	φ	⊥	⊥	⊥	Ι	2
E	♫	▲	>	N	^	^	~	O	η	χ	⊥	⊥	⊥	Ο	■
F	☼	▼	/	O	_	_	o	Π	θ	ψ	⊥	⊥	⊥	Υ	■

Pi font (15U)

0	1	2	3	4	5	6	7	8	9	A	B	C	D	E	F	
0	0	16	32	48	64	80	96	112	128	144	160	176	192	208	224	240
1	1	17	33	49	65	81	97	113	129	145	161	177	193	209	225	241
2	2	18	34	50	66	82	98	114	130	146	162	178	194	210	226	242
3	3	19	35	51	67	83	99	115	131	147	163	179	195	211	227	243
4	4	20	36	52	68	84	100	116	132	148	164	180	196	212	228	244
5	5	21	37	53	69	85	101	117	133	149	165	181	197	213	229	245
6	6	22	38	54	70	86	102	118	134	150	166	182	198	214	230	246
7	7	23	39	55	71	87	103	119	135	151	167	183	199	215	231	247
8	8	24	40	56	72	88	104	120	136	152	168	184	200	216	232	248
9	9	25	41	57	73	89	105	121	137	153	169	185	201	217	233	249
A	10	26	42	58	74	90	106	122	138	154	170	186	202	218	234	250
B	11	27	43	59	75	91	107	123	139	155	171	187	203	219	235	251
C	12	28	44	60	76	92	108	124	140	156	172	188	204	220	236	252
D	13	29	45	61	77	93	109	125	141	157	173	189	205	221	237	253
E	14	30	46	62	78	94	110	126	142	158	174	190	206	222	238	254
F	15	31	47	63	79	95	111	127	143	159	175	191	207	223	239	255

PC Ukrainian (14R)

0	1	2	3	4	5	6	7	8	9	A	B	C	D	E	F	
0	0	16	32	48	64	80	96	112	128	144	160	176	192	208	224	240
1	1	17	33	49	65	81	97	113	129	145	161	177	193	209	225	241
2	2	18	34	50	66	82	98	114	130	146	162	178	194	210	226	242
3	3	19	35	51	67	83	99	115	131	147	163	179	195	211	227	243
4	4	20	36	52	68	84	100	116	132	148	164	180	196	212	228	244
5	5	21	37	53	69	85	101	117	133	149	165	181	197	213	229	245
6	6	22	38	54	70	86	102	118	134	150	166	182	198	214	230	246
7	7	23	39	55	71	87	103	119	135	151	167	183	199	215	231	247
8	8	24	40	56	72	88	104	120	136	152	168	184	200	216	232	248
9	9	25	41	57	73	89	105	121	137	153	169	185	201	217	233	249
A	10	26	42	58	74	90	106	122	138	154	170	186	202	218	234	250
B	11	27	43	59	75	91	107	123	139	155	171	187	203	219	235	251
C	12	28	44	60	76	92	108	124	140	156	172	188	204	220	236	252
D	13	29	45	61	77	93	109	125	141	157	173	189	205	221	237	253
E	14	30	46	62	78	94	110	126	142	158	174	190	206	222	238	254
F	15	31	47	63	79	95	111	127	143	159	175	191	207	223	239	255

PC-852 Latin 2 (17U)

	0	1	2	3	4	5	6	7	8	9	A	B	C	D	E	F
0	▶	◀	↕	0	@	P	`	p	Ç	É	á	á	L	đ	Ó	-
1	☺	☹	↕	1	A	Q	a	q	ü	Í	í	í	⊥	Đ	ß	”
2	☺	☹	↕	2	B	R	b	r	é	Í	ó	ó	T	Ď	Ô	˘
3	♥	♠	♣	3	C	S	c	s	â	ô	ú	ú	F	Ě	Ň	ˇ
4	♦	♠	♣	4	D	T	d	t	ä	ö	á	á	-	đ	ń	˘
5	♣	♣	♣	5	E	U	e	u	ů	Ľ	á	á	+	Ň	ň	š
6	♠	♠	♠	6	F	V	f	v	ć	ř	ž	ž	+	Ā	ā	š
7	•	↕	↕	7	G	W	g	w	ç	š	ž	ž	+	ā	ā	š
8	■	↑	↑	8	H	X	h	x	ı	ś	ę	ę	+	ē	ē	ř
9	○	↓	↓	9	I	Y	i	y	ë	ö	ę	ę	+	Ĳ	Ĳ	ú
A	☑	→	→	A	J	Z	j	z	ó	ü	ü	ü	+	Ĳ	Ĳ	•
B	♂	←	←	B	K	[	k	{	ó	ř	ž	ž	+	■	■	ü
C	♀	L	L	C	L	\	l		ı	ř	č	č	+	■	■	ř
D	♪	↔	↔	D	=	M	]m	}	ž	ł	ş	ş	+	=	ı	ř
E	♫	▲	▲	E	>	N	^	~	Ä	×	«	«	+	≠	ı	ı
F	☀	▼	▼	F	? /	O	_	o	ć	»	»	»	+	ı	ı	ı

PC-857 Turkish (16U)

	0	1	2	3	4	5	6	7	8	9	A	B	C	D	E	F
0	▶	◀	↕	0	@	P	`	p	Ç	É	á	á	L	o	Ó	-
1	☺	☹	↕	1	A	Q	a	q	ü	æ	í	í	⊥	a	ß	±
2	☺	☹	↕	2	B	R	b	r	é	Æ	ó	ó	T	Ê	Ô	˘
3	♥	♠	♣	3	C	S	c	s	â	ô	ú	ú	F	È	Ò	¼
4	♦	♠	♣	4	D	T	d	t	ä	ö	ñ	ñ	-	È	ö	¶
5	♣	♣	♣	5	E	U	e	u	à	ò	Ñ	Ñ	+	Ö	Ş	§
6	♠	♠	♠	6	F	V	f	v	â	û	Ğ	ğ	+	İ	µ	÷
7	•	↕	↕	7	G	W	g	w	ç	ù	ğ	ğ	+	İ	ı	˘
8	■	↑	↑	8	H	X	h	x	é	ı	ı	ı	+	İ	ı	˘
9	○	↓	↓	9	I	Y	i	y	ë	ö	ı	ı	+	İ	ı	˘
A	☑	→	→	A	J	Z	j	z	è	ü	ı	ı	+	İ	ı	˘
B	♂	←	←	B	K	[	k	{	ı	ø	½	½	+	İ	ı	˘
C	♀	L	L	C	L	\	l		ı	£	¼	¼	+	İ	ı	˘
D	♪	↔	↔	D	=	M	]m	}	ı	Ø	i	ı	+	İ	ı	˘
E	♫	▲	▲	E	>	N	^	~	Ä	Ş	«	«	+	İ	ı	˘
F	☀	▼	▼	F	? /	O	_	o	Å	ş	»	»	+	İ	ı	˘

PC-853 Turkish (18U)

	0	1	2	3	4	5	6	7	8	9	A	B	C	D	E	F
0	▶	◀	!	"	#	\$	%	&	'	(	)	*	→	◀	♂	-
1	☺	☹	♥	♦	♣	♠	♣	♠	♣	♠	♣	♠	♣	♠	♣	♠
2	☺	☹	♥	♦	♣	♠	♣	♠	♣	♠	♣	♠	♣	♠	♣	♠
3	☺	☹	♥	♦	♣	♠	♣	♠	♣	♠	♣	♠	♣	♠	♣	♠
4	☺	☹	♥	♦	♣	♠	♣	♠	♣	♠	♣	♠	♣	♠	♣	♠
5	☺	☹	♥	♦	♣	♠	♣	♠	♣	♠	♣	♠	♣	♠	♣	♠
6	☺	☹	♥	♦	♣	♠	♣	♠	♣	♠	♣	♠	♣	♠	♣	♠
7	☺	☹	♥	♦	♣	♠	♣	♠	♣	♠	♣	♠	♣	♠	♣	♠
8	☺	☹	♥	♦	♣	♠	♣	♠	♣	♠	♣	♠	♣	♠	♣	♠
9	☺	☹	♥	♦	♣	♠	♣	♠	♣	♠	♣	♠	♣	♠	♣	♠
A	☺	☹	♥	♦	♣	♠	♣	♠	♣	♠	♣	♠	♣	♠	♣	♠
B	☺	☹	♥	♦	♣	♠	♣	♠	♣	♠	♣	♠	♣	♠	♣	♠
C	☺	☹	♥	♦	♣	♠	♣	♠	♣	♠	♣	♠	♣	♠	♣	♠
D	☺	☹	♥	♦	♣	♠	♣	♠	♣	♠	♣	♠	♣	♠	♣	♠
E	☺	☹	♥	♦	♣	♠	♣	♠	♣	♠	♣	♠	♣	♠	♣	♠
F	☺	☹	♥	♦	♣	♠	♣	♠	♣	♠	♣	♠	♣	♠	♣	♠

ISO-10646 (18N)

	0	1	2	3	4	5	6	7	8	9	A	B	C	D	E	F
0	▶	◀	!	"	#	\$	%	&	'	(	)	*	→	◀	♂	-
1	☺	☹	♥	♦	♣	♠	♣	♠	♣	♠	♣	♠	♣	♠	♣	♠
2	☺	☹	♥	♦	♣	♠	♣	♠	♣	♠	♣	♠	♣	♠	♣	♠
3	☺	☹	♥	♦	♣	♠	♣	♠	♣	♠	♣	♠	♣	♠	♣	♠
4	☺	☹	♥	♦	♣	♠	♣	♠	♣	♠	♣	♠	♣	♠	♣	♠
5	☺	☹	♥	♦	♣	♠	♣	♠	♣	♠	♣	♠	♣	♠	♣	♠
6	☺	☹	♥	♦	♣	♠	♣	♠	♣	♠	♣	♠	♣	♠	♣	♠
7	☺	☹	♥	♦	♣	♠	♣	♠	♣	♠	♣	♠	♣	♠	♣	♠
8	☺	☹	♥	♦	♣	♠	♣	♠	♣	♠	♣	♠	♣	♠	♣	♠
9	☺	☹	♥	♦	♣	♠	♣	♠	♣	♠	♣	♠	♣	♠	♣	♠
A	☺	☹	♥	♦	♣	♠	♣	♠	♣	♠	♣	♠	♣	♠	♣	♠
B	☺	☹	♥	♦	♣	♠	♣	♠	♣	♠	♣	♠	♣	♠	♣	♠
C	☺	☹	♥	♦	♣	♠	♣	♠	♣	♠	♣	♠	♣	♠	♣	♠
D	☺	☹	♥	♦	♣	♠	♣	♠	♣	♠	♣	♠	♣	♠	♣	♠
E	☺	☹	♥	♦	♣	♠	♣	♠	♣	♠	♣	♠	♣	♠	♣	♠
F	☺	☹	♥	♦	♣	♠	♣	♠	♣	♠	♣	♠	♣	♠	♣	♠

Windows Latin 1 (19U)

0	1	2	3	4	5	6	7	8	9	A	B	C	D	E	F
0	0	16	32	48	64	80	96	112	128	144	160	176	192	208	224
1	1	17	33	49	65	81	97	113	129	145	161	177	193	209	225
2	2	18	34	50	66	82	98	114	130	146	162	178	194	210	226
3	3	19	35	51	67	83	99	115	131	147	163	179	195	211	227
4	4	20	36	52	68	84	100	116	132	148	164	180	196	212	228
5	5	21	37	53	69	85	101	117	133	149	165	181	197	213	229
6	6	22	38	54	70	86	102	118	134	150	166	182	198	214	230
7	7	23	39	55	71	87	103	119	135	151	167	183	199	215	231
8	8	24	40	56	72	88	104	120	136	152	168	184	200	216	232
9	9	25	41	57	73	89	105	121	137	153	169	185	201	217	233
A	10	26	42	58	74	90	106	122	138	154	170	186	202	218	234
B	11	27	43	59	75	91	107	123	139	155	171	187	203	219	235
C	12	28	44	60	76	92	108	124	140	156	172	188	204	220	236
D	13	29	45	61	77	93	109	125	141	157	173	189	205	221	237
E	14	30	46	62	78	94	110	126	142	158	174	190	206	222	238
F	15	31	47	63	79	95	111	127	143	159	175	191	207	223	239

Winbalt (19L)

0	1	2	3	4	5	6	7	8	9	A	B	C	D	E	F
0	0	16	32	48	64	80	96	112	128	144	160	176	192	208	224
1	1	17	33	49	65	81	97	113	129	145	161	177	193	209	225
2	2	18	34	50	66	82	98	114	130	146	162	178	194	210	226
3	3	19	35	51	67	83	99	115	131	147	163	179	195	211	227
4	4	20	36	52	68	84	100	116	132	148	164	180	196	212	228
5	5	21	37	53	69	85	101	117	133	149	165	181	197	213	229
6	6	22	38	54	70	86	102	118	134	150	166	182	198	214	230
7	7	23	39	55	71	87	103	119	135	151	167	183	199	215	231
8	8	24	40	56	72	88	104	120	136	152	168	184	200	216	232
9	9	25	41	57	73	89	105	121	137	153	169	185	201	217	233
A	10	26	42	58	74	90	106	122	138	154	170	186	202	218	234
B	11	27	43	59	75	91	107	123	139	155	171	187	203	219	235
C	12	28	44	60	76	92	108	124	140	156	172	188	204	220	236
D	13	29	45	61	77	93	109	125	141	157	173	189	205	221	237
E	14	30	46	62	78	94	110	126	142	158	174	190	206	222	238
F	15	31	47	63	79	95	111	127	143	159	175	191	207	223	239

PC-861 Iceland (21U)

0	1	2	3	4	5	6	7	8	9	A	B	C	D	E	F
0	☺	▶	0	@	P	`	p	Ç	É	á	⠠	L	⊥	α	≡
1	☹	◀	1	A	Q	a	q	ü	æ	í	⠠	⊥	⊥	β	±
2	☺	↕	2	B	R	b	r	é	Æ	ó	⠠	T	⊥	Γ	≥
3	♥	!!	3	C	S	c	s	â	ô	ú		⊥	⊥	π	≤
4	♦	¶	4	D	T	d	t	ä	ö	Á	⊥	⊥	⊥	Σ	∫
5	♣	§	5	E	U	e	u	à	þ	Í	⊥	⊥	⊥	σ	∫
6	♠	—	6	F	V	f	v	á	û	Ó	⊥	⊥	⊥	μ	÷
7	●	↕	7	G	W	g	w	ç	ý	Ú	⊥	⊥	⊥	τ	≈
8	■	↑	8	H	X	h	x	ê	ý	í	⊥	⊥	⊥	Φ	°
9	○	↓	9	I	Y	i	y	ë	ö	Ö	⊥	⊥	⊥	Θ	·
A	☑	→	:	J	Z	j	z	è	ü	Ü	⊥	⊥	⊥	Ω	·
B	♂	←	;	K	[	k	{	Ð	ø	½	⊥	⊥	⊥	δ	√
C	♀	L,	<	L	\	l		Þ	ø	¼	⊥	⊥	⊥	∞	n
D	♪	↔	=	M	]m	}	}	Þ	Ø	i	⊥	⊥	⊥	φ	²
E	♫	▲	>	N	^	n	~	Ä	Þs	«	⊥	⊥	⊥	ε	▪
F	☀	▼	?	O	_	o	△	Å	f	»	⊥	⊥	⊥	∪	⊂

PC-860 Portugal (20U)

0	1	2	3	4	5	6	7	8	9	A	B	C	D	E	F
0	▶	0	@	P	`	p	ç	É	á	⠠	⠠	L	⊥	α	≡
1	◀	1	A	Q	a	q	ü	À	í	⠠	⠠	⊥	⊥	β	±
2	↕	2	B	R	b	r	é	È	ó	⠠	⠠	T	⊥	Γ	≥
3	!!	3	C	S	c	s	â	ô	ú			⊥	⊥	π	≤
4	¶	4	D	T	d	t	ä	ö	ñ	⊥	⊥	⊥	⊥	Σ	∫
5	§	5	E	U	e	u	à	ò	Ñ	⊥	⊥	⊥	⊥	σ	∫
6	—	6	F	V	f	v	á	ù	á	⊥	⊥	⊥	⊥	μ	÷
7	↕	7	G	W	g	w	ç	ù	º	⊥	⊥	⊥	⊥	τ	≈
8	↑	8	H	X	h	x	ê	ì	í	⊥	⊥	⊥	⊥	Φ	°
9	↓	9	I	Y	i	y	ë	ò	ò	⊥	⊥	⊥	⊥	Θ	·
A	☑	→	:	J	Z	j	z	è	ü	Ü	⊥	⊥	⊥	Ω	·
B	♂	←	;	K	[	k	{	Í	ç	½	⊥	⊥	⊥	δ	√
C	♀	L,	<	L	\	l		Ô	£	¼	⊥	⊥	⊥	∞	n
D	♪	↔	=	M	]m	}	}	ì	Ü	i	⊥	⊥	⊥	φ	²
E	♫	▲	>	N	^	n	~	Ã	Þs	«	⊥	⊥	⊥	ε	▪
F	☀	▼	?	O	_	o	△	Á	Ó	»	⊥	⊥	⊥	∪	⊂

PC-8 Polish (24Q)

	0	1	2	3	4	5	6	7	8	9	A	B	C	D	E	F
0	▶	◀	!	"	#	\$	%	&	'	(	)	*	→	←	↔	↕
1	☺	☹	↑	↓	↔	↕	↔	↕	↔	↕	↔	↕	↔	↕	↔	↕
2	☹	☺	↑	↓	↔	↕	↔	↕	↔	↕	↔	↕	↔	↕	↔	↕
3	♥	♠	♣	♣	♣	♣	♣	♣	♣	♣	♣	♣	♣	♣	♣	♣
4	♠	♣	♣	♣	♣	♣	♣	♣	♣	♣	♣	♣	♣	♣	♣	♣
5	♣	♣	♣	♣	♣	♣	♣	♣	♣	♣	♣	♣	♣	♣	♣	♣
6	♣	♣	♣	♣	♣	♣	♣	♣	♣	♣	♣	♣	♣	♣	♣	♣
7	♣	♣	♣	♣	♣	♣	♣	♣	♣	♣	♣	♣	♣	♣	♣	♣
8	♣	♣	♣	♣	♣	♣	♣	♣	♣	♣	♣	♣	♣	♣	♣	♣
9	♣	♣	♣	♣	♣	♣	♣	♣	♣	♣	♣	♣	♣	♣	♣	♣
A	♣	♣	♣	♣	♣	♣	♣	♣	♣	♣	♣	♣	♣	♣	♣	♣
B	♣	♣	♣	♣	♣	♣	♣	♣	♣	♣	♣	♣	♣	♣	♣	♣
C	♣	♣	♣	♣	♣	♣	♣	♣	♣	♣	♣	♣	♣	♣	♣	♣
D	♣	♣	♣	♣	♣	♣	♣	♣	♣	♣	♣	♣	♣	♣	♣	♣
E	♣	♣	♣	♣	♣	♣	♣	♣	♣	♣	♣	♣	♣	♣	♣	♣
F	♣	♣	♣	♣	♣	♣	♣	♣	♣	♣	♣	♣	♣	♣	♣	♣

PC-863 Canada (23U)

	0	1	2	3	4	5	6	7	8	9	A	B	C	D	E	F
0	▶	◀	!	"	#	\$	%	&	'	(	)	*	→	←	↔	↕
1	☺	☹	↑	↓	↔	↕	↔	↕	↔	↕	↔	↕	↔	↕	↔	↕
2	☹	☺	↑	↓	↔	↕	↔	↕	↔	↕	↔	↕	↔	↕	↔	↕
3	♥	♠	♣	♣	♣	♣	♣	♣	♣	♣	♣	♣	♣	♣	♣	♣
4	♠	♣	♣	♣	♣	♣	♣	♣	♣	♣	♣	♣	♣	♣	♣	♣
5	♣	♣	♣	♣	♣	♣	♣	♣	♣	♣	♣	♣	♣	♣	♣	♣
6	♣	♣	♣	♣	♣	♣	♣	♣	♣	♣	♣	♣	♣	♣	♣	♣
7	♣	♣	♣	♣	♣	♣	♣	♣	♣	♣	♣	♣	♣	♣	♣	♣
8	♣	♣	♣	♣	♣	♣	♣	♣	♣	♣	♣	♣	♣	♣	♣	♣
9	♣	♣	♣	♣	♣	♣	♣	♣	♣	♣	♣	♣	♣	♣	♣	♣
A	♣	♣	♣	♣	♣	♣	♣	♣	♣	♣	♣	♣	♣	♣	♣	♣
B	♣	♣	♣	♣	♣	♣	♣	♣	♣	♣	♣	♣	♣	♣	♣	♣
C	♣	♣	♣	♣	♣	♣	♣	♣	♣	♣	♣	♣	♣	♣	♣	♣
D	♣	♣	♣	♣	♣	♣	♣	♣	♣	♣	♣	♣	♣	♣	♣	♣
E	♣	♣	♣	♣	♣	♣	♣	♣	♣	♣	♣	♣	♣	♣	♣	♣
F	♣	♣	♣	♣	♣	♣	♣	♣	♣	♣	♣	♣	♣	♣	♣	♣

PC-775 (26U)

	0	1	2	3	4	5	6	7	8	9	A	B	C	D	E	F
0	▶	◀	!	"	#	\$	%	&	'	(	)	*	→	←	L	α
1	☺	☹	!	"	#	\$	%	&	'	(	)	*	→	←	L	α
2	☺	☹	"	#	\$	%	&	'	(	)	*	→	←	L	α	β ±
3	♥	♣	#	\$	%	&	'	(	)	*	→	←	L	α	β ±	Γ
4	♦	♠	\$	%	&	'	(	)	*	→	←	L	α	β ±	Γ	π
5	♣	♠	%	&	'	(	)	*	→	←	L	α	β ±	Γ	π	Σ
6	♠	♣	&	'	(	)	*	→	←	L	α	β ±	Γ	π	Σ	σ
7	●	◀	'	(	)	*	→	←	L	α	β ±	Γ	π	Σ	σ	μ
8	◻	◻	(	)	*	→	←	L	α	β ±	Γ	π	Σ	σ	μ	τ
9	○	○	)	*	→	←	L	α	β ±	Γ	π	Σ	σ	μ	τ	≈
A	◼	◼	*	→	←	L	α	β ±	Γ	π	Σ	σ	μ	τ	≈	°
B	♂	♀	→	←	L	α	β ±	Γ	π	Σ	σ	μ	τ	≈	°	Φ
C	♀	♂	←	→	L	α	β ±	Γ	π	Σ	σ	μ	τ	≈	°	Θ
D	♫	♫	→	←	L	α	β ±	Γ	π	Σ	σ	μ	τ	≈	°	Ω
E	♫	♫	←	→	L	α	β ±	Γ	π	Σ	σ	μ	τ	≈	°	δ
F	☀	☀	←	→	L	α	β ±	Γ	π	Σ	σ	μ	τ	≈	°	∞

PC-865 Norway (25U)

	0	1	2	3	4	5	6	7	8	9	A	B	C	D	E	F
0	▶	◀	!	"	#	\$	%	&	'	(	)	*	→	←	L	α
1	☺	☹	!	"	#	\$	%	&	'	(	)	*	→	←	L	α
2	☺	☹	"	#	\$	%	&	'	(	)	*	→	←	L	α	β ±
3	♥	♣	#	\$	%	&	'	(	)	*	→	←	L	α	β ±	Γ
4	♦	♠	\$	%	&	'	(	)	*	→	←	L	α	β ±	Γ	π
5	♣	♠	%	&	'	(	)	*	→	←	L	α	β ±	Γ	π	Σ
6	♠	♣	&	'	(	)	*	→	←	L	α	β ±	Γ	π	Σ	σ
7	●	◀	'	(	)	*	→	←	L	α	β ±	Γ	π	Σ	σ	μ
8	◻	◻	(	)	*	→	←	L	α	β ±	Γ	π	Σ	σ	μ	τ
9	○	○	)	*	→	←	L	α	β ±	Γ	π	Σ	σ	μ	τ	≈
A	◼	◼	*	→	←	L	α	β ±	Γ	π	Σ	σ	μ	τ	≈	°
B	♂	♀	→	←	L	α	β ±	Γ	π	Σ	σ	μ	τ	≈	°	Φ
C	♀	♂	←	→	L	α	β ±	Γ	π	Σ	σ	μ	τ	≈	°	Θ
D	♫	♫	→	←	L	α	β ±	Γ	π	Σ	σ	μ	τ	≈	°	Ω
E	♫	♫	←	→	L	α	β ±	Γ	π	Σ	σ	μ	τ	≈	°	δ
F	☀	☀	←	→	L	α	β ±	Γ	π	Σ	σ	μ	τ	≈	°	∞





## HP 7550A Emulation [KC-GL] (Mode 8)

The HP 7550A emulation applies only to the printing systems that handle A3-size paper.

The printing system emulates the Hewlett-Packard plotter model HP 7550A and uses the Kyocera Graphics Language (KC-GL). While it shares features with the HP-GL language, it is designed to provide additional features the plotter cannot give.

KC-GL uses a simple mnemonic graphic language consisting of two-letter instructions. Some typical examples are *PA* for *Plot to Absolute coordinates* and *SP* for *Select a Pen*. The KC-GL instructions are summarized at the end of this section.

To set the KC-GL for power-up emulation, send the printer the following FRPO command:

```
!R! FRPO P1, 8; EXIT;
```

The SEM (Set EMulation) 8; command temporarily switches the printer to the KC-GL emulation.

In the HP 7550A emulation the user can receive plotting status information from the printer via the RS-232C interface. Status information is not available when the parallel interface is used.

### Basic

This section explains basic information about the KC-GL language.

#### *KC-GL Instruction Format*

The syntax for KC-GL instructions consists of two letters followed by parameters (if any), then a terminator as shown below.

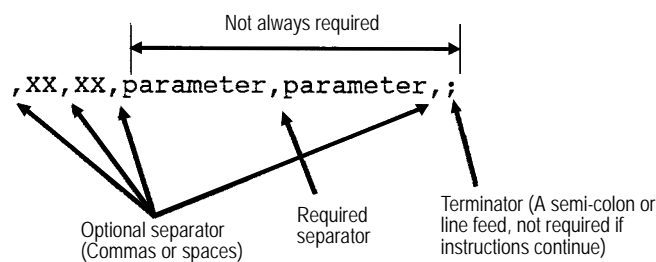

Some instructions use no parameters. For two or more parameters, they must be separated by at least one comma or space. In some cases, a plus (+) or minus (-) sign can be used as a separator. A comma or space can also be used as a separator before, after, or between instructions, and after a terminator. When a series of instructions is coded, the series should be terminated by a semicolon, but no semicolon is required between instructions in the series.

The printing system executes instructions as soon as it receives them. When too many instructions are issued, the printing system executes the allowed number of parameters and reports error number 2 (wrong number of parameters).

The SM (Symbol Mode) instruction defines the first succeeding character as a symbol character. The DT (Define label Terminator) instruction defines the first succeeding character as a character plot terminator.

The character plot terminator is used to terminate the LB (LaBel) instruction. The default terminator is the ETX character (End of Text), which uses ASCII code 3. If this terminator is inconvenient, the DT instruction enables the user to change the character plot terminator to a different character.

## Parameter Formats

KC-GL parameters are specified in one of the following formats:

### Integer

When not scaled, integers are valid in the range from  $-2^{23}$  to  $2^{23}-1$  plotter units. Digits to the right of the decimal point are ignored. If no sign is specified, the value is assumed to be positive.

### Real number (decimal)

Real numbers from  $-2^{23}$  to  $2^{23}-1$  are valid. They can include up to eight digits to the right of the decimal point. If no sign is specified, the value is assumed to be positive.

### Scaled real number (scaled decimal)

Real numbers from  $-2^{23}$  to  $2^{23}-1$  can be used with up to eight digits to the right of the decimal point. If no sign is specified, the value is assumed to be positive. Scaled real numbers are used only with scaled user units. All KC-GL parameters that are interpreted as user units are scaled.

### Character string

A combination of characters, numeric expressions, and string variables.

When coding an instruction with two or more parameters (*Examples: PA, PR, PU, PD*) remember that the parameters must be set apart by a separator.

## KC-GL Environment Options

The FRPO G0 command establishes various options for the KC-GL environment. The following table lists the meanings of the individual bits in the command. Each meaning is explained in the following sections according to the bit position.

Table 7.28. FRPO G0 Command Options

Bit Position	Bit Value	Logic Value	Description
0	0	0	Plot coordinate mode A
	1	1	Plot coordinate mode B
1	0	0	Form feed in response to SP
	2	1	SP
2	0	0	Automatic plot coordinate transition
	4	1	Fixed plot coordinate
3	0	0	Normal mode
	8	1	Enhance mode

Table 7.28. FRPO G0 Command Options

Bit Position	Bit Value	Logic Value	Description
4	0	0	Landscape page orientation
	16	1	Page orientation to FRPO C1
5	0	0	Default cursor at top left
	32	1	Default cursor at bottom left

### Plot Coordinates (bit 0)

This bit defines one of two plotting coordinate modes. (See *Figure 7. 29.* on page 98.)

0 = Mode A

1 = Mode B

In mode A, the origin (0, 0) starts at bottom left. In mode B, the origin starts at the center of the page.

### Response to SP Instruction (bit 1)

This bit defines the printing system response to the SP (Select Pen) instruction.

0 = Printing System feeds out a page when it receives a SP; or SP 0; instruction.

1 = Printing System returns the pen to the stall from which it came, in other words, it prints *nothing* when it receives a SP; or SP 0; instruction.

Figure 7. 29. Plot Coordinates

Mode A (G0, 0;)

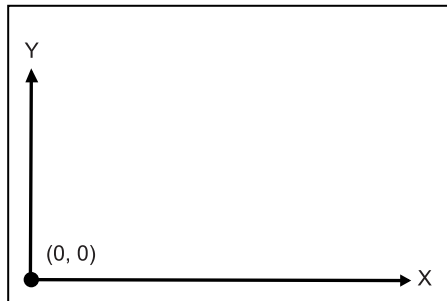

Mode B (G0, 1;)

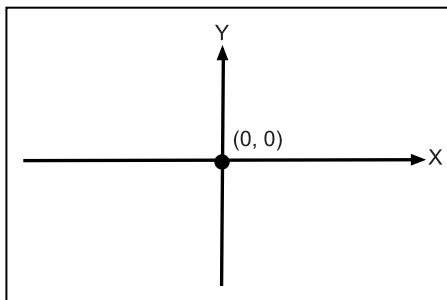

### Automatic Plot Coordinate Mode (bit 2)

0 = Printing System changes the plot coordinate from mode A to mode B when it receives a IP (Input P1 and P2) instruction using the negative parameter value. When the IN (INitalize) instruction is later given, the printing system reverts to mode A.

- 1 = Printing System remains in mode A even when the IP instruction includes a negative parameter value.

### Enhance Mode (bit 3)

This bit supports the enhance mode of HP 7550A and HP 758X plotters.

- 0 = Normal mode (HP 7550A standard mode and HP 758X emulation mode).  
 1 = Enhance mode (HP 7550A enhance mode and HP 758X standard mode).

The enhance mode should be turned on when the printing system uses the HP 758X mode. The enhance mode affects the KC-GL IW (Input Window), OW (Output Window), and UC (plot User-defined Character) instructions as follows:

IW: User units are used for specifying the parameters in scaling.

OW: Window outputs are made in user units in scaling.

UC: Values for the pen control, increments in x- and y-coordinates, the width and height of characters differ from the normal (non-enhance) mode as follows.

	Pen down	Pen up	x/y increment	Char. width	Char. Height
Normal mode	≥99	≤ -99	-98 to +98	6 grids	16 grids
Enhance mode	≥9999	≤ -9999	-9998 to +9998	48 grids	64 grids

### Page Orientation (bit 4)

This bit defines page orientation.

- 0 = Landscape  
 1 = Observes the FRPO C1 value.

### Default Cursor Position (bit 5)

This bit defines the cursor position for the page at power-up.

- 0 = Upper-left corner of the page ( $X_{\min}$ ,  $Y_{\max}$ )  
 1 = Lower-left corner of the page ( $X_{\min}$ ,  $Y_{\min}$ )

## Pen Selection

On an actual plotter, pen thickness and color are selected by physically installing pens. On the printing system, the pen thickness is established with a PRESCRIBE command, or by a simple front-panel operation.

### Format

!R! FRPO Gn, xx; EXIT;

### Parameters

*n*:

pen number:

- 1 = pen 1  
 2 = pen 2  
 3 = pen 3  
 4 = pen 4  
 5 = pen 5  
 6 = pen 6

7 = pen 7

8 = pen 8

xx:

Line-width (in dots): 0 to 99 (0 - line not printed)

Positions in the plot area can be defined as plotter units or user units. These units are explained next.



Note

Since the pen thickness is measured in the unit of dot, printing an object in the 600-dpi resolution will result in the thickness of lines being half that expected in the 300-dpi resolution. To avoid this, switch the printing resolution to 300 dpi using the FRPO N8 command or, temporarily, using the PRESCRIBE RESL command. Alternatively, if you need to use the 600-dpi resolution, increase the pen thickness to the double.

## Reducing Data Larger Than A2 Size

The KC-GL can print the data of paper sizes larger than A2 size reducing it onto a paper size specified using the SPSZ command. Reduction of data is achieved by the FRPO J9 parameter or from the printing system's control panel. See below.

### Format

```
!R! FRPO J9, x; EXIT;
```

x:

data size:

0 = no reduction

1 = A2

2 = A1

3 = A0

4 = B3

5 = B2

6 = B1

7 = B0

## Plotter Units and User Units

### Plotter Units

The plot area is subdivided into a grid with 0.025-mm steps. Each step is a plotter unit: the smallest unit of plotting motion. One millimeter corresponds to approximately 40 plotter units. In the plot area, you can specify positions in plotter units from  $-2^{23}$  to  $2^{23}-1$  (in the PA instruction). When using plotter units, only integer values are valid.

### User Units

The Scale instruction (SC) establishes a system of user units in the plot area by specifying the coordinates of two scaling points (P1 and P2). Parameters of the Scale instruction can use integer values from  $-2^{23}$  to  $2^{23}-1$ ; any digits to the right of the decimal place will be ignored. (Plot instructions use the same range of parameter values, but digits to the right of the decimal point are valid.) If designating  $0, 0$  and  $1, 1$  as scaling points, all data will be real numbers between  $0$  and  $1$ .

## Setting the Scaling Points

At power-up, scaling point *P1* will be in the lower left corner of the paper, the default plot position. Point *P2* is always diagonally opposite to *P1*. These two points define the diagonal of a rectangle, which by default is centered on the paper. *P1* and *P2* can be moved by an instruction which defines any rectangle, independent of the actual paper size.

The default positions of the scaling points in modes A and B are listed at the end of this section as *Coordinate Values*.

## Sample KC-GL Program

The following file draws circles according to the KC-GL instructions. The result appears in *Figure 7. 30.* on page 102.

```

IN;                               "Initialize plotter"
IP0,0,400,400;                     "P1 and P2: 1-cm square1"
SC0,1,0,1;                          "Scale: user unit = 1 cm"

DT ;
SP1;                               "Select pen 1"
PA10,19;                            "Move pen"
CI.1;PR0,-.1;                       "Draw four circles"
CI.2;PR0,-.2;
CI.4;PR0,-.4;
CI.8;PR0,-.8;

SP2;                               "Select pen 2"
CI1.6;PR0,-1.6;                     "Draw two circles"
CI3.2;PR0,-3.2;

SP8;                               "Select pen 8"
CI.1;PR.5,-.5;                      "Draw circle"
SP2;                               "Select pen 2"
CS0;SI.2,.3;LBCURSOR* ;           "Print label2"
SP;

```

<sup>1</sup> This instruction locates *P1* at 0, 0 and *P2* at 400, 400 in plotter units. 400 plotter units=1 cm (0.025 mm x 400).

<sup>2</sup> ETX (End of Text, character code 03) is required as a terminator.

Figure 7. 30. KC-GL Sample Program

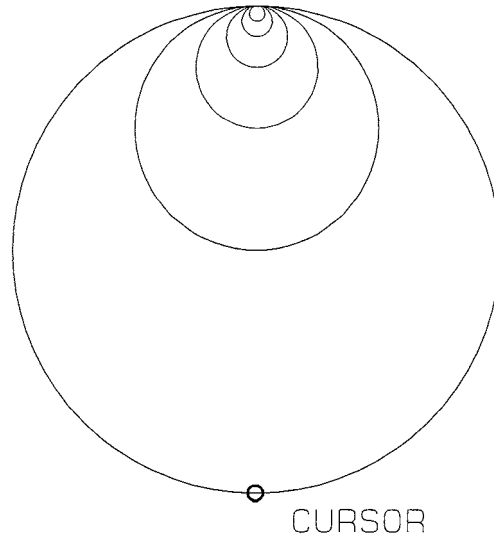

## Plotter Status Information

When the RS-232C interface is used, in addition to receiving data, the plotter (printing system) can return information such as the current pen position, pen status, and error numbers. This return information applies to the following KC-GL instructions.

Instruction	Description
OA	Output Actual position and pen status
OC	Output Commanded position and pen status
OE	Output Error
OF	Output Factors
OH	Output Hard-clip limits
OI	Output Identification
OL	Output Label length
OO	Output Options
OP	Output P1 and P2
OS	Output Status
OT	Output carousel Type
OW	Output Window

All of these instructions use the same syntax and must be followed immediately by a terminator. They use no parameters.

The functions of these instructions appear on the following pages. The last ASCII character sent by the plotter (printing system) in response to the instruction is a terminator, which will be designated here by the symbol TERM. The terminator is actually a carriage return unless changed by the ESC.M operator.



***OA [Output Actual position and pen status]***

The plotter returns the x- and y-coordinates of the current pen position and indicates whether the pen is currently up or down. This information is given by ASCII-coded integers in the following format:

X, Y, P TERM

X: x-coordinate in absolute plotter units  
 Y: y-coordinate in absolute plotter units  
 P: 0 if the pen is up; 1 if the pen is down

***OC [Output Commanded position and pen status]***

The plotter returns the x- and y-coordinates and pen status for the last valid pen positioning instruction. The pen position and status are ASCII-coded in the same way as the OA instruction. Coordinate values are given in plotter units if scaling is off, or user units if scaling is on.

***OE [Output Error]***

The plotter returns a decimal error number for the instruction executed immediately before the OE instruction. The error code is converted to a non-negative ASCII-coded integer whose identity is given in the following table.

Error Number	Description
0	No error
1	Instruction not recognized
2	Wrong number of parameters
3	Illegal parameter
4	(Reserved)
5	Unknown character set
6	Plot position overflow
7	(Reserved)

***OF [Output Factors]***

This instruction returns the number of plotter units per millimeter on each coordinate axis, as follows:

40, 40 TERM

This response indicates that plotter units are equal to 0.025 mm on both the x- and y-axes. The actual number of plotter units per millimeter is approximately 40.

***OH [Output Hard-clip limits]***

This instruction returns the lower left and upper right limiting coordinates of the plot area, in the following format:

X<sub>LL</sub>, Y<sub>LL</sub>, X<sub>UR</sub>, Y<sub>UR</sub> TERM

LL: lower left  
 UR: upper right

### *OI [Output Identification]*

This instruction returns a character string indicating the plotter model being emulated, as follows:

```
KC-GL option Plotter model
(FRPO G0)
Mode A      7550A TERM
Mode B      7596A TERM
```

### *OL [Output Label length]*

This instruction returns information on the contents of the label buffer. This may be used together with the BL instruction for accessing the necessary space for the buffered label before printing it.

```
length, characters, linefeeds, TERM
```

*length* The length of the longest line in the buffered label in character plot cell spaces.

*characters* An integer representing the number of printing characters and spaces in the longest line of the buffered label. A backspace is counted as -1, whereas a character with automatic backspace counts as zero.

*linefeeds* An integer representing the net number of linefeeds that will occur when the buffered label is drawn. An inversed line feed (VT) counts as -1, and a line-feed (LF) counts as +1.

### *OO [Output Options]*

This instruction returns eight ASCII-coded integers separated by commas. The integers indicate plotter options supported by the printing system, as follows:

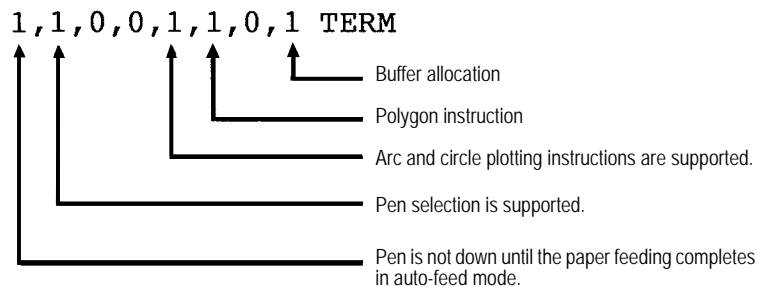

### *OP [Output P1 and P2]*

This instruction returns the coordinate values of the current scaling points P1 and P2. The coordinates are given in plotter units by ASCII-coded integers, as follows:

```
P1x, P1y, P2x, P2y TERM
```

## OS [Output Status]

This instruction returns an integer from 0 to 255 giving one byte of status information, as follows:

```
status TERM
```

The following table describes the individual bits in the status byte. After powered up or an IN instruction, bit positions 3 and 4 turn on making the bit value to be 24. Bit position 3 is cleared subsequently after delivering the status.

Bit Position	Bit Value	Description
0	1	The pen is down.
1	2	P1 or P2 has been changed. This bit is cleared when actual P1 and P2 values are read via the RS-232C interface, or when the IN instruction is executed.
2	4	A digitized point is ready for output. This bit is cleared when the point is output via the RS-232C interface, or when the IN instruction is executed.
3	8	Initialized. This bit is cleared when a status byte is output via the RS-232C interface, or when the IN instruction is executed.
4	16	Ready to receive next data.
5	32	Error. This bit is cleared when an error number is output via the RS-232C interface, or when the IN instruction is executed.
6	64	SRQ was set.
7	128	(Reserved)

## OT [Output carousel Type]

This instruction delivers information on the current carousel type and stall occupancy. This may be used to determine those information in a remote location.

```
OT TERM
```

*Response:*

```
type, map TERM
```

The current carousel type and its pen map are delivered as 2 ASCII integers, each separated by comma. The type field can contain the values -1 through 4, which have the following values:

Bit value when stall is occupied	Pen stall
1	1
2	2
4	3
8	4
16	5
32	6
64	7
128	8

### *OW [Output Window]*

This instruction returns the x- and y-coordinates of two diagonally opposite corners of the current plottable area. Four ASCII-coded integers indicating the lower left and upper right corner coordinates are returned by using the following format:

X<sub>LL</sub>, Y<sub>LL</sub>, X<sub>UR</sub>, Y<sub>UR</sub>, TERM

LL: lower left

UR: upper right

## Device-Control Instructions

KC-GL uses device-control instructions to return buffer status information and other status information from the printing system via the RS-232C interface. Status information cannot be output on the parallel interface. If device-control instructions are received via the parallel interface, they are ignored.

The device-control instructions for status output appear below.

### *Output Buffer Space (ESC.B)*

This instruction returns 0 if the receive buffer is full, and 1024 if the receive buffer is empty.

### *Output Extended Error (ESC.E)*

This instruction normally returns 0, if an error has not occurred, and returns 15 if a framing error, parity error, or overrun error has occurred.

### *Output Buffer Size Label (ESC.L)*

This instruction always returns the value 1024.

### *Output Extended Status (ESC.O)*

This instruction returns printing system status information regarding:

- On-line status
- Cover open
- Paper empty
- Paper jam
- Buffer full

The following table describes this status information. The paper feed source is the internal cassette at all time. A complete list of device-control instructions appear in *Device-Control Instructions* on page 113.

*Table 7.31. Status Information*

Response	Description
1	The buffer is full.
9	The buffer is empty (normal).
17	The buffer is full and the printing system is off-line.

Table 7.31. Status Information

Response	Description
25	The buffer is empty and the printing system is off-line.
33	The buffer is full with the printing system under one of the following conditions: cover open, paper empty, or paper jam.
41	The buffer is empty with the printing system under one of the following conditions: cover open, paper empty, or paper jam.

## Fonts and Symbol Sets in KC-GL

KC-GL uses a special stroke font. The fonts employed in the other emulations cannot be used in KC-GL. The default height and width of the stroke font vary depending on the paper size. The following character sets are available for the KC-GL emulation.

Table 7.32. KC-GL Fonts and Symbol Sets

No.	Symbol Set	ISO No.
0/10	ANSI ASCII	006
1/11	HP 9825 Character Set	–
2/12	French/German	–
3/13	Scandinavian	–
4/14	Spanish/Latin American	–
6/16	JIS ASCII	014
7/17	Roman Extensions	–
8/18	Katakana	013
9/19	ISO IRV (International Reference Version)	002
30/40	ISO Swedish	010
31/41	ISO Swedish For Names	011
32/42	ISO Norwegian Version 1	060
33/43	ISO German	021
34/44	ISO French	025
35/45	ISO United Kingdom	004
36/46	ISO Italian	015
37/47	ISO Spanish	017
38/48	ISO Portuguese	016
39/49	ISO Norwegian Version 2	061

### KC-GL Symbol Sets

#### ANSI ASCII (0)

		CODE SET 0																																																																																																														
		20	30	40	50	60	70																																																																																																									
0			@	P	Q	‘	p	1	!	1	A	Q	a	q	2	"	2	B	R	b	r	3	#	3	C	S	c	s	4	\$	4	D	T	d	t	5	%	5	E	U	e	u	6	&	6	F	V	f	v	7	'	7	G	W	g	w	8	(	8	H	X	h	x	9	)	9	I	Y	i	y	A	*	:	J	Z	j	z	B	+	;	K	[	k	{	C	,	<	L	\	l		D	-	=	M	]	m	}	E	.	>	N	^	n	~	F	/	?	O	_	o	

### Roman Extensions (7)

		CODE SET 7																																																																																																																																	
		20	30	40	50	60	70																																																																																																																												
0			—	â	Å	À	Ā	1	Á	â	î	Ë	À	Ā	À	Ā	2	À	â	ø	∅	ä	ð	ä	ð	ä	ð	3	°	û	Æ	∅	∅	∅	∅	4	á	é	å	å	í	í	í	5	é	ó	í	í	í	í	í	6	ó	ú	ø	æ	ò	ò	ò	7	ú	á	æ	:Å	ó	ó	ó	8	á	é	í	:Å	ó	ó	ó	9	é	ó	í	:Å	ó	ó	ó	A	ó	ú	:Ö	:Ö	:Ö	:Ö	:Ö	B	:ö	:ö	:ö	:ö	:ö	:ö	:ö	C	:ë	:ë	:ë	:ë	:ë	:ë	:ë	D	:ë	:ë	:ë	:ë	:ë	:ë	:ë	E	:ö	:ö	:ö	:ö	:ö	:ö	:ö	F	£	£	£	£	£	£	£

Katakana (8)

CODE SET 8		20	30	40	50	60	70
0		一	ア	イ	ウ	エ	オ
1	。	「	」	、	。	ヲ	ニ
2	カ	キ	ク	ケ	コ	サ	シ
3	ソ	ス	セ	ソ	シ	ス	セ
4	。	ツ	テ	ト	チ	ニ	ヨ
5		ユ	ヨ	ラ	リ	ル	レ
6		ロ	リ	ル	レ	ヲ	ニ
7		。	。	。	。	。	。
8							
9							
A							
B							
C							
D							
E							
F							

KC-GL International Characters

	23	24	40	5B	5C	5D	5E	60	7B	7C	7D	7E
0												
1	ANSI ASCII	#	@	[	\	] ]	^	`	{		}	~
2	9825 Character Set	#	@	[	√	] ]	↑	`	π	†	→	~
3	French/German	£	@	[	ç	] ]	◊	`	°	°	°	°
4	Scandinavian	£	@	∅	Æ	∅	æ	`	°	°	°	°
5	Spanish/Latin American	¿	@	[	i	] ]	◊	`	°	°	°	°
6	JIS ASCII	#	@	[	¥	] ]	◊	`	{		}	~
7	ISO 104 (International Reference Version)	#	@	[	\	] ]	◊	`	{		}	~
8	ISO Swedish	#	@	Ä	Ö	Å	Ä	`	ä	ö	å	ü
9	ISO Swedish For Names	#	@	É	Ä	Å	Ä	`	é	ä	å	ü
10	ISO Norway, Version 1	#	@	Æ	Ø	Å	Æ	`	æ	ø	å	ü
11	ISO German	#	§	§	Ä	Ü	Ä	`	ä	ü	ü	ü
12	ISO French	£	§	à	°	§	à	`	é	é	é	é
13	ISO United Kingdom	£	§	£	£	£	£	`	£	£	£	£
14	ISO Italian	£	§	§	°	é	é	`	ú	ó	é	í
15	ISO Spanish	£	§	§	i	¿	¿	`	°	ñ	ç	ç
16	ISO Portuguese	#	§	§	ã	ç	ã	`	ã	ç	ç	ç
17	ISO Norway, Version 2	§	§	∅	Æ	∅	∅	`	æ	∅	∅	∅

Back Space Character

## KC-GL Limits

This section provides limit values for the various KC-GL parameters. Plotter units are used unless otherwise specified.

### Standard Character Sizes

*Table 7.33. Standard Character Sizes*

Paper size	Width (mm)	Height (mm)
A4	0.187	0.269
A3	0.285	0.375
Letter	0.187	0.269
Ledger	0.285	0.375

### Maximum Plot Area

*Table 7.34. Maximum Plot Area*

Paper size	X		Y	
	Plotter units	Dots	Plotter units	Dots
A4	11477	3389	7999	2362
A3	16398	4842	11487	3392
Letter	10776	3182	8236	2432
Ledger	16872	4982	10776	3182

### Coordinate Values

*Table 7.35. Coordinate Values, Mode A, RO 0*

Paper size	P1x	P1y	P2x	P2y
A4	430,	200	10430,	7400
A3	380,	430	15580,	10430
Letter	80,	320	10080,	7520
Ledger	620,	80	15820,	10080

*Table 7.36. Coordinate Values, Mode A, RO 90*

Paper size	P1x	P1y	P2x	P2y
A4	200,	430	7400,	10430
A3	430,	380	10430,	15580
Letter	320,	80	7520,	10080
Ledger	80,	620	10080,	15820

*Table 7.37. Coordinate Values, Mode B, RO 0*

Paper size	P1x	P1y	P2x	P2y
A4	-4700,	-2480	4700,	2480
A3	-6680,	-4700	6680,	4700
Letter	-4348,	-2598	4348,	2598
Ledger	-6916,	-4348	6916,	4348



## Coordinate Values, Mode B, RO 90

Paper size	P1x	P1y	P2x	P2y
A4	-2480,	-4700	2480,	4700
A3	-4700,	-6680	4700,	6680
Letter	-2598,	-4348	2598,	4348
Ledger	-4348,	-6916	4348,	6916

## Summary of KC-GL Instructions

The table below lists KC-GL instructions supported by the printing system. The following legend is used:

[c] Character string

[d] decimal (-128.0000 to +127.9999)

[i] integer (-32768 to +32767)

[sd] scaled decimal (-32768.0000 to +32767.9999)

Table 7.38. KC-GL Instructions (Sheet 1 of 2)

Instruction	Parameters	Description
AA	x-coordinate [i/sd], y-coordinate [i/sd], center-angle [i] (, resolution [i])	Arc absolute
AF	–	Advance page
AH	–	Advance page
AR	$\Delta x$ [i/sd], $\Delta y$ [i/sd], arc-angle [i] (, resolution [i])	Arc relative
BL	character-string [c] terminator	Buffer label
CA	character-set-no. [i]	Designate alternate character set
CI	radius [i/sd] (, resolution [i])	Circle
CP	horizontal-character-count [d], vertical-character-count [d]	Character plot
CS	character-set-no. [i]	Designate standard character set
CT	–	Chord tolerance for AA, AR, CI
DF	–	Default
DI	run [d], rise [d]	Absolute direction
DR	run [d], rise [d]	Relative direction
DT	terminator [c]	Define label terminator
EA	x-coordinate [i/sd], y-coordinate [i/sd]	Edge rectangle absolute
EP	–	Edge polygon for PM, RA, RR, WG
ER	$\Delta x$ [i/sd], $\Delta y$ [i/sd]	Edge rectangle relative
ES	character-space [d](, line-space [d])	Extra space for NCP
EW	radius [i/sd], start-angle [i], center-angle [i] (, resolution [i])	Edge wedge
FP	–	Fill polygon for PM, RA, RR, WG
FT	type [i] (,spacing [sd] (,angle [i]))	Fill type
IM	E-mask-value [i] (, S-mask-value [i] (,P-mask-value [i]))	Input mask
IN	–	Initialize
IP	P1x [i], P1y [i] (, P2x [i], P2y [i])	Input P1 and P2
IW	$X_{LL}$ [i/sd], $Y_{LL}$ [i/sd], $X_{UR}$ [i/sd], $Y_{UR}$ [i/sd],	Input window
LB	character-string [c]	Label
LO	position-number [i]	Label origin
LT	pattern-no. [i] (, pattern-length [d])	Line type
OA	–	Output actual position and pen status*

Table 7.38. KC-GL Instructions (Sheet 2 of 2)

Instruction	Parameters	Description
OC	–	Output commanded position and pen status*
OE	–	Output error*
OF	–	Output factors*
OH	–	Output hard-clip limits*
OI	–	Output identification*
OL	–	Output label length
OO	–	Output options*
OP	–	Output P1 and P2*
OS	–	Output status byte*
OT	–	Output carousel type
OW	–	Output window*
PA	x1-coordinate [i/sd], y1-coordinate [i/sd] (,x2-coordinate [i/sd], y2-coordinate [i/sd], ..., xn-coordinate [i/sd], yn-coordinate [i/sd])	Plot absolute
PB	–	Print buffered label
PD	x1-coordinate [i/sd], y1-coordinate [i/sd] (, ... xn-coordinate [i/sd], yn-coordinate [i/sd])	Pen down
PM	–	Polygon mode
PR	$\Delta x1$ [i/sd], $\Delta y1$ [i/sd] (, $\Delta x2$ [i/sd], $\Delta y2$ [i/sd], ..., xn-coordinate [i/sd], yn-coordinate [i/sd])	Plot relative
PS	paper-size [i]	Select paper size
PT	pen-thickness [d]	Pen thickness
PU	x1-coordinate [i/sd], y1-coordinate [i/sd] (, ... xn-coordinate [i/sd], yn-coordinate [i/sd])	Pen up
RA	x-coordinate [i/sd], y-coordinate [i/sd]	Fill rectangle absolute
RO	angle-in-degrees [i]	Rotate coordinate system
RR	$\Delta x$ [i/sd], $\Delta y$ [i/sd]	Fill rectangle relative
SA	–	Select alternate character set
SC	Xmin [i], Xmax [i], Ymin [i], Ymax [i],	Scale
SI	character-width [d], character-height [d]	Absolute character size
SL	tan $\theta$ [d]	Character slant
SM	character [c]	Symbol mode
SP	pen-number [i]	Select pen
SR	character-width [d], character-height [d]	Relative character size
SS	–	Select standard character set
TL	tick-length-in-positive-direction [d] (, tick-length-in-negative-direction [d])	Tick length
UC	(pen-control [i],) $\Delta x$ [i], $\Delta y$ (,...) (, pen-control [i]) (,...)	Plot user-defined character
WG	radius [i/sd], start-angle [i], center-angle [i] (, resolution [i])	Plot filled wedge
XT	–	X-tick
YT	–	Y-tick

### E-Mask Bit Values

The IM instruction sets an E-mask that controls how errors are reported on the RS-232C interface. The E-mask value is the sum of the bit values in the following table.

Table 7.39. E-Mask Bit Values

Bit Error No.	Description
1 0 1	Command not recognized
2 1 2	Wrong number of parameters

Table 7.39. E-Mask Bit Values

Bit Error No.	Description		
4	2	3	Illegal parameter
8	3	4	Unknown character
16	4	5	Unknown character set
32	5	6	Plot position overflow
64	6	7	-
128	7	8	-

### S-Mask/P-Mask Values

Table 7.40. S-Mask/P-Mask Values

S-Mask/P-Mask Values	Bit Value	Description
1	0	Pen down
2	1	Changed P1 or P2
4	2	Valid digitizing point
8	3	Initialized
16	4	Ready
32	5	Error
64	6	-
128	7	-

### Device-Control Instructions

Table 7.41. Device-Control Instructions

Instruction	Parameters	Description
ESC.(	-	Plotter ON <sup>a</sup>
ESC.Y	-	Plotter ON <sup>a</sup>
ESC.)	-	Plotter OFF <sup>a</sup>
ESC.Z	-	Plotter OFF <sup>a</sup>
ESC.@	[(<DEC>);(<DEC>)];	Plotter configuration <sup>a</sup>
ESC.B	-	Output buffer space
ESC.E	-	Output extended error
ESC.H	[(<DEC>);(<ASC>); (<ASC>); (;...<ASC>)]	Select handshaking mode 1 <sup>a</sup>
ESC.I	[(<DEC>);(<ASC>); (<ASC>); (;...<ASC>)]	Select handshaking mode 2 <sup>a</sup>
ESC.J	-	Ignore device-control instructions <sup>a</sup>
ESC.K	-	Ignore plot instructions <sup>a</sup>
ESC.L	-	Output buffer size
ESC.M	[(<DEC>);(<ASC>); (<ASC>); (<ASC>);(<ASC>); (<ASC>)]	Select output mode (output trigger character, echo terminator, output terminator)
ESC.N	[(<DEC>);(<ASC>); (;...<ASC>)]	Select extended output and handshaking mode 1 <sup>a</sup>
ESC.O	-	Output extended status
ESC.R	-	Reset handshaking <sup>a</sup>

<sup>a</sup> Ignored

## Default States (DF)

Table 7.42. Default States (DF)

Function	Equivalent Instruction	Default Value
Plotting mode	PA;	Absolute (plotter units)
Polygon mode	PM0; PM2;	Empty polygon
Line type	LT;	Solid line
Line pattern length	LTn,4;	4% of distance between P1 and P2
Scaling	SC;	Off (plotter units used for x- and y-coordinates)
Input window	IW;	Set to hard-clip limits
Circle and arc resolution	–	5 degrees
Symbol mode	SM;	Off
Tick length	TL;	x-axis: 0.5 % of $ P2y - P1y $ y-axis: 0.5% of $ P2x - P1x $
Mask value	IM233,0,0;	All errors recognized, but no response to service request or parallel port.
Fill type	FT;	Type 1 (bidirectional fill)
Fill spacing	FT;	1% of distance between P1 and P2 (used only in fill types 3 and 4)
Fill angle	FT;	0 degrees
Pen thickness	PT;	0.3 mm (fill spacing for fill types 1 and 2)
Label origin	–	Current pen position
Relative direction	DR1,0;	Horizontal characters
Relative size	SR;	Character width: 0.75% of $ P2x - P1x $ Character height: 1.5% of $ P2y - P1y $
Character space	ES 0, 0;	None
Character slant	SL;	0 degrees
Label buffer	BL ETX;	None
Label terminator	DT ETX;	ETX (ASCII code 3)
Label origin	LO;	Position number
Character set	SS;	Standard character set
Standard character set	CS0;	Character set 0
Code tolerance	CT;	Angle mode of AA, AR, CI, or WG
Alternate character set	CA0;	Character set 0

## Initial Conditions (IN)

Table 7.43. Initial Conditions (IN)

Function	Equivalent instruction	Initial condition
Default conditions	DF;	Default values
Scaling points	IP;	Initialized according to paper size
Coordinate system rotation	RO;	0 degrees (default setting)

# KPD L Operators

This section describes the machine-independent part of KPD L, Kyocera's implementation of the PostScript command language. KPD L deployed in the printing system encompasses the features of LanguageLevel 3 of the PostScript command language.

The KPD L operators described in this section can be used for confirming and changing the printing system's internal settings. Most of the operators in this section are paired: one operator for setting an environmental parameter, and another operator for confirming the setting. The setting operator starts with the letters *set*. The confirmation operator has the same name, but without the initial *set*.

## Communication with the Printing System

The operations described below are performed by sending KPD L operators to the printing system in the KPD L mode. KPD L operators can be sent either by file transfer, or interactively using communications software. This section explains both methods. As an example, it uses the KPD L operator that sets the printing system to print a simple graphics sample as shown in *Figure 7. 44.* on page 116.

*Example:*

Operators to draw a text and an enclosing box. Note that, in KPD L mode, unit for distances is  $1/72$  inches.

```

!R! SEM 9; EXIT;           % Enter KPD L mode
%!
3 setlinewidth            % Set line width to 3
30 30 moveto              % Move to (30 30)
0 60 rlineto              % Draw line 60 above
225 0 rlineto             % Draw line 225 to the right
0 -60 rlineto             % Draw line 60 below
closepath                 % Close the above path
gsave                     % Save current graphics state
0.6 setgray               % Set gray level to 0.6
fill                       % Fill the path with gray
grestore                  % Restore saved graphics state
0 setgray                 % Set gray level to 0
stroke                    % Stroke the path
1 setgray                 % Set gray level to solid black
/Helvetica-Nr 30 selectfont % Select and scale to 30 points
100 100 moveto            % Move to (100 100)
(Have a nice day!) show   % Print the string
showpage                  % Print the above on page
^D                         % End of job (control-D)

```

The initial SEM 9; ensures that the printing system is in the KPD L mode. If the printing system is already in the KPD L mode, SEM 9; is ignored. The percent signs (%) and the words to the right are comments. Comments are included only to explain the operators, and can be omitted when typing operators.

Try using one of the methods explained on the following page to enable delivery of the result of the above example. The print result appears as shown in *Figure 7. 44.* on page 116.

Figure 7. 44. Sample Printout

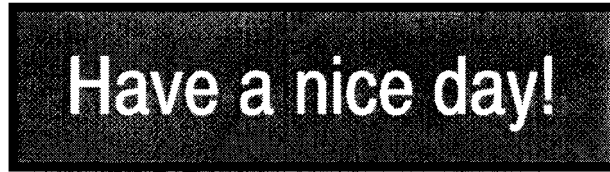

### File transfer

One way to transfer a file is to place all lines above in a file and transfer the file to the printing system. The basic requirements are:

- Except for SEM 9; and EXIT; (which can be in either uppercase or lowercase letters), all operators must be typed in lowercase letters, exactly as shown.
- The file must not contain any extraneous control codes, as are frequently added by word-processing software.
- The file must be sent as a file, not printed. If you print the file, you will only obtain printed output.

## KPDL Summary

This section lists all KPDL operators, their operands, and their results.

When received from the computer, operators and operands are placed in an area in the printing system's memory called the *stack*. In the operator table, each operator is preceded by its list of operands (if any). These operands must be placed onto the stack prior to the operator itself. Each operator is followed by a list of its results (if any). The results returned by the operator are also placed onto the stack.

For example, the add operator is listed as follows:

```
num1 num2 add sum          add num1 and num2
```

The action of this operator is to remove the two numbers that precede it from the top of the stack, add them, and put their sum onto the stack.

If an operator does not require any preceding operands or does not place any result on the stack, the corresponding column in the table is blank.

The following abbreviations (and a few others) are used for operands:

<i>ang</i>	angle (specified in degrees)
<i>bool</i>	boolean: the value true or false
<i>dict</i>	dictionary
<i>int</i>	integer
<i>num</i>	number (integer or real)
<i>obj</i>	object (any object)
<i>pattern</i>	pattern dictionary
<i>proc</i>	procedure
<i>tag</i>	tag
<i>userpath</i>	array of path construction operators and their operands



Note

Certain operators are hyphenated in the following tables because of the editorial limitation only. These operators must not be hyphenated to be executed.

## KPDFL Page Description Operators

The following table summarizes the page description operators including all language levels of KPDFL. In the following table, operators having the higher language level are indicated by ② (level 2) or ③ (level 3)

Table 7.45. KPDFL Page Description Operators (Sheet 1 of 11)

Preceding stack	Operator	Result	Description
obj	=		Write object to standard output
	=print		
	=string		
obj	==		Write object to standard output with syntax markings
	② <<	mark	Push mark object on operand stack
mark key1 value1 ...keyn valuen	② >>	dict	Create a dictionary containing the specified key-value pair
	[	mark	Push mark on stack
mark obj0...obj (n-1)	]	array	End array starting at topmost mark
num1	abs	num2	Get absolute value of num1
num1 num2	add	sum	Add num1 and num2
array	aload	a0...a(n-1) array	Load array elements into stack, below array
string target	anchorsearch	tail target true or string false	Test whether target is initial substring of string
int/bool1 int/bool2	and	int/bool3	Bitwise or logical AND
x y r ang1 ang2	arc		Create counterclockwise arc
x y r ang1 ang2	arcn		Create clockwise arc
x1 y1 x2 y2 r	② arct		Create line ending in arc
x1 y1 x2 y2 r	arcto	xt1 yt1 xt2 yt2	Create line ending in arc; return arc coordinates
int	array	array	Create array of null objects
ax ay string	ashow		Print string with adjusted character spacing
obj0...obj (n-1) array	astore	array	Pop elements from stack into array
num den	atan	angle	Get arctangent of num/den in degrees
cx cy chr ax ay string	awidthshow		Print string with ashow and widthshow effects
dict	begin		Push dict on dictionary stack
proc	bind	proc	Replace operator names in proc by values
int1 count	bitshift	int2	Shift int1 bitwise by count (positive is left)
file	bytesavailable	int	Get number of bytes left to read in file
	cachestatus	bsize bmax msize mmax csize cmax blimit	Get font cache information
num1	ceiling	num2	Find least integer not less than num1
string bool	charpath		Create character outline
	clear		Clear entire stack
	cleardictstack		Clear dictionary stack

Table 7.45. KPD L Page Description Operators (Sheet 2 of 11)

Preceding stack	Operator	Result	Description
mark obj1...objn	cleartomark		Clear stack down through mark
	clip		Create new clipping path
	clippath		Set current path as clipping path
	③ cliprestore		Restore stored clipping path
	③ clipsave		Copy and save the current clipping path
file	closefile		Close file
	closepath		Connect subpath to starting point
width height bits/comp matrix datasrc0 ... datasrcn-1 multi ncomp	colorimage		Paint a sample image
key name array key string array key dict array	③ composefont	font	Refers CIF font specified in the second CMap object or array and compose CIF font dictionary
matrix	concat		Multiply current transform matrix by given matrix
matrix1 matrix2 matrix3	concatmatrix	matrix3	Replace matrix3 with matrix1 x matrix2
obj1...objn n	copy	obj1...objn	Duplicate top n objects on stack
dict1 dict2	copy	dict2	Copy dict1 to dict2
array1 array2	copy	subarray2	Copy array1 to initial subarray of array2
string1 string2	copy	substring2	Copy string1 to initial substring of string2
gstate1 gstate2	copy		Copy gstate1 to gstate2
	copypage		Print and retain current page
angle	cos	real	Find cosine of angle (degrees)
	count	n	Count objects on stack
	countdictstack	int	Count objects on dictionary stack
	countexecstack	int	Count objects on execution stack
mark obj1...objn	counttomark	mark obj1... obj n	Count objects on stack down to mark
proc string	② cshow		Show characters changing the font mapping algorithm
	② currentblackgeneration	proc	Return the black generation function
	② currentcacheparams	mark size lower upper	Return font cache parameters
	② currentcmymkcolor	cyan magenta yellow black	Return the current color according to the cyan-magenta-yellow-black color space
	② currentcolor	comp1 comp2 ... comp n	Return the components of the color
	② currentcolorrendering	dict	Return the value of the CIE based color rendering dictionary
	② currentcolorscreen	redfreq redang redproc greenfreq greenang greenproc bluefreq blueang blueproc grayfreq grayang grayproc	Return the current halftone screen parameters
	② currentcolorspace	array	Return the color space
	② currentcolortransfer	redproc greenproc blueproc grayproc	Return the current transfer functions
	currentdash	array offset	Get current dash pattern
string	② currentdevparams	dict	Return all parameters for device



Table 7.45. KPDFL Page Description Operators (Sheet 3 of 11)

Preceding stack	Operator	Result	Description
	currentdict	dict	Push current dictionary on operand stack
	currentfile	file	Get file currently being executed
	currentflat	num	Get current flatness tolerance
	currentfont	font	Get current font dictionary
	② currentglobal	bool	Return the VM allocation mode currently in effect
	currentgray	num	Get current gray level
gstate	② currentgstate	gstate	Copy the current graphics state
	② currenthalftone	halftone	Return the current halftone dictionary
	currenthsbcolor	hue sat brt	Get current hue, saturation, and brightness
	currentlinecap	int	Get current line end type
	currentlinejoin	int	Get current corner type
	currentlinewidth	num	Get current line width
matrix	currentmatrix	matrix	Replace matrix with current transform matrix
	currentmiterlimit	num	Get current miter length limit
	② currentobjectformat	int	Return the object format parameter currently in effect
	② currentoverprint	bool	Return the value of the overprint parameter
	② currentpacking	bool	Return the current array packing mode
	② currentpagedevice	dict	Return a device parameter on the current page
	currentpoint	x y	Get coordinates of current point
	currentrgbcolor	red green blue	Get current red/green/blue levels
	currentscreen	freq angle proc	Get current halftone screen
	currentshared		Return the current stroke adjust parameter
	③ currentsmoothness	num	Returns the current arc smoothness
	② currentstrokeadjust	bool	Return the current stroke adjust parameter
	② currentsystemparams	dict	Return current values of all system parameters
	currenttransfer	proc	Get current gray transfer function
	② currentundercolorremoval	proc	Return the under color removal function
	② currentuser params	dict	Return current values of all user parameters
x1 y1 x2 y2 x3 y3	curveto		Create Bézier cubic curve from current point to (x3, y3)
num/string	cvi	int	Convert number or string to integer
obj	cvlit	obj	Convert object to literal
string	cvn	name	Convert string to name
num/string	cvr	real	Convert number or string to real
num radix string	cvrs	substring	Convert number to representation in radix
obj string	cvs	substring	Convert object to substring of string
obj	cvx	obj	Convert object to executable object
key value	def		Place key and value in current dictionary

Table 7.45. KPDL Page Description Operators (Sheet 4 of 11)

Preceding stack	Operator	Result	Description
matrix	defaultmatrix	matrix	Replace matrix with device default matrix
key font	definefont	font	Define font as a font dictionary associated with key
key instance category	② defineresource	instance	Define a resource in a specified category
index any	② defineuserobject		Establish a user object
filename	② deletefile		Remove the specified file
int	dict	dict	Create dictionary with capacity for <i>int</i> entries
array	dictstack	subarray	Copy dictionary stack to array
num1 num2	div	quotient	Divide <i>num1</i> by <i>num2</i>
dx dy	dtransform	dx' dy'	Transform distance from user to device space
dx dy matrix	dtransform	dx' dy'	Transform distance by matrix
obj	dup	obj obj	Duplicate top object on stack
bool	echo		Turn interactive echoing on/off
	end		Pop dictionary stack
	eoclip		Clip using even-odd rule
	eofill		Fill using even-odd rule
any1 any2	eq	bool	Pop two objects from the stack and pushes the boolean value true if they are equal, false if not
	erasepage		Erase the current page
obj1 obj2	exch	obj2 obj1	Exchange top two objects on stack
obj	exec		Execute preceding object
form	② execform		Paint a form
array	execstack	subarray	Copy execution stack into array
index	② execuserobject		Execute the user object
array/file/string	executeonly	array/file/string	Enable execution access only
	exit		Exit innermost loop
base exponent	exp	real	Raise base to exponent
	false	false	Push boolean value false on stack
string1 string2	file	file	Open file named string1 in string2 access mode
template proc scratch	② filenameforall		Enumerate all files whose names match
file	② fileposition	position	Return the current position in a file
	fill		Fill current path with current color
src tgt param1...paramn name	② filter	file	Create a filtered file
name string	③ findcolorrendering	name bool	Find the color rendering resource as specified by argument
key	② findencoding	array	Obtain an encoding vector
key	findfont	font	Get a font dictionary identified by key
key category	② findresource	instance	Obtain a named resource instance in a specified category
	flattenpath		Convert curves to piecewise linear segments
num1	floor	num2	Find greatest integer not exceeding num1
	flush		Send data in buffer to standard output
file	flushfile		Send data in buffer to output file, or read and discard rest of input file

Table 7.45. KPDFL Page Description Operators (Sheet 5 of 11)

Preceding stack	Operator	Result	Description
	FontDirectory	dict	Push directory of font dictionaries on stack
init incr limit proc	for		Execute <i>proc</i> for <i>init</i> to <i>limit</i> in steps of <i>incr</i>
array proc	forall		Do proc for each array element
dict proc	forall		Do proc for each element of dict
string proc	forall		Do proc for each element of string
any	Ⓢ gcheck	bool	Return residence mode of any
num/string1 num/string2	ge	bool	Test whether num/string1 is greater than or equal to num/string2
array index	get	obj	Get array element at index location
dict key	get	obj	Get value associated with key in dictionary
string index	get	int	Get string element at index location
string index count	getinterval	substring	Get substring. Index and count are starting location and length of substring
array index count	getinterval	subarray	Get subarray. Index and count are starting element and length of subarray
	Ⓢ globaldict	dict	Create a new dictionary object
	Ⓢ GlobalFontDirectory	dict	Push a dictionary of defined font
name	Ⓢ glyphshow		Show a single character
	grestore		Restore saved graphics state
	grestoreall		Restore to bottommost graphics state
	gsave		Save graphics state
	Ⓢ gstate	gstate	Create a new graphics state object
num/string1 num/string2	gt	bool	Test whether num/string1 > num/string2
matrix	identmatrix	matrix	Replace matrix with identity transform
int1 int2	idiv	quotient	Divide <i>int1</i> by <i>int2</i> ; integer quotient
dx' dy'	idtransform	dx dy	Transform distance from device to user space
dx' dy' matrix	idtransform	dx dy	Transform distance by inverse of matrix
bool proc	if		Do <i>proc</i> if <i>bool</i> is true
bool proc1 proc2	ifelse		Do <i>proc1</i> if <i>bool</i> is true; otherwise do <i>proc2</i>
dict	image		Print bit-mapped image
wd ht bits matrix proc	image		
dict	imagemask		Print binary mask
wd ht invt matrix proc	imagemask		
objn...obj0 n	index	objn...obj0 objn	Copy n-th object to top of stack
x y userpath	Ⓢ ineofill ineofill	bool	Test the current path on the even-odd rule for insideness
x y userpath	Ⓢ infill infill	bool	Test the current path for insideness
	initclip		Initialize clipping path
	initgraphics		Reset graphics state parameters
	initmatrix		Initialize current transfer matrix
x y userpath	Ⓢ instroke instroke	bool	Test pixels in the current path for insideness

Table 7.45. KPDL Page Description Operators (Sheet 6 of 11)

Preceding stack	Operator	Result	Description
x y userpath userpath1 userpath2	② inueofill inueofill	bool	Test the user path on the even-odd rule for insideness
x y userpath userpath1 userpath2	② inufill inufill	bool	Test the user path for insideness
x y userpath	② inustroke		
x y userpath matrix	inustroke		
userpath1 userpath2 userpath1 userpath2 matrix	inustroke inustroke	bool	Test pixels in the user path for insideness
matrix1 matrix2	invertmatrix	matrix2	Replace matrix2 with inverse of matrix1
	② ISOLatin1Encoding	array	Push the ISO Latin-1 encoding vector
x' y'	itransform	x y	Transform coordinates from device to user space
x' y' matrix	itransform	x y	Transform coordinates by inverse of matrix
dict key	known	bool	Test whether key is in dictionary
proc string	kshow		Print string, executing proc between characters
	② languagelevel	int	Return the language level
num/string1 num/string2	le	bool	Test whether num/string1 is less than or equal to num/string2
array	length	int	Get number of elements in array
dict	length	int	Get number of key-value pairs in dict
string	length	int	Get length of string
name	length	int	Get length of name
x y	lineto		Create line from current point to (x, y)
num	ln	real	Get natural logarithm
key	load	value	Search dictionary stack for key and return value
num	log	real	Get logarithm
proc	loop		Do proc until exit is encountered
num/string1 num/string2	lt	bool	Test whether num/string1 < num/string2
font matrix	makefont	font'	Generate new font by matrix transformation
dict matrix	② makepattern	pattern	Create an instance from a prototype pattern
	mark	mark	Push mark on stack
	matrix	matrix	Create identity matrix
dict	maxlength	int	Get capacity of dict
int1 int2	mod	remainder	Find int1 module int2 (integers)
x y	moveto		Move current point to (x, y)
num1 num2	mul	product	Multiply num1 by num2
obj1 obj2	ne	bool	Test whether obj1 is not equal to obj2
num1	neg	num2	Get negative of num1
	newpath		Initialize current path to null path
array/dict/file/string	noaccess	array/dict/file/string	Disable all access
int/bool1	not	int/bool2	Bitwise or logical not
	null	null	Push null on operand stack
	nulldevice		Install no-output device
int/bool1 int/bool2	or	int/bool3	Bitwise or logical OR
obj0...objn-1 n	② packedarray	packedarray	Create a packed array

Table 7.45. KPDFL Page Description Operators (Sheet 7 of 11)

Preceding stack	Operator	Result	Description
	pathbbox	llx lly urx ury	Get bounding box of current path
move line curve close	pathforall		Do named procedures for current path elements
obj	pop		Discard top object on stack
string	print		Write string to standard output
obj tag	Ⓜ printobject		Write a binary object sequence to the standard output
	Ⓜ product	string	Get product name
	prompt		Prompt for interactive input
	pstack		Write entire stack to standard out put
array index object	put		Insert object into array at index location
dict key value	put		Place key and value in dictionary
string index int	put		Replace character in string at index location
array1 index array2	putinterval		Replace subarray of <i>array1</i> starting at <i>index</i> by <i>array2</i>
string1 index string2	putinterval		Replace substring of <i>string1</i> starting at <i>index</i> by <i>string2</i>
	quit		Terminate KPDFL interpreter
	rand	int	Generate pseudo-random integer
array/dict/file/string	rcheck	bool	Test if object is read-accessible
dx1 dy1 dx2 dy2 dx3 dy3	rcurveto		Create Bézier cubic curve to relative point
file	read	int true or false	Read one character from file; return false if end of file
file string	readhexstring	substring bool	Read hexadecimal characters from file into string
file string	readline	substring bool	Read line from file into string; return true if filled
array/dict/file/string	readonly	array/dict/file/string	Enable read access only
file string	readstring	substring bool	Convert file of hexadecimal character codes into character string; return true if string is filled
	Ⓜ realtime	int	Return the real time clock value
x y width height numarray/numstring	Ⓜ rectclip rectclip		Clip with a rectangular path
x y width height numarray/numstring	Ⓜ rectfill rectfill		Fill with a rectangular path
x y width height x y width height matrix numarray numarray matrix numstring numstring matrix	Ⓜ rectstroke rectstroke rectstroke rectstroke rectstroke		Stroke with a rectangular path
old new	Ⓜ renamefile		Change the name of a file
int proc	repeat		Do proc int times
file	resetfile		Clear buffer for file
template proc scratch category	Ⓜ resourceforall		Enumerate all instances of a specified resource category
key category	Ⓜ resourcestatus	status size true (false)	Return status information about a named resource instance
save	restore		Restore saved virtual memory
	reversepath		Reverse direction of current path printing system's software
	Ⓜ revision	int	Get product revision

Table 7.45. KPD L Page Description Operators (Sheet 8 of 11)

Preceding stack	Operator	Result	Description
dx dy	rline to		Create line from current point to relative point
dx dy	rmoveto		Move current point by relative amount
ob(n-1)...ob0 n i	roll	ob(i-1)..ob0 ob(n01)..obi	Roll top n objects on stack by <i>i</i> (mod <i>n</i> )
	② rootfont	font	Return a root composite dictionary
angle matrix	rotate	matrix	Rotate matrix transformation by angle (degrees)
angle	rotate		Rotate user space by angle (degrees)
num1	round	num2	Round off num1 to nearest integer
	rrand	int	Get random number seed
string	run		Execute file
	save	save	Save virtual memory
sx sy matrix	scale	matrix	Define scaling matrix
sx sy	scale		Scale user space
font scale	scafont	font'	Generate new font by scaling old font
any	② scheck	bool	Same as gcheck
string target	search	post match head true or string false	Search for target substring in string
key scale	② selectfont		Select a font and establish the font dictionary
	② serialnumber	int	Return the serial number to represent the machine
llx lly urx ury	② setbbox		Establish a bounding box for the current path
proc	② setblackgeneration		Set the black generation function parameter
wx wy llx lly urx ury	setcachedevice		Declare width and bounds of cached character
w0x w0y llx lly urx ury w1x w1y vx vy	② setcachedevice2		Declare width and bounds of cached character
num	setcachelimit		Declare maximum byte size of cached character
mark size lower upper	② setcacheparams		Set the font cache parameters
wx wy	setcharwidth		Declare width and bounds of uncached character
cyan magenta yellow black	② setmykcolor		Set the color space to Device CMYK
comp1 comp2 ... comp n	② setcolor		Set the current color parameter
dict	② setcolorrendering		Establish a CIE-based color rendering dictionary
redfreq redang redproc greenfreq greenang greenproc bluefreq blueang blueproc grayfreq grayang grayproc	② setcolorscreen		Set the halftone parameter
array (name)	② setcolorspace		Specify a color space
redproc greenproc blueproc grayproc	② setcolortransfer		Set the transfer function parameter
array offset	setdash		Set dash pattern for lines
string dict	② setdevparams		Set parameters for I/O device
file position	② setfileposition		Reposition a file
num	setflat		Set flatness tolerance (smoothness of curves)
font	setfont		Set current font dictionary

Table 7.45. KPD L Page Description Operators (Sheet 9 of 11)

Preceding stack	Operator	Result	Description
bool	② setglobal		Set the VM allocation mode
num	setgray		Set gray level from 0 (black) to 1 (white)
gstate	② setgstate		Replace the current graphics state
halftone	② sethalftone		Establish a halftone dictionary
hue sat brt	sethsbcolor		Set hue, saturation, and brightness (converted to gray)
int	setlinecap		Set butt (0), round (1), or square (2) line ends
int	setlinejoin		Set miter (0), round (1), or bevel (2) corner type
num	setlinewidth		Set line width
matrix	setmatrix		Replace current transform matrix with given matrix
num	setmiterlimit		Set miter length limit
int	② setobjectformat		Establish the number representation
bool	② setoverprint		Set the overprint parameter
bool	② setpacking		Set the array packing mode
dict	② setpagedevice		Install a page output device. Parameters for this operator is fully detailed in <i>KPD L Page Device Parameters</i> on page 135.
pattern	② setpattern		Establish the specified pattern as the current color
red green blue	setrgbcolor		Set red/green/blue levels (converted to gray level)
freq angle proc	setscreen		Set halftone screen
bool	② setshared		Same as setglobal
num	③ setsmoothness		Set the smoothness to <i>num</i>
bool	② setstrokeadjust		Set the stroke adjust parameter
dict	② setsystemparams		Set the system parameters for interpreter
proc	settransfer		Set mapping from user gray scale to device gray scale
mark blimit	② setucacheparams		Set user path cache parameters
proc	② setundercolor_removal		Set the under color removal function parameter
dict	② setuserparams		Set user parameters for each context
int	② setvmthreshold		Set the allocation threshold used to trigger garbage collector
	② shareddict	dict	Same as globaldict
	② SharedFontDirectory	dict	Same as GlobalFontDirectory
dict	③ shfill		Fill the current clipping path with the shading defined by shading dictionary
string	show		Print string on page
	showpage		Print and reset current page
angle	sin	real	Find <i>sin</i> of angle (in degrees)
num	sqrt	real	Find square root of number
int	srand		Set random number seed
	stack		Write entire stack to standard output as text
	StandardEncoding	array	Push standard character code/name array on stack
	start		Make KPD L interpreter ready
bool passwd	② startjob	bool	Start a new job with condition
file	status	bool	Test if file is open

Table 7.45. KPDL Page Description Operators (Sheet 10 of 11)

Preceding stack	Operator	Result	Description
	statusdict	dict	Push statusdict on operand stack
	stop		Terminate procedure executed by stopped operator
obj	stopped	bool	Execute object. Return true if stop operator is executed in object, false if object completes normally
key value	store		Replace topmost definition of key
int	string	string	Create <i>string</i> of length <i>int</i>
string	stringwidth	wx wy	Get width of string in current font
	stroke		Draw line along current path
	strokepath		Compute outline of path
num1 num2	sub	difference	Subtract num2 from num1
	systemdict	dict	Push systemdict on operand stack
file	token	token true or false	Read and interpret token in file; return false if file is empty
string	token	tail token true or false	Read and interpret token in string return false if string is empty
x y	transform	x' y'	Transform coordinates from user to device space
x y matrix	transform	x' y'	Transform coordinates by matrix
tx ty	translate		Translate user space
tx ty matrix	translate	matrix	Define translation matrix
	true	true	Push boolean value true on stack
num1	truncate	num2	Discard fraction part of num1
obj	type	name	Get name identifying type of object
userpath	② uappend		Append the user path to the current path
	② ucache		Declare to cache the user path
	② ucachestatus	mark bsize bmax rsize rmax blimit	Return user path cache parameters
userpath	② ueofill		Fill a user path using the evenodd rule
userpath	② ufill		Interprets a user path to fill
dict key	② undef		Remove key and value from dictionary
key	② undefinefont		Remove a font definition
key category	② undefineresource		Remove the named resource
index	② undefineuserobject		Undefine an user object
bool	② upath	userpath	Create a user path equivalent to the current path
	userdict	dict	Push userdict on operand stack
	② UserObjects	array	Return the current user object array
	② usertime	int	Return time in milliseconds
userpath	② ustroke		Draw a line along a user path
userpath matrix	② ustroke		
userpath	② ustrokepath		Compute outline of a user path
userpath matrix	② ustrokepath		
	version	string	Return version of KPDL interpreter
int	② vmreclaim		Control the garbage collector



Table 7.45. KPD L Page Description Operators (Sheet 11 of 11)

Preceding stack	Operator	Result	Description
	vmstatus	level used maximum	Return virtual memory status: current save nesting depth, bytes used, and maximum byte size
array/dict/file/string	wcheck	bool	Test if object is write-accessible
key	where	dict true or false	Find dictionary in which key is defined
cx cy char string	widthshow		Print string with adjusted spacing for specified character
file int	write		Write one character to file
file string	writexstring		Convert string into file of hexadecimal character codes
file obj tag	Ⓜ writeobject		Write a binary object sequence to file
file string	writestring		Write string characters to file
obj	xcheck	bool	Test if object is executable
int/bool1 int/bool2	xor	int/bool3	Bitwise or logical exclusive OR
string numarray	Ⓜ xshow		Print characters with x displacement
string numarray	Ⓜ xyshow		Print characters with x/y displacements
string numarray	Ⓜ yshow		Print characters with y displacement

## KPD L Status Operators

The operations in the table below can be used when the status dictionary is open. Some also require a password.

Table 7.46. KPD L Status Operators (Sheet 1 of 5)

Preceding stack	Operator	Result	Description
	buildtime	int	Identify the build of the interpreter
	byteorder	bool	Get the native order in binary encoded tokens (true: low-order byte first, false: high-order byte first)
int (string)	checkpassword	bool	Check printing system's password (true: valid password, false: invalid password)
	defaulttimeouts	job manual wait	Get timeout values
	diskonline	bool	Check disk online (true: disk unit online, false: disk unit offline)
	diskstatus	free total	Report total disk space and free space
	dostartpage	bool	See whether printing system is set to print status page at power-up (true: output status, false: do not output)
	dosysstart	bool	See whether Sys/Start file is executed at power-up (true: execute Sys/Start, false: do nothing)
pages action	initializedisk		Format all writable disks
	jobname	string	Get current job name
	jobtimeout	int	Get number of seconds to job timeout (0: never)
	manualfeed	bool	Test whether printing system is in manual-feed mode (true: manual feed on, false: manual feed off)
	manualfeedtimeout	int	Get manual-feed time-out value
	margins	top left	Get top and left calibration margins
	newsheet		Feed out the single side printed page in duplex mode
	pagecount	int	Get number of pages printed so far (nonresettable)

Table 7.46. KPD L Status Operators (Sheet 2 of 5)

Preceding stack	Operator	Result	Description
	pagestackorder	bool	Get current stack tray (true: face down, false: face up)
	papersize	name bool	Get current paper size and orientation
string	printername	substring	Get printing system name
	product	string	Get printing system type
	ramsize	int	Check available RAM size
	realformat	string	Get native representation for real numbers in binary tokens
	revision	int	Get KPD L revision number
[integer ... integer]	setcollatorstacker		Set sorter to collator mode
job manual wait	setdefaulttimeouts		Set timeout values.
bool	setdoprintererrors		Set error-printing mode (true: print errors, false: do nothing)
int	setdoret		Set KIR level
bool	setdostartpage		Select whether to print status page at power-up (true: output power-on status, false: do not output)
bool	setdosysstart		Set Sys/Start file reading mode at power-up (true: execute Sys/Start, false: do nothing)
int	setjobtimeout		Set time-out value of current job
[integer ... integer ]	setmailboxstacker		Set sorter to mailbox mode
top left	setmargins		Set top and left calibration margins
int	setmultirayid		Set mail box identifier
bool	setpagestackorder		Set stack tray (true: face down, false: face up)
old new	setpassword	bool	Set printing system's password
string	setprintername		Assign string as printing system name
[integer ... integer]	setsorterstacker		Set sorter to sorting mode
int	setuserdiskpercent		Adjust disk size for use with KPD L
	waittimeout	int	Get wait time-out value
	a3		Set imageable area to A3 size. See <i>KPD L Printable Area</i> on page 140. This operator is in userdict.
	b4		Set imageable area to B4 size. See <i>KPD L Printable Area</i> on page 140. This operator is in userdict.
	a4		Set imageable area to A4 size. See <i>KPD L Printable Area</i> . This operator is in userdict.
	a4small		Set imageable area to small A4 size. See <i>KPD L Printable Area</i> on page 140. This operator is in userdict.
	b5		Set imageable area to B5 size. See <i>KPD L Printable Area</i> on page 140. This operator is in userdict.
	dlenvelope (110 x 220 envelope)		Set imageable area to International DL size. See <i>KPD L Printable Area</i> on page 140. This operator is in userdict.
	11x17		Set imageable area to 11 x 17 (Ledger) size. See <i>KPD L Printable Area</i> on page 140. This operator is in userdict.
	legal		Set imageable area to legal size. See <i>KPD L Printable Area</i> on page 140. This operator is in userdict.
	letter		Set imageable area to letter size. See <i>KPD L Printable Area</i> on page 140. This operator is in userdict.
	lettersmall		Set imageable area to small letter size. See <i>KPD L Printable Area</i> on page 140. This operator is in userdict.
	executivepage		Set imageable area to executive size. See <i>KPD L Printable Area</i> on page 140. This operator is in userdict.

Table 7.46. KPD L Status Operators (Sheet 3 of 5)

Preceding stack	Operator	Result	Description
	com10envelope (4.125 x 9.5 envelope)		Set imageable area to Commercial 10 envelope size. See <i>KPD L Printable Area</i> on page 140. This operator is in userdict.
	monarcenvelope (3.875 x 7.5 envelope)		Set imageable area to Monarch envelope size. See <i>KPD L Printable Area</i> on page 140. This operator is in userdict.
	com6envelope		Set imageable area to Commercial 6 envelope size. See <i>KPD L Printable Area</i> on page 140. This operator is in userdict.
	com9envelope (3.75 x 8.875 envelope)		Set imageable area to Commercial 9 envelope size. See <i>KPD L Printable Area</i> on page 140. This operator is in userdict.
	a5		Set imageable area to A5 size. See <i>KPD L Printable Area</i> on page 140. This operator is in userdict.
	a6		Set imageable area to A6 size. See <i>KPD L Printable Area</i> on page 140. This operator is in userdict.
	b6		Set imageable area to B6 size. See <i>KPD L Printable Area</i> on page 140. This operator is in userdict.
	b5envelope		Set imageable area to ISO B5 size. See <i>KPD L Printable Area</i> on page 140. This operator is in userdict.
	c4envelope		Set imageable area to c4 envelope size. See <i>KPD L Printable Area</i> on page 140. This operator is in userdict.
	c5envelope		Set imageable area to International C5 envelope size. See <i>KPD L Printable Area</i> on page 140. This operator is in userdict.
	custom		Set imageable area to custom size. See <i>KPD L Printable Area</i> on page 140. This operator is in userdict.
	postcard		Set imageable area to postcard size. See <i>KPD L Printable Area</i> on page 140. This operator is in userdict.
	doublepostcard		Set imageable area to double postcard size. See <i>KPD L Printable Area</i> on page 140. This operator is in userdict.
bool	setdefaultduplexmode		Select whether or not to print in duplex mode as default. (true: duplex, false: simplex)
	defaultduplexmode	bool	Get default duplex mode setting (true: duplex, false: simplex)
bool	setduplexmode		Set/cancel duplex mode. (true: duplex, false: simplex)
	duplexmode	bool	Get current setting of duplex mode. (true: duplex, false: simplex)
bool	setdefaulttumble		Set duplex printing tumble mode for binding on short side (true) or long side (false) of page.
	defaulttumble	bool	Get the default tumble mode setting. (true: short-edge bind, false: long-edge bind)
bool	settle		Set tumble mode. (true: short-edge bind, false: long-edge bind)
	tumble	bool	Get current tumble mode setting. (true: short-edge bind, false: long-edge bind)
	firstside	bool	During duplex printing, returns whether the current print side is the front or back. During simplex printing, returns whether the current page is even or odd. (true: front or odd page, false: back or even page)
int	setdefaultpapertray		Set the default paper tray as: 0: tray 1 1: tray 2 2: envelope feeder 3: MP tray (Cassette mode) 4: tray 3 5: tray 4 6: tray 5 7: tray 6

Table 7.46. KPD L Status Operators (Sheet 4 of 5)

Preceding stack	Operator	Result	Description
	defaultpapertray	int	Get current default paper tray.
int	setpapertray		Set current paper tray.
	papertray	int	Get current paper tray.
int	setpapertray2		Select a tray by converting the tray number that is currently specified by the PRESCRIBE tray number into a KPD L tray number.
	papertray2	int	Convert the current tray number into a PRESCRIBE tray number. PRESCRIBE tray numbers 0: MP tray 1: tray 1 2: tray 1 3: tray 1 4: tray 1 5: tray 1 6: tray 1 99: EF-1/UF-1
bool	setdefaulttrayswitch		Set the default paper tray switch. (true: Autocass, false: Autocass off)
	defaulttrayswitch	bool	Get default paper tray switch. (true: Autocass, false: Autocass off)
bool	settrayswitch		Set the current paper tray switch. (true: Autocass, false: Autocass off)
	trayswitch	bool	Get the current paper tray switch. (true: Autocass, false: Autocass off)
	a4tray		Find tray containing A4 size paper, select it as current tray, and set imageable area for A4 size paper.
	a5tray		Find tray containing A5 size paper, select it as current tray, and set imageable area for A5 size paper.
	a6tray		Find tray containing A6 size paper, select it as current tray, and set imageable area for A6 size paper.
	b5tray		Find tray containing B5 size paper, select it as current tray, and set imageable area for B5 size paper.
	b6tray		Find tray containing B6 size paper, select it as current tray, and set imageable area for B6 size paper.
	legaltray		Find tray containing legal size paper, select it as current tray, and set imageable area for legal size paper.
	lettertray		Find tray containing letter size paper, select it as current tray, and set imageable area for letter size paper.
	executivetray		Find tray containing executive size paper, select it as current tray, and set imageable area for executive size paper.
	c4envelopetray		Find tray containing International C4 envelopes, select it as current tray, and set imageable area for International C4 envelopes.
	c5envelopetray		Find tray containing International C5 envelopes, select it as current tray, and set imageable area for International C5 envelopes.
	com10envelope-tray		Find tray containing commercial #10 envelopes, select it as current tray, and set imageable area for commercial #10 envelopes.
	com6envelope-tray		Find tray containing commercial #6 envelopes, select it as current tray, and set imageable area for commercial #6 envelopes.
	com9envelope-tray		Find tray containing commercial #9 envelopes, select it as current tray, and set imageable area for commercial #9 envelopes.

Table 7.46. KPD L Status Operators (Sheet 5 of 5)

Preceding stack	Operator	Result	Description
	dlenvelopetray		Find tray containing DL size envelopes, select it as current tray, and set imageable area for DL size envelopes.
	monarcenvelopetray		Find tray containing Monarch size envelopes, select it as current tray, and set imageable area for Monarch size envelopes.
	a3tray		Find tray containing A3 size paper, select it as current tray, and set imageable area for A3 size paper.
	b4tray		Find tray containing B4 size paper, select it as current tray, and set imageable area for B4 size paper.
	ledgertray		Find tray containing ledger size paper, select it as current tray, and set imageable area for ledger size paper.
	b5envelopetray		Find tray containing ISO B5 size paper, select it as current tray, and set imageable area for ISO B5 size paper.
	doublepostcardtray		Find tray containing double postcard size paper, select it as current tray and set imageable area for double postcard size paper.
	postcardtray		Find tray containing postcard size paper, select it as current tray, and set imageable area for postcard size paper.
	customtray		Find tray containing custom size paper, select it as current tray, and set imageable area for custom size paper.
int	setdefaultoutputtray		Set the default output tray: 0: Upper tray (face down tray) 1: Lower tray (face up tray) 2: Option tray (sorter, etc.)
	defaultoutputtray	int	Get the default output tray.
int	setoutputtray		Set the current output tray.
	outputtray	int	Get the current output tray.
	appletalktype	string	Get string object designating type of printing system's AppleTalk name according to the AppleTalk Name Binding Protocol.
	doprinterrors	bool	Get setting of error information printout mode. (true: error print mode on, false: error print mode off)
bool	setdoautocontinue		Set whether to display messages on front panel and wait for ONLINE key input when an error occurs. (true: do nothing, false: display error messages)
	doautocontinue	bool	Get setting of doautocontinue mode. (true: continue processing during errors, false: halt processing when ON LINE key is pressed)
	dojamrecovery	bool	Get setting of dojamrecovery mode. (true: perform jam recovery, false: do not perform jam recovery)
	usertime	int	Get time elapsed since beginning of job processing.
	#copies	int	Get integer object indicating current number of copies setting. This operator is in userdict.

## KPDL System Parameters

The following table summarizes the system parameters.

Table 7.47. KPDL System Parameters (Sheet 1 of 2)

Preceding stack	Parameter	Result	Description
	BuildTime	int	Timestamp for printer's date of manufacture
	ByteOrder	bool	Byte order of binary encoded tokens. (true: low-order byte first, false: high-order byte first)
	CurDisplayList <sup>a</sup>	int	Indicate in bytes the memory block size used for storing <i>DisplayList</i> for the current page.
	CurFontCache <sup>a</sup>	int	Indicate in bytes the memory size used by the current font cache.
	CurFormCache <sup>a</sup>	int	Indicate in bytes the memory size used by the current form cache.
	CurOutlineCache <sup>a</sup>	int	Indicate in bytes the cache size used by <i>CharString</i> on the current harddisk.
	CurPatternCache <sup>a</sup>	int	Indicate in bytes the memory size used by the current pattern cache.
	CurScreenStorage <sup>a</sup>	int	Indicate in bytes the memory size used by the current screen.
	CurSourceList <sup>a</sup>	int	Indicate in bytes the host buffer size used by the current input device.
	CurUPathCache <sup>a</sup>	int	Indicate in bytes the memory size used by the current user path cache.
	DoAutoContinue	bool	Turn on/off the front panel display when a KPDL error occurs (true: error display off, false: error display on).
	DoPrintErrors	bool	Turn on/off error printing when a KPDL error occurs. (true: error print on, false: error print off)
	DoStartPage	bool	Indicate whether or not to print status at power on as a bool object. (true: print status, false: do not print status)
	FactoryDefaults	bool	Indicate with a boolean object whether to initialize the following parameters at power on (true: initialize, false: do not initialize [factory default]). <i>SystemParamsPassword</i> <i>StartJobPassword</i> <i>FactoryDefaults</i> <i>MaxFontCache</i> <i>MaxDisplayList</i> <i>MaxScreenStorage</i> <i>MaxUPathCache</i> <i>MaxPatternCache</i> <i>MaxOutlineCache</i> <i>MaxFormCache</i> <i>FontResourceDir</i> <i>GenericResourceDir</i> <i>GenericResourcePathSep</i>
	FontResourceDir	string	Identify the font resource directory on the harddisk. Defaults are in (fonts/).
	GenericResourceDir	string	Identify the directory for resources other than fonts on the harddisk. Defaults are in (Resource/).
	GenericResource-PathSep	string	Specify the separator character used between resource identifiers on the harddisk. Defaults are in (/).
	JobTimeout	int	Indicate the default job timeout value.
	MaxDisplayList	int	Indicate the maximum storage of <i>DisplayList</i> for the current page.
	MaxFontCache	int	Indicate the maximum storage of the font cache.
	MaxFormCache	int	Indicate the maximum storage of the form cache.
	MaxOutlineCache	int	Indicate the maximum storage of the <i>CharString</i> cache on the disk.
	MaxPatternCache	int	Indicate the maximum storage of the pattern cache.
	MaxScreenStorage	int	Indicate in bytes the maximum storage of the half-tone screen usable by the screen.

Table 7.47. KPD L System Parameters (Sheet 2 of 2)

Preceding stack	Parameter	Result	Description
	MaxSourceList	int	Indicate in bytes the maximum storage of the host buffer used by the current input device.
	MaxUPathCache	int	Indicate in bytes the maximum storage which can be used by the user path cache.
	PageCount	int	Indicate the total number of printed pages since the printer's manufacture.
	Password	int, string	Indicate the password necessary when changing system parameters and/or device parameters.
	PrinterName	string	Indicate the name given to the printer.
	RamSize	int	Indicate in bytes the total RAM capacity currently in the printer.
	RealFormat	string	Indicate the method of representing the numeric values of binary tokens.
	Revision	int	Indicate the interpreter's revision number.
	StartJobPassword	int, string	Indicate the password for <i>ExitServer</i> and <i>StartJob</i> .
	StartupMode	int	Indicate by numeric value whether to execute the (Sys/Start) file on the harddisk when first booting KPD L after power on. (0: default, 1: use Sys/Start)
	SystemParams-Password	int, string	Indicate the password for changing system parameters.
	WaitTimeout		Indicate the default wait timeout value.
	MaxImageBuffer	int	Limit the working area for processing a single image.
	MaxStoredFontCache	int	Limit the maximum font cache value stored on the disk.
	CurStoredFontCache	int	Return in bytes the font cache value found on the current disk

<sup>a</sup> Read only

## KPDL User Parameters

The following table summarizes the user parameters. The user parameters establish temporary policies on functions such as naming the current job for a user.

Table 7.48. KPDL User Parameters

Preceding stack	Parameter	Result	Description
	AccurateScreens	bool	Turn on/off the accurate mode flag for the <i>setscreen</i> operator. (true: detail screen on, false: default)
	JobName	string	Return the name of the job currently being processed by the printer.
	JobTimeout	int	Return the current job timeout value.
	MaxDictStack	int	Indicate the maximum size of the dictionary stack.
	MaxExecStack	int	Indicate the maximum size of the execution stack.
	MaxFontItem	int	Indicate the maximum number of bytes used by a pixel array for a single character in the font cache.
	MaxFormItem	int	Indicate the maximum number of bytes used by the form of a single cached form.
	MaxLocalVM	int	Indicate the maximum number of bytes of the local VM.
	MaxOpStack	int	Indicate the maximum size of the operand stack.
	MaxPatternItem	int	Indicate the maximum number of bytes used by the form of a single cached pattern.
	MaxScreenItem	int	Indicate the maximum number of bytes used by a single half-tone screen.
	MaxUPathItem	int	Indicate the maximum number of bytes used by a single cached user path.
	MinFontCompress	int	Indicate the threshold value for storing characters in the font cache not as complete pixel arrays but in compressed form.
	VMReclaim	int	Indicate the automatic garbage collection mode.
	VMThreshold	int	Indicate the threshold at which automatic garbage collection is executed once this number of bytes has been allocated after garbage collection.
	WaitTimeout	int	Return the current wait timeout value.



## KPD L Page Device Parameters

The page device parameters for *setpagedevice* allow manipulating the output devices to receive or provide various finishing operations on the printed outputs. For example, the *OutputType* parameter allows to choose paper stack as follows:

To receive the output pages in the default printer stack:

```
<</OutputType (PRINTER_STACK)>> setpagedevice
```

To receive the output pages in the finisher for stapling:

```
<</OutputType (STAPLER)>> setpagedevice
```

Table 7.49. KPD L Page Device Parameters (Sheet 1 of 3)

Preceding Stack	Parameter	Result	Description
	BeginPage	array	Indicate <i>BeginPage</i> procedure operations. This parameter is called together with the number of times <i>showpage</i> has executed since the beginning of the page. (default: {pop})
	Duplex	bool	Return as a boolean object the current duplex mode. (true: duplex, false: simplex)
	EndPage	array	Indicate <i>EndPage</i> procedure operations. This parameter is called together with the number of times <i>showpage</i> has executed since the end of the page. (default: {exch pop 2 ne})
	ExitJamRecovery	bool	Return as a boolean value whether to perform recovery when a paper jam occurs. (Read only) [true]
	HWRResolution	array	Indicate the resolution of the physical device. (300dpi: [300 300], 600dpi: [600 600], 1200dpi: [1200 1200])
	ImagingBBox	array	Specify any bounding box for the entire page. (default: null)
	InputAttributes	dict	Indicate the dictionary associated with a currently available input device (paper tray) using the number assigned to each.
	Install	array	Execute the procedure for installing values during graphics mode when calling the <i>setpagedevice</i> operator.
	ManualFeed	bool	Set whether to perform manual feed. (true: MF on)
	ManualFeedTimeout	int	Return the manual feed timeout. (Read only) [0]
	Margins	array	Set the printer margins. (default: [0 0])
	MediaColor	string	Use this parameter along with <i>/PageSize</i> , <i>/MediaWeight</i> , and <i>/MediaType</i> when the user selects a tray.
	MediaType	string <sup>a</sup>	Use this parameter along with <i>/PageSize</i> , <i>/MediaWeight</i> , and <i>/MediaColor</i> when the user selects a tray. For details on media type, see footnote below.
	MediaWeight	int	Use this parameter along with <i>/PageSize</i> , <i>/MediaType</i> , and <i>/MediaColor</i> when the user selects a tray.
	NumCopies	int	Set the current copy count. Normally null; when null is specified here, <i>#copies</i> in <i>userdict</i> takes precedence.
	OutputAttributes	dict	Indicate the dictionary containing media output entries available for the current output device (printer output tray, sorter, etc.).
	OutputFaceUp	bool	Set the printer's output stack. (true: face up, false: face down)
	OutputType	string	Indicate parameters set by the user when selecting the output stack. See example below.
	PageSize	array	Use this parameter along with <i>/MediaColor</i> , <i>/MediaWeight</i> , and <i>/MediaType</i> when the user selects a tray. Refer to <i>KPD L Printable Area</i> on page 140 (Ex: [612 792] LETTER, [595 842] A4).

Table 7.49. KPD L Page Device Parameters (Sheet 2 of 3)

Preceding Stack	Parameter	Result	Description
	Policies	dict	Execute the policies function. This is checked when the device cannot satisfy the user-specified <i>setpagedevice</i> .
	PostRendering-Enhance	bool	Turn on/off KIR mode. (true: KIR on, false: KIR off)
	PostRendering-EnhanceDetails	dict	Set the dictionary representing the KIR mode when <i>PostRenderingEnhance</i> is true.
	SorterDetails <sup>b</sup>	dict	Set the dictionary object for current sorter status information.
	TraySwitch	bool	Set the current auto cassette (mode status) using a boolean value. (true: Autocass, false: Autocass off)
	Tumble	bool	Set the current tumble mode using a boolean value. (true: shortedge, false: longedge)
	DeferredMedia-Selection	bool	Define using a boolean object the processing when the page size selected during page setup differs from the paper size of the tray. (true: display cassette error)
	ProcessColorModel	name	Return the engine type as a name object. /Device Gray: Monochrome /Device CMY: Three colors /Device CMYK: Four colors
	MediaPosition	int	Set the tray corresponding to the specified number as the current tray.
	OutputPage	bool	Set whether to output paper. (true: default, false: no output paper)
	Collate	bool	Turn on/off the collate function. (true: electric collate on (only when harddisk is installed))
	CollateDetails	dict	Control the detailed parameters of the collate function. See <i>CollateDetails Parameters</i> on page 138.
	Fold	int	Fold booklet pages. (DF-75 finisher) 0: Do not fold 3: Fold
	FoldDetails	dict	Control the detailed parameters of folding. See <i>FoldMode</i> and <i>FoldCount</i> below.
	FoldMode	int	1: Fold/staple booklet pages
	FoldCopy	int	Control the number of pages to be folded. 0: Do not fold the pages whose number exceeds the maximum -1: Fold the rest of the pages whose number exceeds the maximum 2: Fold every two pages 3: Fold every three pages ... 10: Fold every ten pages
	Jog	int	Jog the output every n pages as given by the integer code. 0: Do not jog 3: Jog using the given jog offset (only when optional stacker is installed)
	Staple	int	Staple the output every n pages as given by the integer code. 0: Do not staple 3: Staple when job is finished
	StapleDetails <sup>c</sup>	dict	Control the detailed parameters of the staple function.
	EconoMode	bool	Control Econoprint mode. true: Econoprint on false: Econoprint off
	Punch <sup>d</sup>	int	Punch output pages. (DF-71/DF-75) 0: Do not punch 3: Punch when a set of job is printed.
	PunchDetails	dict	Controls the detailed parameters of the punch. See/PunchMode below.

Table 7.49. KPDL Page Device Parameters (Sheet 3 of 3)

Preceding Stack	Parameter	Result	Description
	PunchMode	int	Punch using sub style. (DF-71) 1: Native style of punching 2: Sub style
	SlipSheet	int	Insert transparency separator. 0: No separator 3: Insert a separator when a set of job is printed.
	SlipSheetDetails	dict	Control the detailed parameters of punching. See CopyMode below.
	CopyMode	int	Print on transparency separator. 1: Do not print on separator 2: Print on separator
	PreRenderingEnhance	bool	Control resolution enhancement. When <i>/HWResolution</i> is set to 600 dpi. true: Fast 1200dpi false: 600dpi
	DeviceRenderingVividInfo	dict	Model FS-5900C only. Control vivid color mode. Ex: << /DeviceRenderingVividInfo << /VividColor bool >> >> setpagedevice bool (true: Vivid mode on, false: Vivid mode off)
	DeviceRenderingRGBInfo	dict	Controls RGB emulation. Ex: << /DeviceRenderingRGBInfo << /VirtualColorDevice << /ColorTransform name >> >> >> setpagedevice name /sRGB << /DeviceRenderingRGBInfo << /VirtualColorDevice null >> >> setpagedevice RGB emulation is not performed.
	DeviceRenderingCMYKInfo	dict	Controls ink simulation. Ex: << /DeviceRenderingCMYKInfo << /VirtualColorDevice << /ColorTransform name >> >> >> setpagedevice name /SWOP /EURO /Normal: Normal ink simulation << /DeviceRenderingCMYKInfo << /VirtualColorDevice null >> >> setpagedevice Does not perform ink simulation.

<sup>a</sup> Available media type strings are as follows:

- (Plain)
- (Transparency)
- (Preprinted)
- (Labels)
- (Bond)
- (Recycled)
- (Vellum)
- (Rough)
- (Letterhead)
- (Color)
- (Prepunched)
- (Envelope)
- (Card Stock)
- (CoatedPaper)
- (Duplex)
- (Custom Type1)
- (Custom Type2)
- (Custom Type3)
- (Custom Type4)
- (Custom Type5)
- (Custom Type6)
- (Custom Type7)
- (Custom Type8)

- b *SorterDetails* can specify tray arrangement and sorter operation mode as the following example:  

```
<< /SorterDetails << /SorterTray[1 2]/SorterMode(SORTER)>> >>
setpagedevice
```

Tray arrangement array of [1 2] specifies tray 1 and tray 2 to be used. If tray numbers are omitted ([ ]), all trays are used. Sorter mode string of (SORTER) specifies sorter mode. Other options include (COLLATOR) and (MAILBOX).
- c A typical *StapleDetails* sequence is as follows. To staple each 20 pages at position 3 on the page:  

```
<< /Staple 3 /StapleDetails << /StaplePosition 3 /Count 20 >> >>
setpagedevice
```
- d To punch in sub style, use the following example:  

```
<< /Punch 3 /PunchDetails << /PunchMode 2 >> >> setpagedevice
```

## CollateDetails Parameters

*CollateDetails* has the following parameters as tabled below according to the key of operations. By making */Collate* true, *CollateDetails* enables the printing system to implement the e-MPS function according to the keys explained in the following table.

Table 7.50. *CollateDetails* Parameters

Key	Type	Meaning	Parameters	default
<i>/Mode</i>	integer	Job mode	0: HP Mopier mode/Job retention 1: Volatile job 2: Nonvolatile job 8: VirtualMailbox job	0
<i>/Type</i>	integer	Job Retention enable	8: Enable Job Retention	—
<i>/Hold</i>	integer	Job Retention mode	1: QuickCopy 2: Stored job 3: Proof and Hold	—
<i>/HoldType</i>	integer	Job Retention security	0: No security 1: Security with PIN code	0
<i>/HoldKey</i>	integer	PIN code	Number of 4 bytes	—
<i>/Barcode</i>	integer	Barcode output	0: Output on first page 1: Output on all pages 2: Do not output	2
<i>/BarcodePosition</i>	integer	Barcode printing position (viewed in portrait orientation)	0: Lower right (bar only) 1: Lower right perpendicular (bar only) 2: Upper right perpendicular (bar only) 3: Upper right (bar only) 4: Upper left (bar only) 5: Upper left perpendicular (bar only) 6: Lower left perpendicular (bar only) 7: Lower left (bar only) 128: Lower right (bar + ID) 129: Lower right perpendicular (bar + ID) 130: Upper right perpendicular (bar + ID) 131: Upper right (bar + ID) 132: Upper left (bar + ID) 133: Upper left perpendicular (bar + ID) 134: Lower left perpendicular (bar + ID) 135: Lower left (bar + ID)	0
<i>/Share</i>	integer	Share flag	0: Shared 1: Not shared	0
<i>/Name</i>	string	Job name	Character string up to 31 bytes maximum	()
<i>/User</i>	string	User name	Character string up to 31 bytes maximum	()
<i>/Time</i>	string	Time stamp	Character string up to 31 bytes maximum	()
<i>/Destination</i>	array	VMB destination	—	[]

## Programming with CollateDetails for Job Retention

*CollateDetails* enables the printing system to implement the e-MPS Job Retention function in KPDLL mode. The */Mode* key must be set to true for all of these functions. The

keys to the CollateDetails parameter should have the following integer values depending on the mode of each e-MPS function.

*Table 7.51. Enabling e-MPS Functions*

e-MPS	/Collate	/CollateDetails << >>				
		/Mode	/Type	/Hold	/Hold-Type	/HoldKey
Electronic sorting	true	0		0		
Temporary job storage	true	1				
Permanent job storage	true	2				
Virtual mailbox	true	8				
QuickCopy	true	0	8	1	0	
QuickCopy (Private)	true	0	8	1	1	(1234)
Proof and Hold	true	0	8	3		
Stored job	true	0	8	2	0	
Stored job—PIN secured	true	0	8	2	1	(1234)

*Examples:*

To post a print job into the virtual mailbox aliased Robert, a typical CollateDetails sequence of parameters will be as follows:

```
<< /Collate true /CollateDetails << /Mode 8
/destination [(Robert)]>> setpagedevice
```

## KPD L Error Messages

Depending on the setting of the *doautocontinue* parameter, the printing systems having the operator display display errors occurring during operation in the KPD L mode as follows.

KPD L Error ## .. Press ON LINE
------------------------------------

Any of the following error codes will appear if errors occur and *doautocontinue* is set to false. When *doautocontinue* is set to true, only error codes 00 and 98 are available. These error codes are also reported from the printer to the computer. Some software will display these error names on the computer screen.

*Table 7.52. KPD L Error Messages*

Code	Error	Meaning
00		Cannot initiate KPD L
01	dictfull	Dictionary full; no new entries can be added
02	dictstackoverflow	Too many begins
03	dictstackunderflow	Too many ends
04	execstackoverflow	Execution stack nesting depth exceeded 250
05	handle	Name of error-reporting procedure
06	interrupt	Control-C was received
07	invalidaccess	Attempted violation of access attribute
08	invalidexit	Exit not enclosed in any loop
09	invalidfile	Invalid access string for file operator
10	invalidfont	Invalid font name or invalid font dictionary format
11	invalidrestore	Restore would destroy composite object created after save

Table 7.52. KPD L Error Messages

Code	Error	Meaning
12	ioerror	Input/output error
13	limitcheck	Path too complex, more than 6 files open, etc.
14	nocurrentpoint	No current point is defined
15	rangecheck	Operand out of allowed range
16	stackoverflow	Operand stack overflow
17	stackunderflow	Operand stack underflow
18	syntaxerror	Syntax error in program
19	timeout	Time limit exceeded
20	typecheck	Wrong type of operand
21	undefined	Name not found in dictionary
22	undefinedfilename	File cannot be found
23	undefinedresult	Overflow, underflow, or meaningless result
24	unmatchedmark	Expected mark not found on stack
25	unregister	Internal error
26	vmerror	Virtual memory is exhausted, or illegal access was attempted
27	badpassword	Bad password
28	invalidnumber	Invalid number
29	nomemory	Memory unavailable
30	configurationerror	<i>Setpagedevice</i> request cannot be satisfied
31	invalidcontext	Improper use of context operation
32	invalidid	Invalid identifier for external object
33	undefinedresource	Resource instance not found
98	fatal	Fatal error (User memory exhausted)

## KPDL Printable Area

This printing system does not quite print to the edges of the paper. The edge limits of the printable area vary depending on the paper type as determined by the paper type KPDL operator. The edge limits are located as shown in the following figure and table. They adjust automatically to the size of the paper cassette (although not to the size of manually fed paper).

Figure 7.53. Printable Area

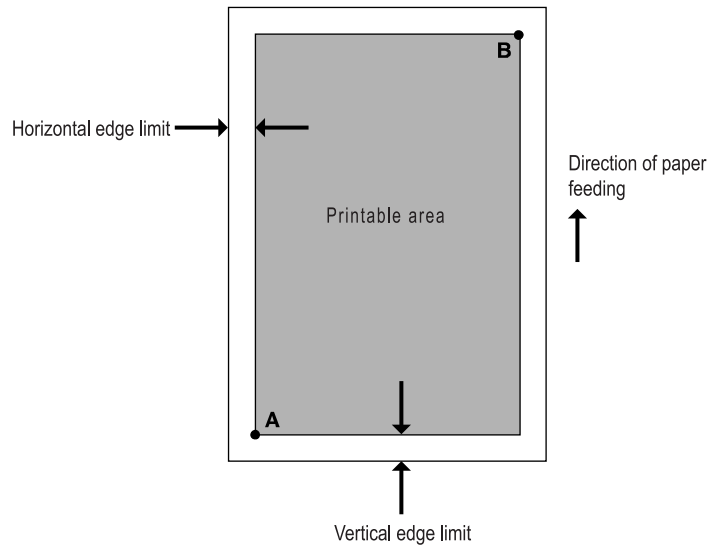

Table 7.54. Paper Sizes and Printable Area

Paper type	Paper size		Edge limits (A above)				Printable area (B above)	
			Horizontal		Vertical		cm	Pt.
	cm	Points	cm	Pt.	cm	Pt.		
A3 <sup>a</sup>	29.7 x 42.0	842 x 1191	0.42	12	0.35	10	28.85 x 41.31	818 x 1171
B4 <sup>a</sup>	25.7 x 36.4	728 x 1032	0.42	12	0.35	10	24.83 x 35.70	704 x 1012
A4	21.0 x 29.7	595 x 842	0.42	12	0.35	10	20.14 x 28.99	571 x 822
A4 Small	21.0 x 29.7	595 x 842	0.875	25	0.875	25	19.22 x 27.94	545 x 792
A5	14.8 x 21.0	421 x 595	0.42	12	0.35	10	14 x 20.28	397 x 575
A6	10.5 x 14.8	297 x 421	0.42	12	0.35	10	9.63 x 14.14	273 x 401
B5	18.2 x 25.7	516 x 729	0.74	21	0.35	10	16.72 x 25.01	474 x 709
B6	12.8 x 18.2	364 x 516	0.42	12	0.35	10	11.99 x 17.49	340 x 496
Int'l DL	11.0 x 22.0	312 x 624	0.42	12	0.35	10	10.16 x 21.3	288 x 604
Int'l B5	17.6 x 25.0	499 x 708	0.42	12	0.42	12	16.75 x 24.13	475 x 684
Int'l C4 <sup>a</sup>	22.9 x 32.4	649 x 919	0.42	12	0.35	10	22.0 x 31.7	625 x 899
Int'l C5	16.2 x 22.9	459 x 649	0.42	12	0.35	10	15.34 x 22.18	435 x 629
Double-postcard	14.8 x 20.0	421 x 595 <sup>b</sup>	0.42	12	0.49	14	14.00 x 20.00	397 x 567
		420 x 567 <sup>a</sup>	0.35	10	0.35	10	14.11 x 19.30	400 x 547
Postcard	10 x 14.8	297 x 421 <sup>b</sup>	0.46	13	0.35	10	9.56 x 14.14	271 x 401
		283 x 420 <sup>a</sup>	0.35	10	0.35	10	9.28 x 14.11	263 x 400
Ledger <sup>a</sup>	11 x 17	792 x 1224	0.16	12	0.11	8	10.68 x 16.78	768 x 1208
Legal	8.5 x 14	612 x 1008	0.16	12	0.11	8	8.18 x 13.78	588 x 992
Letter	8.5 x 11	612 x 792	0.16	12	0.11	8	8.18 x 10.78	588 x 776
Ltr Small	8.5 x 11	612 x 792	0.35	25	0.35	25	7.8 x 10.3	562 x 742
Executive	7.25 x 10.5	522 x 756	0.16	12	0.11	8	6.93 x 10.28	498 x 740
Com. #10	4.125 x 9.5	297 x 684	0.16	12	0.11	8	3.79 x 9.28	273 x 668
Monarch	3.875 x 7.5	279 x 540	0.16	12	0.11	8	3.555 x 7.28	255 x 524
Com. #6	3.625 x 6.5	261 x 468	0.16	12	0.11	8	3.29 x 6.28	237 x 452
Com. #9	3.875 x 8.875	279 x 639	0.16	12	0.11	8	3.54 x 8.666	255 x 623
Custom <sup>a</sup>	11.7 x 17.7	842 x 1274	0.11	8	0.11	8	11.47 x 17.47	826 x 1258

<sup>a</sup> For A3/ledger models.

<sup>b</sup> For A4/letter models.

This page is left blank intentionally.



# Index

## Numerics

16-bit word, 4-13

## A

Absolute coordinates, 2-19

Absolute position, 2-2

Arc, 2-10

    path mode drawing, 2-24

## B

Baseline, 1-8

Beveled line join, 2-21

Bézier curve, 2-26

Binary number, 2-13, 4-13

Bit image, 2-34

Bitmap font, 4-6

Bitmap fonts, 1-6, 4-6

block, 2-10

Box, 2-6

Butt cap, 2-20

## C

Cartesian (X,Y) coordinates, 2-5

Case, 1-12

    exception, 1-13

Cassette size, 1-4

Character cells, 1-8

Character path, 2-33

Character set

    KC-GL, 7-96

Character spacing, 1-8

Character string, 1-11

Check digit, 5-2

Circle, 2-9

Clipping a path, 2-16

Clipping path, 2-32

    basic concept, 1-9

Clipping rectangle, 2-32

Closed path, 2-29

Command name, 1-4

Command parameter

    angle parameter, 1-11

    character string, 1-11

    numeric parameter, 1-10

    special parameters, 1-13

Complex curves, 2-26

Compressing raster data, 2-34

Compression (SFNT), 4-8

Control byte, 2-34

Control codes

    Diablo 630, 7-14

    Epson LQ-850, 7-24

    HP LaserJet series, 7-49

    IBM Proprinter, 7-6

Coordinates, 1-7, 1-9, 2-2

Creating new symbols, 4-12

Current path, 2-18

Current position, 1-7

Cursor, 1-7

Cursor position, 2-2

Curved line, 2-16

Curves drawing in path mode, 2-24

## D

Dash pattern, 2-23

    defining, 2-23

    user defined, 2-23

Dash type, 2-22

Dashed line, 2-22

Decimal place, 1-11

Default font, 4-2

Destination image, 2-37

Diablo 630

    character set, 7-16

    control code, 7-14

    emulation, 7-12

Dot resolution, 2-34, 2-36

Double-high printing, 7-5

Double-strike printing, 7-5

Double-wide fonts, 7-21

Double-wide printing, 7-5

Downloadable font, 4-2

Dummy parameter, 3-3

Dummy sign (macro), 3-2

## E

EAN barcode, 5-4

Edge limits, 1-4, 2-32

Emulation, 7-1

    general, 7-3

    selection, 7-2

    transmission, 1-2

Ending angle, 2-24

Entry and Exit, 1-2

Epson LQ-850

    character set, 7-26

- control codes, 7-24
- emulation, 7-21

Even-odd rule (FILL), 2-32

## F

Fill pattern, 2-10

- defining, 2-12

Filled area, 1-9, 2-30

Filled block, 2-10

Flag, 5-2

Flatness of curves, 2-28

Font

- characteristics, 4-9
- definition, 4-2
- identifying characteristics, 4-1
- selection, 4-7

Font mode, 4-10, 7-22

Font name, 4-6

Font number

- assigning to a scalable font (SFNT), 4-8

Font orientation, 4-9

Font selection, 4-7, 7-35

- by embedded software commands, 4-12
- by PRESCRIBE, 4-7
- font selection commands, 4-7
- priority, 4-9

Font selection command

- placement in a file, 4-11

Footnote, 4-11

FRPO parameters, 6-1

## G

Graphics state, 2-39

Gray scale, 2-16, 2-29, 2-30

## H

HP LaserJet series

- character set, 7-67
- emulation, 7-33
- font selection, 7-35
- printer commands, 7-49

HP PCL

- language, 1-13

HP-GL/2

- language, 1-6
- printer commands, 7-64

Human-readable text (barcode), 5-3

Human-readable text (macro), 5-2

## I

IBM Proprinter

- character set, 7-9
- control codes, 7-6
- emulation, 7-4

Imaging model, 2-37

International characters

- KC-GL, 7-109

## K

KC-GL

- character sets, 7-107
- coordinates, 7-98
- default status, 7-114
- device control, 7-106
- emulation, 7-96
- instruction format, 7-96
- instructions (table), 7-111
- modes A and B, 7-98
- parameter format, 7-97
- pen selection, 7-99
- status information, 7-102

KPDL, 4-4, 7-115

## L

Line

- drawing, 2-2
- path mode, 2-18

Line end (caps), 2-20

Line join, 2-21

Line join mode, 2-21

Line printer emulation, 7-3

Line width, 2-2

Line-cap mode, 2-20

Lines, 2-2

- relative, 2-4
- zero-relative, 2-3

Logical page, 1-9

## M

Margins, 1-4, 1-6, 2-2

Memory card, 4-2

Miter limit, 2-21

- values, 2-22

Mitered line join, 2-21

MSI barcode, 5-2

## N

Native language, 1-1

Notched line join, 2-21

## O

Origin, 1-7

## P

Page direction, 1-5  
Page orientation, 1-5  
Path mode graphics, 2-16  
Pattern number, 2-22, 2-24  
Permanent parameters, 6-1  
Physical page, 1-9  
Pie charts, 2-14  
Plotter units, 7-100  
PRESCRIBE  
    command length limit, 1-4  
    format, 1-4  
Presentation mode, 2-36  
Print direction, 1-6  
Print model, 2-1  
Proportional fonts, 1-8  
Proportional spacing, 1-8

## Q

Quotation marks, 1-11

## R

Radius, 2-9, 2-15  
Raster data  
    in tagged image file format, 2-34  
    printing commands, 2-35  
    run-length compressed, 2-34, 7-35  
    uncompressed, 2-34  
Raster graphics, 2-34  
    compression formats, 2-34  
Real number (KC-GL), 7-97  
Relative coordinates, 2-19  
Resident fonts, 4-2  
Roman Extension, 7-33  
Roman-8, 7-33, 7-37  
Roman-8 symbol set, 4-8  
Round cap, 2-20  
Round line join, 2-21  
Row-work, 2-13

## S

Scalable font, 4-2  
    assigning a font number to, 4-8  
    lists, 4-2  
    outline, 4-2  
Scaled real number (KC-GL), 7-97  
Scaling point (KC-GL), 7-101  
Short and tall parameters (barcode), 5-3

Soft fonts, 4-2

Source image, 2-37

Spacing commands, 4-10

Square cap, 2-20

Standard graphics mode, 2-2

Standard mode and path mode logical page, 1-9

Starting angle, 2-15, 2-24

Stroking a path, 2-16

Subpath, 2-17

    basic concept, 1-9

Superscripts & subscripts, 7-5

Symbol set

    default selection, 7-37

Symbol set (SFNT), 4-8

## T

Tagged image file format (TIFF), 2-34, 7-35

Text positioning, 1-7

Thickness of lines, 2-3

Tilt (SFNT), 4-8

Transparency mode, 2-37

Two's complement (TIFF), 2-35

Typeface, 4-1

## U

Unprintable area, 2-2

Upper and lowercase letters, 1-12

US ASCII, 7-3, 7-33

US Legal, 7-3

User unit (KC-GL), 7-100

USPS (barcode), 5-2

## W

Word-processing software, 1-5, 4-12, 7-1

## X

X/Y (coordinates), 1-7

## Z

Zero-relative coordinates, 2-24

## KYOCERA MITA AMERICA, INC.

### **Headquarters:**

225 Sand Road,  
Fairfield, New Jersey 07004-0008  
TEL : (973) 808-8444  
FAX : (973) 882-6000

### **New York Branch:**

1410 Broadway 23rd floor  
New York, NY 10018  
TEL : (917) 286-5400  
FAX : (917) 286-5402

### **Northeastern Region:**

225 Sand Road,  
Fairfield, New Jersey 07004-0008  
TEL : (973) 808-8444  
FAX : (973) 882-4401

### **Midwestern Region:**

201 Hansen Court Suite 119  
Wood Dale, Illinois 60191  
TEL : (630) 238-9982  
FAX : (630) 238-9487

### **Western Region:**

14101 Alton Parkway,  
Irvine, California 92618-7006  
TEL : (949) 457-9000  
FAX : (949) 457-9119

### **Southeastern Region:**

1500 Oakbrook Drive,  
Norcross, Georgia 30093  
TEL : (770) 729-9786  
FAX : (770) 729-9873

### **Southwestern Region:**

2825 West Story Road,  
Irving, Texas 75038-5299  
TEL : (972) 550-8987  
FAX : (972) 252-9786

### **National Operation Center & National Training Center:**

2825 West Story Road,  
Irving, Texas 75038-5299  
TEL : (972) 659-0055  
FAX : (972) 570-5816

### **Latin America Division:**

8240 N.W. 52nd. Terrace Dawson Building,  
Suite 108 Miami, Florida 33166  
TEL : (305) 421-6640  
FAX : (305) 421-6666

## KYOCERA MITA CANADA, LTD.

6120 Kestrel Road, Mississauga,  
Ontario L5T 1S8, Canada  
TEL : (905) 670-4425  
FAX : (905) 670-8116

## KYOCERA MITA MEXICO, S.A. DE C.V.

Av. 16 de Septiembre #407  
Col. Santa Inés,  
Azcapotzalco México,  
D.F. 02130, México  
TEL : (55) 5383-2741  
FAX : (55) 5383-7804

## KYOCERA MITA EUROPE B.V.

Hoeksteen 40, 2132 MS Hoofddorp,  
The Netherlands  
Phone: +31.20.654.0000  
Home page: <http://www.kyoceramita-europe.com>  
Email: [info@kyoceramita-europe.com](mailto:info@kyoceramita-europe.com)

KYOCERA MITA NEDERLAND B.V.  
Beechavenue 25, 1119RA Schiphol-Rijk  
The Netherlands  
Phone: +31.20.58.77.200

KYOCERA MITA (UK) LTD  
8 Beacontree Plaza  
Gillette Way Reading Berks RG2 OBS,  
U.K.  
Phone: +44.1189.311.500

KYOCERA MITA ITALIA S.p.A.  
Via G. Verdi, 89 / 91, 20063 Cernusco s/N  
Milano, Italy  
Phone: +39.02.92179.1

S.A. KYOCERA MITA BELGIUM N.V.  
Sint-Martinusweg 199-201, 1930 Zaventem,  
Belgium  
Phone: +32.2.720.9270

KYOCERA MITA FRANCE S.A.  
Parc Les Algorithmes Saint Aubin  
91194 GIF-SUR-YVETTE,  
France  
Phone: +33.1.6985.2600

KYOCERA MITA ESPAÑA S.A.  
Edificio Kyocera, Avda de Manacor No. 2,  
28290 Las Matas (Madrid),  
Spain  
Phone: +34.91.631.8392

KYOCERA MITA FINLAND OY  
Kirvesmiehenkatu 4, 00880 Helsinki,  
Finland  
Phone: +358.9.4780.5200

KYOCERA MITA (SCHWEIZ)  
Hohlstrasse 614, 8048 Zürich  
Switzerland  
Phone: +41.1.908.4949

KYOCERA MITA DEUTSCHLAND GMBH  
Otto-Hahn-Str. 12 D-40670 Meerbusch,  
Germany  
Phone: +49.2159.918.0

KYOCERA MITA GMBH AUSTRIA  
Eduard-Kittenberger-Gasse 95,  
1230 Wien,  
Austria  
Phone: +43.1.86338.210

KYOCERA MITA SVENSKA AB  
Esbogatan 16B 164 75 Kista,  
Sweden  
Phone: +46.8.546.55000

KYOCERA MITA NORGE  
Postboks 150 Oppsal, NO 0619 Oslo  
Olaf Helsetsvvei 6, NO 0694 Oslo,  
Norway  
Phone: +47.22.62.73.00

KYOCERA MITA DANMARK A/S  
Ejby Industrivej 1, DK-2600 Glostrup,  
Denmark  
Phone: +45.5687.1100

KYOCERA MITA PORTUGAL LDA.  
Rua do Centro Cultural, 41 (Alvalade) 1700-106 Lisbon,  
Portugal  
Phone: +351.21.842.9100

KYOCERA MITA SOUTH AFRICA (PTY) LTD.  
527 Kyalami Boulevard,  
Kyalami Business Park Midrand,  
South Africa  
Phone: +27.(0)11.540.2600

## KYOCERA MITA AMERICA, INC.

Headquarters:  
225 Sand Road,  
Fairfield, New Jersey 07004-0008,  
U.S.A.  
Phone: (973) 808-8444

KYOCERA MITA AUSTRALIA PTY. LTD.  
Level 3, 6-10 Talavera Road, North Ryde,  
N.S.W. 2113 Australia  
Phone: (02) 9888-9999

KYOCERA MITA NEW ZEALAND LTD.  
1-3 Parkhead Place, Albany  
P.O. Box 302 125 NHPC, Auckland,  
New Zealand  
Phone: (09) 415-4517

KYOCERA MITA (THAILAND) CORP., LTD.  
9/209 Ratchada-Prachachem Road,  
Bang Sue, Bangkok 10800, Thailand  
Phone: (02) 586-0320

KYOCERA MITA SINGAPORE PTE LTD.  
121 Genting Lane, 3rd Level,  
Singapore 349572  
Phone: 67418733

KYOCERA MITA HONG KONG LIMITED  
11/F., Mita Centre,  
552-566, Castle Peak Road,  
Tsuen Wan, New Territories,  
Hong Kong  
Phone: 24297422

KYOCERA MITA TAIWAN Corporation.  
7F-1~2, No.41, Lane 221, Gangchi Rd.  
Neihu District, Taipei, Taiwan, 114. R.O.C.  
Phone: (02) 87511560

## KYOCERA MITA Corporation

2-28, 1-chome, Tamatsukuri, Chuo-ku  
Osaka 540-8585, Japan  
Phone: (06) 6764-3555  
<http://www.kyoceramita.com>

