

brother®

USER'S GUIDE

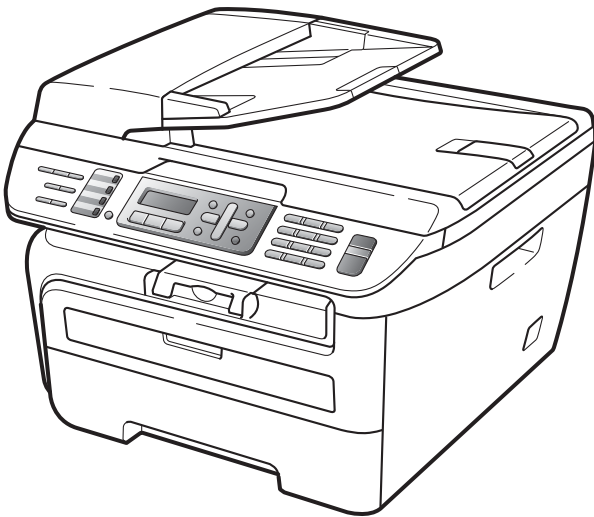

MFC-7320
MFC-7440N
MFC-7840W

If you need to call Customer Service

Please complete the following information for future reference:

Model Number: MFC-7320, MFC-7440N and MFC-7840W
(Circle your model number)

Serial Number: ¹ _____

Date of Purchase: _____

Place of Purchase: _____

¹ **The serial number is on the back of the unit. Retain this User's Guide with your sales receipt as a permanent record of your purchase, in the event of theft, fire or warranty service.**

Register your product on-line at

<http://www.brother.com/registration/>

By registering your product with Brother, you will be recorded as the original owner of the product. Your registration with Brother:

- may serve as confirmation of the purchase date of your product should you lose your receipt; and
- may support an insurance claim by you in the event of product loss covered by insurance.

Approval Information and Compilation and Publication Notice

THIS EQUIPMENT IS DESIGNED TO WORK WITH A TWO WIRE ANALOGUE PSTN LINE FITTED WITH THE APPROPRIATE CONNECTOR.

APPROVAL INFORMATION

Brother advises that this product may not function correctly in a country other than where it was originally purchased, and does not offer any warranty in the event that this product is used on public telecommunication lines in other countries.

Compilation and Publication Notice

Under the supervision of Brother Industries Ltd., this manual has been compiled and published, covering the latest product descriptions and specifications.

The contents of this manual and the specifications of this product are subject to change without notice.

Brother reserves the right to make changes without notice in the specifications and materials contained herein and shall not be responsible for any damages (including consequential) caused by reliance on the materials presented, including but not limited to typographical and other errors relating to the publication.

EC Declaration of Conformity under the R & TTE Directive



EC Declaration of Conformity

Manufacturer

Brother Industries Ltd.,
15-1, Naeshiro-cho, Mizuho-ku, Nagoya 467-8561, Japan

Plant

Brother Industries (Vietnam) Ltd.
Phuc Dien Industrial Zone Cam Phuc Commune, Cam giang Dist Hai Duong Province,
Vietnam

Herewith declare that:

Products description : Facsimile Machine
Type : Group3
Model Number : MFC-7320, MFC-7440N, MFC-7840W

are in conformity with provisions of the R & TTE Directive (1999/5/EC) and we declare compliance with the following standards :

Harmonized standards applied :

Safety EN60950-1:2001+A11: 2004

EMC EN55022: 1998 +A1: 2000 +A2: 2003 Class B
EN55024: 1998 +A1: 2001 +A2: 2003
EN61000-3-2: 2006
EN61000-3-3: 1995 +A1: 2001 +A2: 2005

Radio EN301 489-1 V1.6.1
EN301 489-17 V1.2.1
EN300 328 V1.7.1

※ Radio applies to MFC-7840W only.

Year in which CE marking was first affixed : 2007

Issued by : Brother Industries, Ltd.

Date : 31th January, 2008

Place : Nagoya, Japan

Signature :

Junji Shiota
General Manager
Quality Management Dept.
Printing & Solutions Company

Table of Contents

Section I General

1	General information	2
	Using the documentation	2
	Symbols and conventions used in the documentation	2
	Accessing the Software User's Guide and Network User's Guide (MFC-7440N and MFC-7840W only).....	2
	Viewing documentation	3
	Control panel overview	6
2	Loading paper and documents	9
	Loading paper and print media	9
	Loading paper in the paper tray.....	9
	Loading paper in the manual feed slot	10
	Unprintable area	13
	Acceptable paper and other print media	14
	Recommended paper and print media	14
	Type and size of paper	15
	Handling and using special paper	16
	Loading documents	19
	Using the automatic document feeder (ADF)	19
	Using the scanner glass	20
3	General setup	21
	Mode timer	21
	Paper settings.....	21
	Paper type	21
	Paper size.....	21
	Volume settings	22
	Ring volume.....	22
	Beeper volume	22
	Speaker volume.....	22
	Automatic daylight savings time	23
	Ecology features	23
	Toner Save	23
	Sleep time.....	23
	LCD contrast.....	23
4	Security features	24
	Security.....	24
	TX Lock (MFC-7320 and MFC-7440N only).....	24
	Secure Function Lock (MFC-7840W only)	25
	Setting lock	28
	Restricting dialling.....	29

Dial pad restriction	29
One Touch restriction	29
Speed Dial restriction	29

Section II Fax

5 Sending a fax 32

How to fax	32
Entering fax mode	32
Sending a fax from the ADF	32
Sending a fax from the scanner glass	32
Cancelling a fax in progress	33
Broadcasting	33
Cancelling a broadcast in progress	33
Additional sending operations	34
Sending faxes using multiple settings	34
Electronic cover page	34
Contrast	35
Changing fax resolution	36
Dual access	36
Real time transmission	36
Overseas mode	37
Delayed fax	37
Delayed batch transmission	37
Checking and cancelling waiting jobs	38
Sending a fax manually	38
Out of memory message	38

6 Receiving a fax 39

Receive modes	39
Choosing the receive mode	39
Using receive modes	40
Fax Only	40
Fax/Tel	40
Manual	40
External TAD	40
Receive mode settings	41
Ring delay	41
F/T ring time (Fax/Tel mode only)	41
Fax Detect	41
Setting the print density	42
Additional receiving operations	42
Printing a reduced incoming fax	42
Setting the fax receive stamp	42
Receiving faxes into memory	43
Printing a fax from the memory	43

7	Telephone and external devices	44
	Telephone line services	44
	Caller ID.....	44
	Setting the telephone line type	45
	BT call sign (U.K. only).....	46
	Connecting an external TAD	46
	Connections.....	46
	Recording an outgoing message (OGM).....	47
	Multi-line connections (PBX)	47
	External and extension telephones.....	48
	Operation from extension telephones.....	48
	For Fax/Tel mode only.....	48
	Connecting an external or extension telephone	48
	Using a non-Brother cordless external handset	50
	Using remote codes.....	50
8	Dialling and storing numbers	51
	How to dial	51
	Manual dialling.....	51
	One touch dialling.....	51
	Speed dialling	51
	Search	51
	Fax redial.....	52
	Storing numbers	52
	Storing a pause	52
	Storing one touch dial numbers.....	52
	Storing speed dial numbers.....	53
	Changing one touch and speed dial numbers	53
	Setting up groups for broadcasting.....	54
	Combining quick dial numbers	55
	Tone or pulse.....	55
9	Remote fax options	56
	Fax forwarding	56
	Fax storage.....	56
	PC fax receive	57
	Changing remote fax options.....	58
	Turning off remote fax options.....	58
	Remote retrieval	59
	Setting a remote access code	59
	Using your remote access code	59
	Retrieving fax messages	60
	Changing the fax forwarding number	60
	Remote fax commands.....	61
10	Polling	62
	Polling receive	62
	Secure polling.....	62

Delayed polling	62
Sequential polling	63
Polled transmit	63
Setup for polled transmit.....	63
Setup for polled transmit with a secure code.....	64

11 Printing reports 65

Fax reports.....	65
Transmission verification report.....	65
Fax journal.....	65
Reports.....	66
How to print a report.....	66

Section III Copy

12 Making copies 68

How to copy	68
Entering copy mode.....	68
Making a single copy	68
Making multiple copies	68
Stop copying.....	68
Copy options (temporary settings).....	69
Enlarging or reducing the image copied	69
Using the Options key	70
Improving copy quality.....	71
Sorting copies using the ADF	71
Adjusting contrast	72
Making N in 1 copies (page layout)	72
Out of memory message	73

Section IV Software

13 Software and Network (MFC-7440N and MFC-7840W only) features 76

How to read HTML User's Guide.....	76
For Windows®.....	76
For Macintosh®.....	77

Section V Appendixes

A Safety and legal 80

Choosing a location	80
Important information.....	81

Safety precautions.....	81
IEC60825-1+A2:2001 Specification	84
Disconnect device	84
Wiring information (U.K. only).....	84
LAN connection (MFC-7440N and MFC-7840W only)	85
Radio interference	85
EU Directive 2002/96/EC and EN50419.....	85
International ENERGY STAR® Compliance Statement	86
Important safety instructions.....	86
Trademarks.....	88

B Troubleshooting and routine maintenance 89

Troubleshooting	89
If you are having difficulty with your machine	89
Improving the print quality	96
Setting dial tone detection	101
Telephone line interference	102
Error and maintenance messages.....	103
Transferring your faxes or Fax Journal report	107
Document jams.....	109
Paper jams	110
Routine maintenance.....	114
Cleaning the outside of the machine	114
Cleaning the scanner glass	115
Cleaning the laser scanner window.....	116
Cleaning the corona wire.....	118
Cleaning the drum unit	120
Replacing the consumable items.....	122
Replacing a toner cartridge	122
Replacing the drum unit.....	125
Machine information	128
Checking the serial number.....	128
Checking the page counters.....	128
Checking the Drum life	128
Packing and shipping the machine	129

C Menu and features 130

On-screen programming.....	130
Menu table.....	130
Memory storage.....	130
Menu keys	130
How to access the menu mode	131
Menu table	132
Entering text	145

D Specifications 147

General.....	147
Print media.....	149
Fax.....	150

Copy	152
Scan.....	153
Print	154
Interfaces	154
Computer requirements	155
Consumable items	157
Ethernet wired network (MFC-7440N and MFC-7840W).....	158
Ethernet wireless network (MFC-7840W only)	159
Authentication and encryption for wireless users only.....	160
Wi-Fi Alliance certification	161
Wireless one-push configuration	162

E	Glossary	163
----------	-----------------	------------

F	Index	167
----------	--------------	------------



General

General information	2
Loading paper and documents	9
General setup	21
Security features	24

Using the documentation

Thank you for buying a Brother machine! Reading the documentation will help you make the most of your machine.

Symbols and conventions used in the documentation

The following symbols and conventions are used throughout the documentation.

Bold	Bold style identifies keys on the machine control panel or computer screen.
<i>Italics</i>	Italicized style emphasizes an important point or refers you to a related topic.
Courier New	Courier New font identifies the messages shown on the LCD of the machine.

 Warnings tell you what to do to prevent possible personal injury.

 Cautions specify procedures you must follow or avoid to prevent possible damage to the machine or other objects.

 Electrical Hazard icons alert you to a possible electrical shock.

 Hot Surface icons warn you not to touch machine parts that are hot.

 Incorrect setup icons alert you to devices and operations that are not compatible with the machine.

 Note icons give useful tips.

Accessing the Software User's Guide and Network User's Guide (MFC-7440N and MFC-7840W only)

This User's Guide does not contain all the information about the machine such as how to use the advanced features of Fax, Printer, Scanner, PC Fax and Network (MFC-7440N and MFC-7840W only). When you are ready to learn detailed information about these operations, read the **Software User's Guide** and **Network User's Guide** (MFC-7440N and MFC-7840W only).

Viewing documentation

Viewing documentation (Windows®)

To view the documentation, from the **Start** menu, point to **Brother, MFC-XXXX** (where XXXX is your model name) from the program group, and then click **User's Guides in HTML format**.

If you have not installed the software, you can find the documentation by following the instructions below:

- 1 Turn on your PC.
Insert the Brother CD-ROM labelled Windows® into your CD-ROM drive.
- 2 If the language selection screen appears, click your language.
- 3 If the model name screen appears, click your model name. The CD-ROM main menu will appear.



If this window does not appear, use Windows® Explorer to find and run the start.exe program from the root directory of the Brother CD-ROM.

- 4 Click **Documentation**.

- 5 Click the documentation you want to read:

- HTML documents (2 manuals):
Software User's Guide and **Network User's Guide** (MFC-7440N and MFC-7840W only) in HTML format.

This format is recommended for viewing on your computer.

- PDF documents (4 manuals):
User's Guide for stand-alone operations, **Software User's Guide**, **Network User's Guide** (MFC-7440N and MFC-7840W only) and **Quick Setup Guide**.

This format is recommended for printing the manuals. Click to go to the Brother Solutions Center, where you can view or download the PDF documents. (Internet access and PDF Reader software are required.)

How to find scanning instructions

There are several ways you can scan documents. You can find the instructions as follows:

Software User's Guide:

- Scanning a document using the TWAIN driver in Chapter 2
- Scanning a document using the WIA driver (For Windows® XP/Windows Vista® only) in Chapter 2
- Using ControlCenter3 in Chapter 3
- Network Scanning in Chapter 4 (MFC-7440N and MFC-7840W only)

ScanSoft™ PaperPort™ 11SE with OCR How-to-Guides

- The complete ScanSoft™ PaperPort™ 11SE with OCR How-to-Guides can be viewed from the Help selection in the ScanSoft™ PaperPort™ 11SE application.

Viewing documentation (Macintosh®)

- 1 Turn on your Macintosh®. Insert the Brother CD-ROM labelled Macintosh® into your CD-ROM drive.
- 2 The following window will appear.

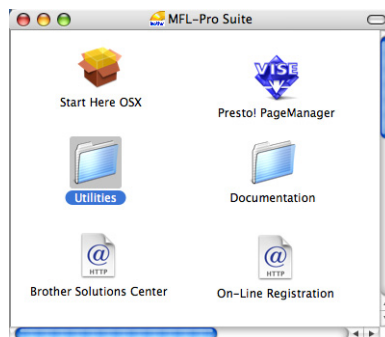

- 3 Double-click the **Documentation** icon.
- 4 If the language selection screen appears, double-click your language.
- 5 Double-click the top page file to view the **Software User's Guide** and **Network User's Guide** (MFC-7440N and MFC-7840W only) in HTML format.
- 6 Click the documentation you want to read.
 - **Software User's Guide**
 - **Network User's Guide** (MFC-7440N and MFC-7840W only)



Note

The documents are also available in PDF format (4 manuals):

User's Guide for stand-alone operations, **Software User's Guide**, **Network User's Guide** (MFC-7440N and MFC-7840W only) and **Quick Setup Guide**.

The PDF format is recommended for printing the manuals.

Double-click **Brother Solutions Center** icon to go to the Brother Solutions Center, where you can view or download the PDF documents. (Internet access and PDF Reader software are required.)

How to find scanning instructions

There are several ways you can scan documents. You can find the instructions as follows:

Software User's Guide:

- Scanning in Chapter 9
- Using ControlCenter2 in Chapter 10
- Network Scanning in Chapter 11 (MFC-7440N and MFC-7840W only)

Presto![®] PageManager[®] User's Guide:

- The complete Presto![®] PageManager[®] User's Guide can be viewed from the Help selection in the Presto![®] PageManager[®] application.

Control panel overview

MFC-7320

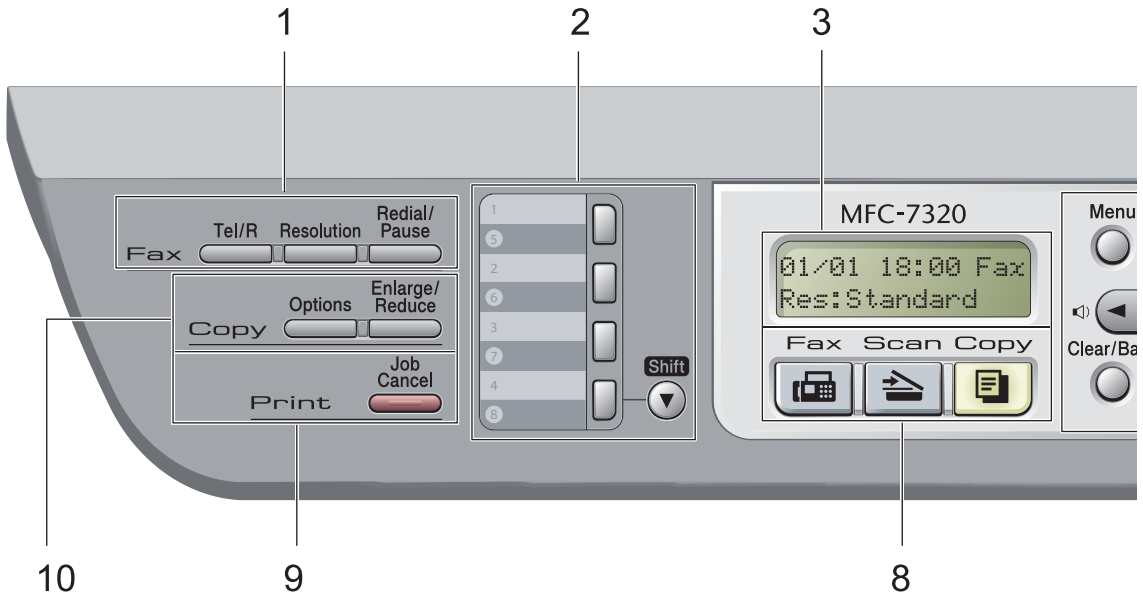

MFC-7440N and MFC-7840W have the same keys.

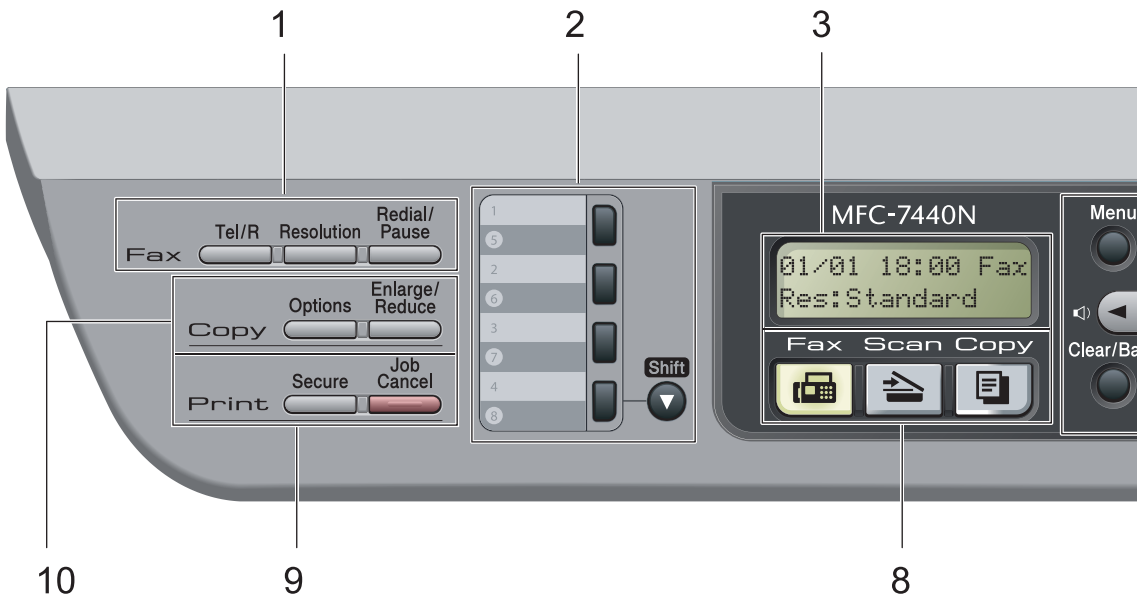

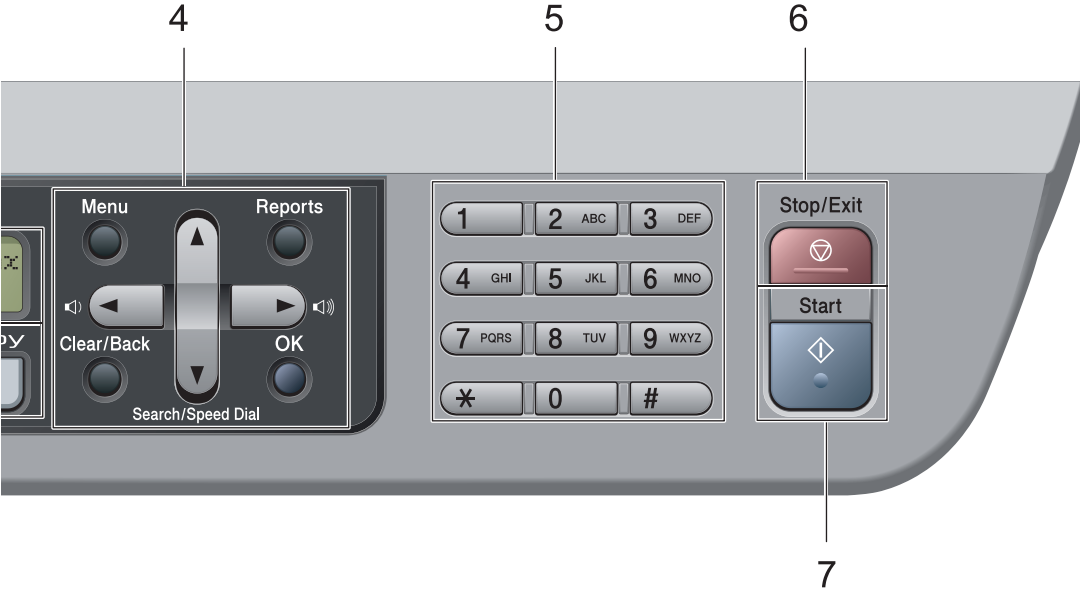
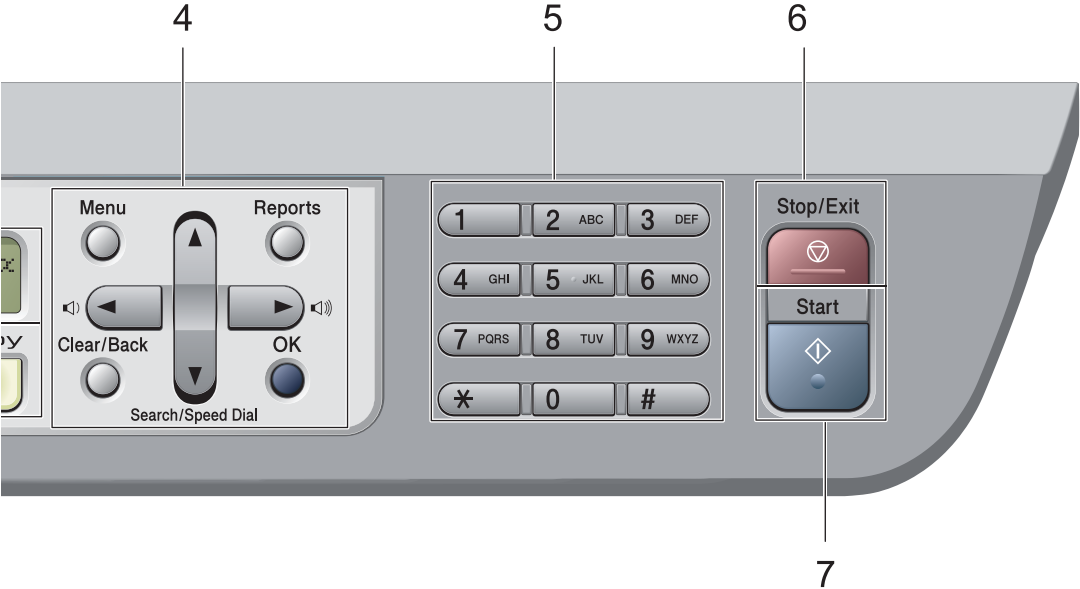

1 Fax and telephone keys:**Tel/R**

This key is used to have a telephone conversation after picking up the external handset during the F/T pseudo-ring.

When connected to a PBX, you can use this key to gain access to an outside line, to recall an operator, or to transfer a call to another extension.

Resolution

Sets the resolution when sending a fax.

Redial/Pause

Redials the last number called. It also inserts a pause when programming quick dial numbers or when dialling a number manually.

2 One Touch keys

These 4 keys give you instant access to 8 previously stored numbers.

Shift

Lets you access One Touch numbers 5 to 8 when held down.

3 LCD

Displays messages to help you set up and use your machine.

4 Menu keys:**Menu**

Lets you access the Menu to program your settings in this machine.

Clear/Back

Deletes entered data or lets you cancel the current setting.

OK

Lets you store your settings in the machine.

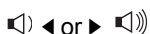
Volume keys

Press to scroll backwards or forwards through menu selections. Press to change the volume when in fax or standby mode.



Press to scroll through the menus and options.

▼ Search/Speed Dial

Lets you look up numbers that are stored in the dialling memory. It also lets you dial stored numbers by pressing a three-digit number.

Reports

Print the Transmission Verification Report, Help List, Tel Index List, Fax Journal, User Settings, Network Configuration* (*MFC-7440N and MFC-7840W only) and Order Form.

5 Dial pad

Use these keys to dial telephone and fax numbers and as a keyboard for entering information into the machine.

The # key temporarily switches the dialling mode from Pulse to Tone during a telephone call.

6 Stop/Exit

Stops an operation or exits from a menu.

7 Start

Lets you start sending faxes, making copies or scanning.

8 Mode keys:**Fax**

Puts the machine in Fax mode.

**Scan**

Puts the machine in Scan mode. (For details about scanning, see the *Software User's Guide on the CD-ROM*.)

**Copy**

Puts the machine in Copy mode.

9 Print keys:**Secure** (MFC-7440N and MFC-7840W only)

You can print data saved in memory when you enter your four-digit password. (For details about using the Secure key, see the *Software User's Guide on the CD-ROM*.)

(MFC-7840W only) When using Secure Function Lock, you can switch restricted users by holding down **Shift** as you press the **Secure** key. (See *Secure Function Lock (MFC-7840W only)* on page 25.)

Job Cancel

Cancels a programmed print job and clears it from the machine's memory.

To cancel multiple print jobs, hold down this key until the LCD shows

Job Cancel (All).

10 Copy keys:**Options**

You can quickly and easily choose temporary settings for copying.

Enlarge/Reduce

Reduces or enlarges copies.

Loading paper and print media

The machine can feed paper from the standard paper tray or manual feed slot.

When you put paper into the paper tray, note the following:

- If your application software supports paper size selection on the print menu, you can select it through the software. If your application software does not support it, you can set the paper size in the printer driver or by using the control panel buttons.
- Before using paper that has holes in it, such as organizer sheets, you must 'fan' the stack to avoid paper jams and misfeeds.



Loading paper in the paper tray

Printing on plain paper, recycled paper or transparencies from the paper tray

- 1 Pull the paper tray completely out of the machine.

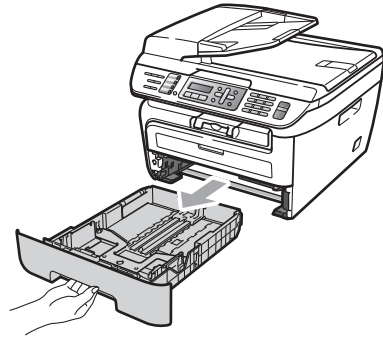

- 2 While pressing the green paper guide release lever, slide the paper guides to fit the paper size. Make sure that the guides are firmly in the slots.

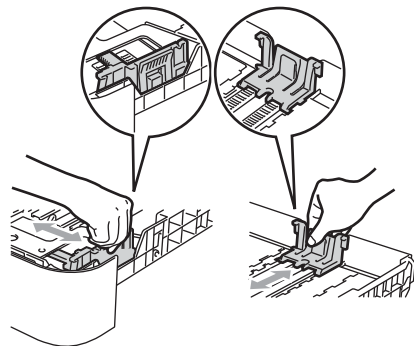

- Put paper in the tray, and make sure that the paper is below the maximum paper mark (1). The side to be printed on must be face down.

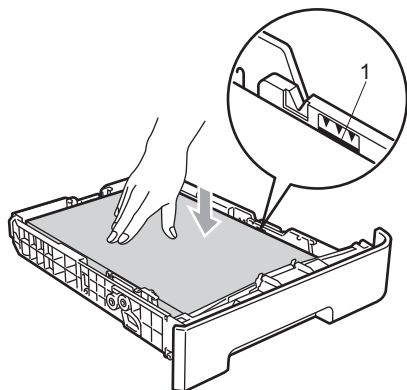

CAUTION

To prevent damage to your machine caused by paper misfeeding, make sure the paper guides touch the sides of the paper.

- Put the paper tray firmly back in the machine. Make sure that it is completely inserted into the machine.
- Fold out the support flap (1) to prevent paper from sliding off the face-down output tray.



Loading paper in the manual feed slot

You can load envelopes and special print media one at a time into this slot. Use the manual feed slot to print or copy on labels, envelopes or thicker paper.

Printing on plain paper, recycled paper or transparencies from the manual feed slot



Note

The machine automatically turns on the Manual Feed mode when you put paper in the manual feed slot.

- Lift up the support flap (1) to prevent paper from sliding off the face-down output tray, or remove each page as soon as it comes out of the machine.

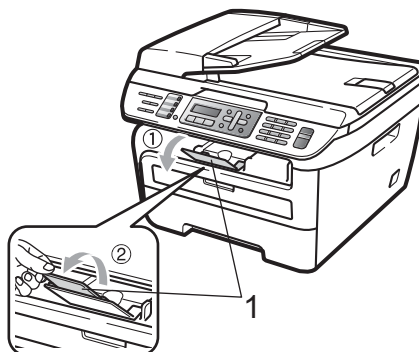

- Open the manual feed slot cover.

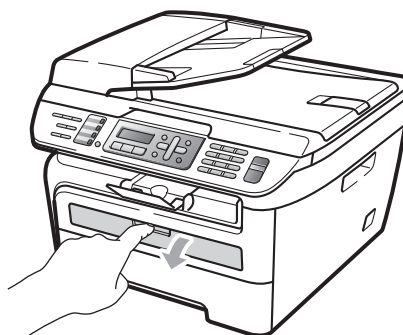

- 3 Using both hands, slide the manual feed slot paper guides to the width of the paper that you are going to use.

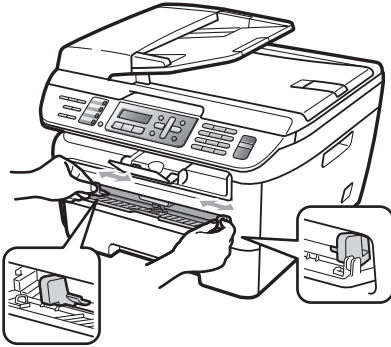

- 4 Using both hands, put one sheet of paper or one transparency in the manual feed slot until the front edge touches the paper feed roller. When you feel the machine pull in the paper, let go.



Printing on thick paper, bond paper, labels and envelopes

When the back output tray is pulled down, the machine has a straight paper path from the manual feed slot through to the back of the machine. Use this paper feed and output method when you want to print on thick paper, labels or envelopes.



Note

- Remove each printed sheet or envelope immediately to prevent a paper jam.
- The machine automatically turns on the Manual Feed mode when you put paper in the manual feed slot.

- 1 Open the back cover (back output tray).

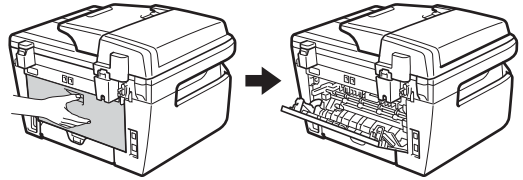

- 2 Open the manual feed slot cover.

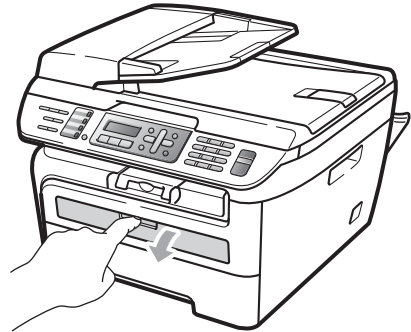

- 3 Using both hands, slide the manual feed slot paper guides to the width of the paper that you are going to use.

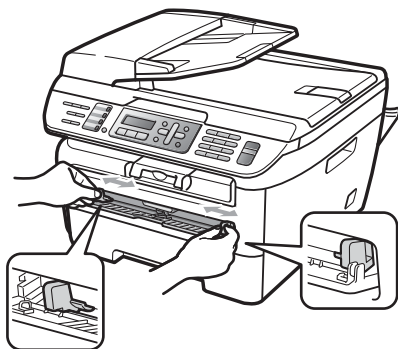

- 4 Using both hands, put one sheet of paper or one envelope in the manual feed slot until the front edge of the paper or envelope touches the paper feed roller. When you feel the machine pull in the paper, let go.

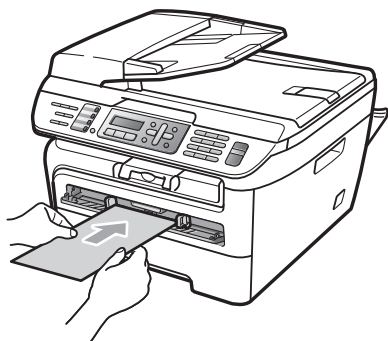
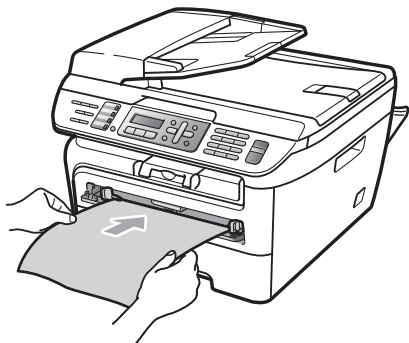

 **Note**

- Put the paper into the manual feed slot with the side to be printed face up.
- Make sure that the paper or print media (see *Acceptable paper and other print media* on page 14.) is straight and in the correct position on the manual feed slot. If it is not, the paper or the transparency may not be fed correctly, resulting in a skewed printout or a paper jam.
- Do not put more than one sheet of paper in the manual feed slot at any one time, as it may cause a jam.
- If you put any print media in the manual feed slot before the machine is in the Ready state, the print media may be ejected without being printed on.
- To easily remove a small printout from the output tray, lift up the scanner cover by using both hands as shown in the illustration.

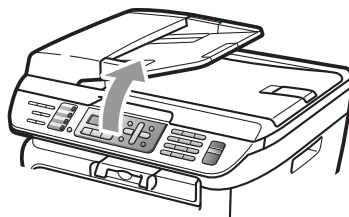

- You can still use the machine while the scanner cover is up. To close the scanner cover, push it down with both hands.

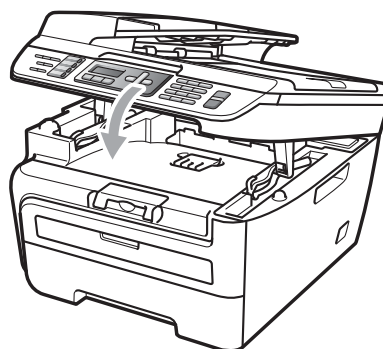

Unprintable area

Unprintable area for faxes and copies

The printable area of your machine begins at approximately 3 mm from the top and bottom and 2 mm from both sides of the paper.

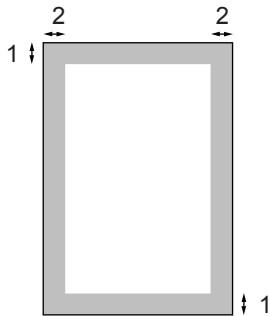

1 3 mm

2 2 mm



Note

(For copies) The unprintable area shown above is for a single copy or a 1 in 1 copy using A4 size paper. The unprintable area changes with the paper size.

Unprintable area when printing from a computer

When using the printer driver the printable area is smaller than the paper size, as shown below.

Portrait

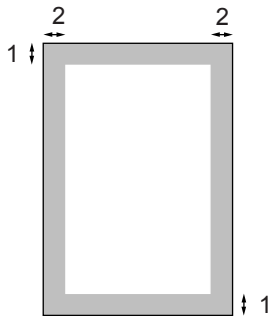

Landscape

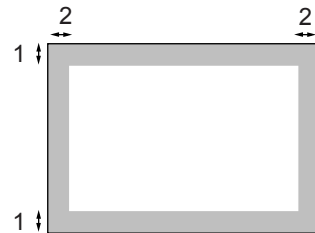

		Windows® printer driver and Macintosh® printer driver	BRScript Driver for Windows® and Macintosh® (MFC-7840W only)
Portrait	1	4.23 mm	4.23 mm
	2	6.01 mm	4.23 mm
Landscape	1	4.23 mm	4.23 mm
	2	5 mm	4.23 mm



Note

The unprintable area shown above is for A4 size paper. The unprintable area changes with the paper size.

Acceptable paper and other print media

Print quality may vary according to the type of paper you are using.

You can use the following types of print media: plain paper, bond paper, recycled paper, transparencies, labels or envelopes.

For best results, follow the instructions below:

- Use paper made for plain paper copying.
- Use paper that is 75 to 90 g/m².
- Use labels and transparencies which are designed for use in laser machines.
- Do not put different types of paper in the paper tray at the same time because it may cause paper jams or misfeeds.
- For correct printing, you must choose the same paper size from your software application as the paper in the tray.
- Avoid touching the printed surface of the paper immediately after printing.
- When you use transparencies remove each sheet immediately to prevent smudging or paper jams.
- Use long grain paper with a neutral Ph value, and a moisture content of approx 5%.

Recommended paper and print media

To get the best print quality, we suggest using the following paper.

Paper Type	Item
Plain Paper	Xerox Premier 80 g/m ²
	Xerox Business 80 g/m ²
Recycled Paper	Xerox Recycled Supreme 80g/m ²
Transparency	3M CG3300
Labels	Avery laser label L7163
Envelope	Antalis River series (DL)

Type and size of paper

The machine loads paper from the installed standard paper tray or manual feed slot.

Standard paper tray

Since the standard paper tray is a universal type, you can use any of the paper sizes (one paper type and size at a time) listed in the table in *Paper capacity of the paper trays* on page 15. The standard paper tray can hold up to 250 sheets of Letter/A4 size paper (80 g/m²). Paper can be loaded up to the maximum paper mark on the sliding paper width guide.

Manual Feed Slot

The manual feed slot can hold a sheet with a size of 76.2 to 220 mm wide and 116 to 406.4 mm long. You can use the manual feed slot if you are using special paper, envelopes or labels.

Paper capacity of the paper trays

	Paper size	Paper types	No. of sheets
Paper Tray	A4, Letter, Executive, A5, A6, B5, B6.	Plain paper and recycled paper	up to 250 [80 g/m ²]
		Transparency	up to 10
Manual Feed Slot	Width: 76.2 to 220 mm Length: 116 to 406.4 mm	Plain paper, recycled paper, bond paper, envelopes, labels and transparencies	1

Recommended paper specifications

The following paper specifications are suitable for this machine.

Basis weight	75-90 g/m ²
Thickness	80-110 µm
Roughness	Higher than 20 sec.
Stiffness	90-150 cm ³ /100
Grain direction	Long grain
Volume resistivity	10e ⁹ -10e ¹¹ ohm
Surface resistivity	10e ⁹ -10e ¹² ohm-cm
Filler	CaCO ₃ (Neutral)
Ash content	Below 23 wt%
Brightness	Higher than 80 %
Opacity	Higher than 85 %

Handling and using special paper

The machine is designed to work well with most types of xerographic and bond paper. However, some paper variables may have an effect on print quality or handling reliability. Always test samples of paper before purchasing to ensure desirable performance. Store paper in its original packaging and keep it sealed. Keep the paper flat and away from moisture, direct sunlight and heat.

Some important guidelines when selecting paper are:

- Do not use inkjet paper because it may cause a paper jam or damage your machine.
- Preprinted paper must use ink that can withstand the temperature of the machine's fusing process (200 degrees centigrade).
- If you use bond paper, paper having a rough surface or paper that is wrinkled or creased, the paper may exhibit degraded performance.

Types of paper to avoid

! CAUTION

Some types of paper may not perform well or may cause damage to your machine.

DO NOT use paper:

- that is highly textured
- that is extremely smooth or shiny
- that is curled or warped

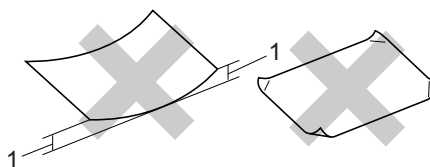

1 2 mm

- that is coated or has a chemical finish
- that is damaged, creased or folded
- that exceeds the recommended weight specification in this guide
- with tabs and staples
- with letterheads using low temperature dyes or thermography
- that is multipart or carbonless
- that is designed for inkjet printing

If you use any of the types of paper listed above, they may damage your machine. This damage is not covered under any Brother warranty or service agreement.

Envelopes

Most envelopes will be suitable for your machine. However, some envelopes may have feed and print-quality problems because of the way they have been made. A suitable envelope should have edges with straight, well-creased folds and the leading edge should not be thicker than two sheets of paper. The envelope should lie flat and not be of baggy or flimsy construction. You should buy quality envelopes from a supplier who understands that you will be using the envelopes in a laser machine.

Envelopes can be fed from the manual feed slot one at a time. We recommend that you print a test envelope to make sure the print results are what you want before you print or purchase a large quantity of envelopes.

Check the following:

- Envelopes should have a lengthwise sealing flap.
- The sealing flaps should be folded crisply and correctly (irregularly cut or folded envelopes may cause paper jams).
- Envelopes should consist of two layers of paper in the area circled in figure below.

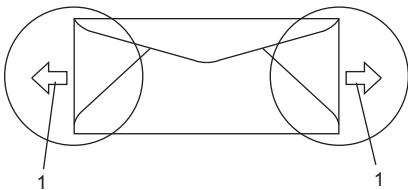

1 Feeding direction

- Envelope joints that are sealed by the manufacturer should be secure.
- We recommend that you do not print within 15 mm of the edges of envelopes.

Types of envelopes to avoid

! CAUTION

DO NOT use envelopes:

- that are damaged, curled, wrinkled or an unusual shape
- that are extremely shiny or textured
- with clasps, staples, snaps or tie strings
- with self-adhesive closures
- that are of a baggy construction
- that are not sharply creased
- that are embossed (have raised writing on them)
- that were previously printed by a laser machine
- that are pre-printed on the inside
- that cannot be arranged neatly when stacked
- that are made of paper that weighs more than the paper weight specifications for the machine
- with edges that are not straight or consistently square
- with windows, holes, cut-outs or perforations
- with glue on surface as shown in figure below

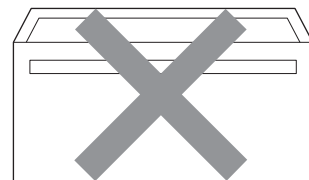

- with double flaps as shown in figure below

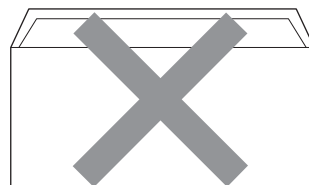

- with sealing flaps that have not been folded at purchase
- with sealing flaps as shown in figure below

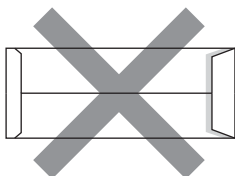

- with each side folded as shown in figure below

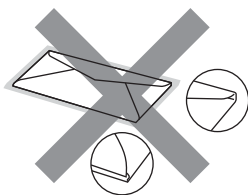

If you use any of the types of envelopes listed above, they may damage your machine. This damage is not covered under any Brother warranty or service agreement.

Occasionally you may experience paper feed problems caused by the thickness, size and flap shape of the envelopes you are using.

Labels

The machine will print on most types of labels designed for use with a laser machine. Labels should have an adhesive that is acrylic-based since this material is more stable at the high temperatures in the fuser unit. Adhesives should not come in contact with any part of the machine, because the label stock may stick to the drum unit or rollers and cause jams and print quality problems. No adhesive should be exposed between the labels. Labels should be arranged so that they cover the entire length and width of the sheet. Using labels with spaces may result in labels peeling off and causing serious jams or print problems.

All labels used in this machine must be able to withstand a temperature of 392 degrees Fahrenheit (200 degrees centigrade) for a period of 0.1 seconds.

Label sheets should not exceed the paper weight specifications described in this User's Guide. Labels exceeding this specification may not feed or print correctly and may cause damage to your machine.

Labels can be fed from the manual feed slot only.

Types of labels to avoid

Do not use labels that are damaged, curled, wrinkled or an unusual shape.

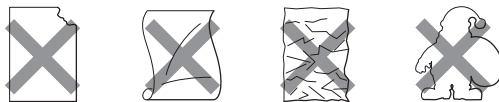

CAUTION

DO NOT feed part used label sheets. The exposed carrier sheet will damage your machine.

Loading documents

Using the automatic document feeder (ADF)

The ADF can hold up to 35 pages and feeds each sheet individually. Use standard 80 g/m² paper and always fan the pages before putting them in the ADF.

Recommended environment

Temperature: 20 to 30° C
 Humidity: 50% - 70%
 Paper: Xerox Premier 80 g/m² or Xerox Business 80 g/m²

! CAUTION

DO NOT leave thick documents on the scanner glass. If you do this, the ADF may jam.

DO NOT use paper that is curled, wrinkled, folded, ripped, stapled, paper-clipped, pasted or taped.

DO NOT use cardboard, newspaper or fabric.

To avoid damaging your machine while using the ADF, DO NOT pull on the document while it is feeding.

To scan non-standard documents see *Using the scanner glass* on page 20.

- Make sure documents written with ink are completely dry.

- Documents to be faxed must be from 148 to 215.9 mm wide and from 148 to 355.6 mm long, and of a standard weight (80 g/m²).

- 1 Unfold the ADF document output support flap (1) and the ADF support flap (2).

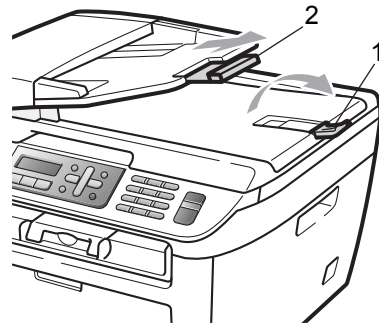

- 2 Fan the pages well.
- 3 Place your document, face up top edge first, in the ADF until you feel it touch the feed roller.
- 4 Adjust the paper guides (1) to fit the width of your document.

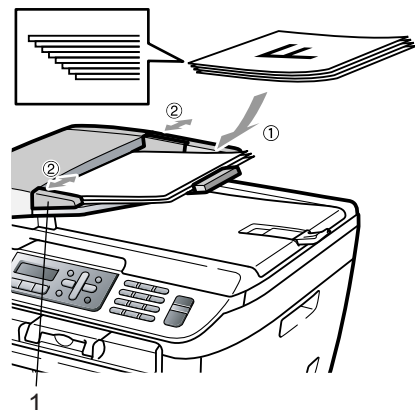

Using the scanner glass

You can use the scanner glass to fax, copy or scan pages of a book or one page at a time. Documents can be up to 215.9 mm wide and 297 mm long.

Note

To use the scanner glass, the ADF must be empty.

CAUTION

If the document is a book or is thick do not slam the cover or press on it.

- 1 Lift the document cover.
- 2 Using the document guidelines on the left, centre the document face down on the scanner glass.

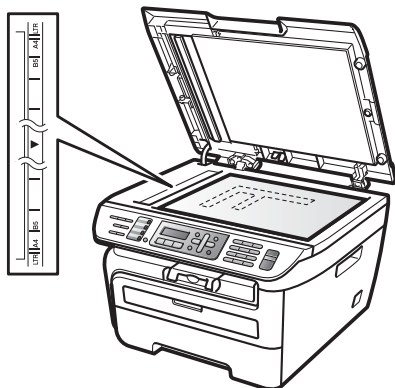

- 3 Close the document cover.

Mode timer

The machine has three mode keys on the control panel: **Fax**, **Scan**, and **Copy**.

You can set how much time the machine takes after the last Copy or Scan operation to return to Fax mode. If you choose *Off*, the machine will stay in the mode you used last.

(MFC-7840W only) Also, this setting sets the time the machine will change from individual user to public user when using Secure Function Lock. (See *Switching Users* on page 27.)



- 1 Press **Menu**, **1**, **1**.
- 2 Press **▲** or **▼** to choose 0 Sec, 30 Secs, 1 Min, 2 Mins, 5 Mins or Off. Press **OK**.
- 3 Press **Stop/Exit**.

Paper settings

Paper type

Set up the machine for the type of paper you are using. This will give you the best print quality.

- 1 Press **Menu**, **1**, **2**.
- 2 Press **▲** or **▼** to choose Thin, Plain, Thick, Thicker, Transparency or Recycled Paper. Press **OK**.
- 3 Press **Stop/Exit**.

Paper size

You can use seven sizes of paper for printing copies: A4, Letter, Executive, A5, A6, B5 and B6 and two sizes for printing faxes: A4 or Letter.

When you change the size of paper in the tray, you will also need to change the setting for paper size at the same time so your machine can fit the document or an incoming fax on the page.

- 1 Press **Menu**, **1**, **3**.
- 2 Press **▲** or **▼** to choose A4, Letter, Executive, A5, A6, B5 or B6. Press **OK**.
- 3 Press **Stop/Exit**.



Note

If you chose *Transparency* as the paper type (**Menu**, **1**, **2**) you will only be able to choose Letter or A4 size paper in Step **2**.

Volume settings

Ring volume

You can choose a ring volume level from a range of settings, from *High* to *Off*.

While in Fax mode press **◀** or **▶** to adjust the volume level. The LCD will show the current setting, and each key press will change the volume to the next level. The machine will keep the new setting until you change it.

You can also change the ring volume through the menu:

- 1 Press **Menu, 1, 4, 1**.
- 2 Press **▲** or **▼** to choose *Off, Low, Med* or *High*.
Press **OK**.
- 3 Press **Stop/Exit**.

Beeper volume

When the beeper is on, the machine will beep when you press a key, make a mistake, or after you send or receive a fax. You can choose a range of volume levels, from *High* to *Off*.

- 1 Press **Menu, 1, 4, 2**.
- 2 Press **▲** or **▼** to choose *Off, Low, Med* or *High*.
Press **OK**.
- 3 Press **Stop/Exit**.

Speaker volume

You can choose a range of speaker volume levels, from *High* to *Off*.

- 1 Press **Menu, 1, 4, 3**.
- 2 Press **▲** or **▼** to choose *Off, Low, Med* or *High*.
Press **OK**.
- 3 Press **Stop/Exit**.

Automatic daylight savings time

You can set the machine to change automatically for Daylight Savings Time. It will set itself forward one hour in the Spring, and back one hour in the Autumn.

- 1 Press **Menu 1, 5**.
- 2 Press **▲** or **▼** to choose *On* or *Off*. Press **OK**.
- 3 Press **Stop/Exit**.

Ecology features

Toner Save

You can save toner using this feature. When you set Toner Save to *On*, prints appear lighter. The default setting is *Off*.

- 1 Press **Menu, 1, 6, 1**.
- 2 Press **▲** or **▼** to choose *On* or *Off*. Press **OK**.
- 3 Press **Stop/Exit**.



Note

We do not recommend Toner Save for printing Photo or Greyscale images.

Sleep time

Setting the sleep time reduces power consumption by turning off the fuser while the machine is idle.

You can choose how long the machine must be idle (from 00 to 99 minutes) before it goes into sleep mode. When the machine receives a fax, computer data, or makes a copy, the timer will be reset. The default setting is 05 minutes.

While the machine is in sleep mode the LCD will display *Sleep*. When printing or copying in sleep mode, there will be a short delay while the fuser warms up.

- 1 Press **Menu 1, 6, 2**.
- 2 Enter the length of time the machine is idle before entering sleep mode (00 to 99). Press **OK**.
- 3 Press **Stop/Exit**.



Note

To turn *off* sleep mode, press **Start** and **Options** at the same time in 2. Press **▲** or **▼** to choose *Off*. Press **OK**.

LCD contrast

You can change the contrast to make the LCD look lighter or darker.

- 1 Press **Menu, 1, 7**.
- 2 Press **▲** to make the LCD darker. Or, press **▼** to make the LCD lighter. Press **OK**.
- 3 Press **Stop/Exit**.

Security

You can set up your machine with multiple levels of security using Setting Lock and TX Lock (MFC-7320 and MFC-7440N only) or Secure Function Lock (MFC-7840W only). You will not be able to continue to schedule Delayed Faxes or Polling jobs. However, any pre-scheduled Delayed Faxes will be sent even if you turn on TX Lock or Secure Function Lock, so they will not be lost.

TX Lock (MFC-7320 and MFC-7440N only)

TX Lock lets you prevent unauthorized access to the machine.

While TX Lock is on, the following operations are available:

- Receiving faxes
- Fax Forwarding
(if Fax Forwarding was already on)
- Remote Retrieval
(if Fax Storage was already on)
- PC Fax Receive
(if PC Fax Receive was already on)

While TX Lock is on, the following operations are NOT available:

- Sending faxes
- Copying
- PC printing
- Scanning



Note

- To print the faxes in memory, turn off TX Lock.
- If you forget the TX Lock password, please call your Brother dealer for service.

Setting up the password



Note

If you have already set the password, you will not need to set it, again.

- 1 Press **Menu, 1, 8, 1**.
- 2 Enter a four-digit number for the password using numbers 0-9. Press **OK**.
- 3 If you are entering the password for the first time, the LCD will show *Verify:.*
- 4 Re-enter the password. Press **OK**.
- 5 Press **Stop/Exit**.

Changing the TX Lock password

- 1 Press **Menu, 1, 8, 1**.
- 2 Press **▲** or **▼** to choose *Set Password*. Press **OK**.
- 3 Enter the registered four-digit password. Press **OK**.
- 4 Enter a four-digit number for the new password. Press **OK**.
- 5 If the LCD shows *Verify:.*, re-enter the new password. Press **OK**.
- 6 Press **Stop/Exit**.

Secure Function Lock (MFC-7840W only)

Secure Function Lock lets you restrict Public access to certain machine functions (Fax Tx, Fax Rx, Copy, Scan and Print ¹).

This feature also prevents users from changing the Default settings of the machine by limiting access to the Menu settings.

Disabling at least one function is required to turn on Secure Function Lock for the Public user.

Before using the security features you must first enter an administrator password.

Access to restricted operations can be enabled by creating a restricted user. Restricted users must enter a user password to use the machine.

Make a careful note of your password. If you forget it, please call your Brother dealer for service.

¹ Print includes PC-Fax Send as well as all print jobs.



Note

- You can set up to 10 individual users and one Public user.
- When you set up a Public user, you can restrict one or more of the machine's functions to all users who do not have a password.
- Only administrators can set limitations and make changes for each user.
- When Print is disabled, PC print jobs will be lost without notification.
- When Secure Function Lock is on, you can only use 1. Contrast, 6. Polled TX or 7. Coverpg Setup in the Fax menu.

If Fax Tx is disabled, you cannot use any function in the Fax menu.

- Polling Receive is enabled only when both Fax Tx and Fax Rx are enabled.

Setting the password for the administrator

The password you set in these steps is for the administrator. This password is used to set up users and to turn Secure Function Lock on or off. (See *Setting up restricted users* on page 26 and *Turning Secure Function Lock on* on page 27.)

- 1 Press **Menu, 1, 8, 1**.
- 2 Enter a four-digit number for the password using numbers 0-9. Press **OK**.
- 3 Re-enter the password when the LCD shows `Verify:.` Press **OK**.
- 4 Press **Stop/Exit**.

Changing the password for the administrator

- 1 Press **Menu, 1, 8, 1**.
- 2 Press **▲** or **▼** to choose `Set Password`. Press **OK**.
- 3 Enter the registered four-digit password. Press **OK**.
- 4 Enter a four-digit number for the new password. Press **OK**.
- 5 If the LCD shows `Verify:.`, re-enter the new password. Press **OK**.
- 6 Press **Stop/Exit**.

Setting up the Public user

You can set up the Public user. Public users do not need to enter a password.



Note

You must disable at least one function to turn on Secure Function Lock for Public user.

- 1 Press **Menu, 1, 8, 1**.
- 2 Press **▲** or **▼** to choose `Setup User`. Press **OK**.
- 3 Enter the administrator password. Press **OK**.
- 4 Press **▲** or **▼** to choose `Public`. Press **OK**.
- 5 Press **▲** or **▼** to choose `Enable` or `Disable` for `Fax Tx`. Press **OK**. After you have set `Fax Tx`, repeat this step for `Fax Rx`, `Copy`, `Scan` and `Print`. Press **OK**.



Note

You can set `Print` for only the Public user. If you disable `Print` for Public users it will also disable `Print` for all restricted users.

- 6 Press **Stop/Exit**.

Setting up restricted users

You can set up users with restrictions and a password.

- 1 Press **Menu, 1, 8, 1**.
- 2 Press **▲** or **▼** to choose `Setup User`. Press **OK**.
- 3 Enter the administrator password. Press **OK**.
- 4 Press **▲** or **▼** to choose `User01`. Press **OK**.
- 5 Use the numeric keys to enter the user name. (See *Entering text* on page 145.) Press **OK**.
- 6 Enter a four-digit password for the user. Press **OK**.
- 7 Press **▲** or **▼** to choose `Enable` or `Disable` for `Fax Tx`. Press **OK**. After you have set `Fax Tx`, repeat this step for `Fax Rx`, `Copy` and `Scan`. Press **OK**.
- 8 Repeat 4 to 7 for entering each additional user and password.
- 9 Press **Stop/Exit**.



Note

You cannot use the same password as another user's password.

Turning Secure Function Lock on/off

If you enter the wrong password when following the instructions below, the LCD will show `Wrong Password`. Re-enter the correct password.

Turning Secure Function Lock on

- 1 Press **Menu**, **1**, **8**, **1**.
- 2 Press **▲** or **▼** to choose `Lock Off-On`. Press **OK**.
- 3 Enter your four-digit administrator password. Press **OK**.

Turning Secure Function Lock off

- 1 Press **Menu**, **1**, **8**, **1**.
- 2 Press **▲** or **▼** to choose `Lock On-Off`. Press **OK**.
- 3 Enter your four-digit administrator password. Press **OK**.

Switching Users

This setting allows a restricted user to log on the machine when Secure Function Lock is turned on.



Note

After a restricted user has finished using the machine, it will return to the Public setting within the same time as the Mode Timer setting (**Menu**, **1,1**). (See *Mode timer* on page 21. Also, you can exit from an individual user by pressing the lighted Mode key.)

- 1 Hold down **Shift** as you press **Secure**.

```
Change User
PIN:XXXX
```

- 2 Enter your four-digit password. Press **OK**.

When Copy mode is disabled:

- 1 Press **Copy**  key.

```
Access Denied
```

- 2 Enter your four-digit password. Press **OK**.

When Scan mode is disabled:

- 1 Press **Scan**  key.

```
Access Denied
```

- 2 Enter your four-digit password. Press **OK**.

Setting lock

Setting Lock lets you set a password to stop other people from accidentally changing your machine settings.

Make a careful note of your password. If you forget it, please call your Brother dealer.

While Setting Lock is *On*, you cannot change the following settings without a password:

- Date/Time
- Station ID
- Quick Dial settings
- Mode Timer
- Paper Type
- Paper Size
- Volume
- Auto Daylight
- Ecology
- LCD Contrast
- Setting Lock
- Dial Restriction
- TX Lock
(MFC-7320 and MFC-7440N only)

Setting up the password

- 1 Press **Menu**, **1**, **8**, **2**.
- 2 Enter a four-digit number for the password using numbers 0-9.
Press **OK**.
- 3 Re-enter your password when the LCD shows *Verify:.*
Press **OK**.
- 4 Press **Stop/Exit**.

Changing your setting lock password

- 1 Press **Menu**, **1**, **8**, **2**.
- 2 Press **▲** or **▼** to choose *Set Password*.
Press **OK**.
- 3 Enter your four-digit password.
Press **OK**.
- 4 Enter a four-digit number for the new password.
Press **OK**.
- 5 Re-enter your new password when the LCD shows *Verify:.*
Press **OK**.
- 6 Press **Stop/Exit**.

Turning setting lock on/off

If you enter the wrong password when following the instructions below, the LCD will show *Wrong Password*. Re-enter the correct password.

Turning setting lock on

- 1 Press **Menu**, **1**, **8**, **2**.
- 2 Press **▲** or **▼** to choose *On*.
Press **OK**.
- 3 Enter your four-digit password.
Press **OK**.
- 4 Press **Stop/Exit**.

Turning setting lock off

- 1 Press **Menu**, **1**, **8**, **2**.
- 2 Enter your four-digit password.
Press **OK** twice.
- 3 Press **Stop/Exit**.

Restricting dialling

This feature is to prevent users from sending a fax or call to a wrong number by mistake. You can set the machine to restrict dialling by using the dial pad, One Touch and Speed Dial.

If you choose **Off**, the machine does not restrict the dialling method.

If you choose **Enter # twice**, the machine will prompt you to re-enter the number, and then if you re-enter the same number correctly, the machine will start dialling. If you re-enter the wrong number, the LCD will show an error message.

If you choose **On**, the machine will restrict all fax sending and outbound calls for that dialling method.

Dial pad restriction

- 1 Press **Menu, 2, 6, 1**.
- 2 Press **▲** or **▼** to choose **Off**,
Enter # twice or **On**.
Press **OK**.
- 3 Press **Stop/Exit**.

One Touch restriction

- 1 Press **Menu, 2, 6, 2**.
- 2 Press **▲** or **▼** to choose **Off**,
Enter # twice or **On**.
Press **OK**.
- 3 Press **Stop/Exit**.

Speed Dial restriction

- 1 Press **Menu, 2, 6, 3**.
- 2 Press **▲** or **▼** to choose **Off**,
Enter # twice or **On**.
Press **OK**.
- 3 Press **Stop/Exit**.



Note

- The **Enter # twice** setting will not work if you lift an external handset before entering the number. You will not be asked to re-enter the number.
- The machine cannot restrict dialling from the **Redial/Pause** key.
- If you chose **On** or **Enter # twice**, you cannot use the Broadcasting feature and cannot combine quick dial numbers when dialling.



Fax

Sending a fax	32
Receiving a fax	39
Telephone and external devices	44
Dialling and storing numbers	51
Remote fax options	56
Polling	62
Printing reports	65

5

Sending a fax

How to fax

Entering fax mode

To enter fax mode press  (Fax), and the key will glow green.

Sending a fax from the ADF

Using the ADF to send your faxes is the easiest way. To cancel a fax in progress press **Stop/Exit**.

- 1 Make sure you are in Fax mode .
- 2 Place your document *face up* in the ADF.
- 3 Dial the fax number. (See *How to dial* on page 51.)
- 4 Press **Start**.
The machine scans the pages into memory and then sends the document.



Note

If the *Out of Memory* message appears while scanning a document into memory, press **Stop/Exit** to cancel or **Start** to send the scanned pages.

Sending a fax from the scanner glass

You can use the scanner glass to fax the pages of a book, or a single page at a time. The documents can be up to Letter or A4 size. Press **Stop/Exit** to cancel a fax in progress.

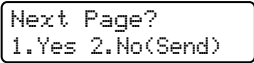
- 1 Make sure you are in Fax mode .
- 2 Place your document *face down* on the scanner glass.
- 3 Dial the fax number. (See *How to dial* on page 51.)
- 4 Press **Start**.
The machine starts scanning the first page.
- 5 After the machine scans the page, the LCD will prompt you to choose one of the options below:

- 6 Place the next page on the scanner glass, press **OK**. Repeat 5 and 6 for each additional page.

Next Page?
1.Yes 2.No(Send)

- Press **1** to send another page. Go to 6.
- Press **2** or **Start** to send the document. Go to 7.

- 6 Place the next page on the scanner glass, press **OK**. Repeat 5 and 6 for each additional page.

Set Next Page
Then Press OK

- 7 Your machine will automatically send the fax.



Note

When faxing multiple pages from the scanner glass, real time transmission should be set to *Off*. (See *Real time transmission* on page 36.)

Canceling a fax in progress

Press **Stop/Exit** to cancel the fax. If you press **Stop/Exit** while the machine is dialling or sending, the LCD will show

1. **Clear** 2. **Exit**, press **1** to cancel the fax.

Broadcasting

Broadcasting lets you send the same fax message to more than one fax number. You can include Groups, One Touch, Speed Dial numbers and up to 50 manually dialled numbers in the same broadcast.

You can broadcast up to 258 different numbers. This will depend on how many groups, access codes or credit card numbers you have stored, and on how many delayed or stored faxes in memory.



Note

Use the **Search/Speed Dial** to help you choose numbers easily.

- 1 Make sure you are in Fax mode .
- 2 Load your document.
- 3 Enter a number.
Press **OK**.
You can use either a One Touch, Speed Dial, a Group number, or a number manually entered using the dial pad. (See *How to dial* on page 51.)
- 4 Repeat 3 until you have entered all the fax numbers you want to broadcast to.
- 5 Press **Start**.

After the broadcast is finished the machine will print a broadcast report to let you know the results.

Canceling a broadcast in progress

While broadcasting you can cancel the fax currently being sent or the whole broadcast job.

- 1 Press **Menu**, **2**, **7**.
The LCD will display the fax being dialled (for example, #001 0123456789) and the broadcast job number (for example, Broadcast#001).
- 2 Press **▲** or **▼** to choose the job number you want to cancel.
Press **OK**.
- 3 Press **1** to clear the job number or **2** to exit.
If you chose to only cancel the fax currently being sent in 2, the machine will ask you if you want to cancel the broadcast. Press **1** to clear the whole broadcast job or **2** to exit.
- 4 Press **Stop/Exit**.

Additional sending operations

Sending faxes using multiple settings

Before you send a fax, you can change any combination of these settings: contrast, resolution, overseas mode, delayed fax timer, polling transmission, real time transmission or cover page settings.

- 1 Make sure you are in Fax mode . After each setting is accepted, the LCD asks if you want to enter more settings.

```
Next
1.Yes 2.No
```

- 2 Do one of the following:
 - To choose more settings, press **1**. The LCD returns to the `Setup Send` menu so you can choose another setting.
 - If you have finished choosing settings, press **2** and go to the next step for sending your fax.

Electronic cover page

This feature will *not* work unless you have already programmed your Station ID. (See *the Quick Setup Guide*.)

You can automatically send a cover page with every fax. Your cover page includes your Station ID, a comment, and the name (or number) stored in the One Touch or Speed Dial memory.

By choosing `Next Fax:On` you can also display the number of pages on the cover page.

You can choose one of the following preset comments.

- 1.Comment Off
- 2.Please Call

- 3.Urgent
- 4.Confidential

Instead of using one of the preset comments, you can enter two personal messages of your own, up to 27 characters long. Use the chart on page 145 for help entering characters.

(See *Composing your own comments* on page 34.)

- 5.(User Defined)
- 6.(User Defined)

Composing your own comments

You can set up two comments of your own.

- 1 Make sure you are in Fax mode .
- 2 Press **Menu, 2, 2, 8**.
- 3 Press **▲** or **▼** to choose 5 or 6 to store your own comment. Press **OK**.
- 4 Enter your own comment using the dial pad. Press **OK**.

Use the chart on page 145 for help entering characters.

Send a cover page for the next fax

If you want to send a cover page only for the next fax, your machine will ask you to enter the number of pages you are sending so it can be printed on the cover page.

- 1 Make sure you are in Fax mode .
- 2 Load your document.
- 3 Press **Menu, 2, 2, 7**.
- 4 Press **▲** or **▼** to choose `Next Fax:On` (or `Next Fax:Off`). Press **OK**.
- 5 Press **▲** or **▼** to choose a comment. Press **OK**.

- 6 Enter two digits to show the number of pages you are sending.
Press **OK**.
For example, enter **0, 2** for 2 pages or **0, 0** to leave the number of pages blank. If you make a mistake, press **◀** or **Clear/Back** to back up and re-enter the number of pages.

Send a cover page for all faxes

You can set the machine to send a cover page whenever you send a fax.

- 1 Make sure you are in Fax mode .
- 2 Press **Menu, 2, 2, 7**.
- 3 Press **▲** or **▼** to choose **On** (or **Off**). Press **OK**.
- 4 Press **▲** or **▼** to choose a comment. Press **OK**.

Using a printed cover page

If you want to use a printed cover page that you can write on, you can print the sample page and attach it to your fax.

- 1 Make sure you are in Fax mode .
- 2 Press **Menu, 2, 2, 7**.
- 3 Press **▲** or **▼** to choose **Print Sample**. Press **OK**.
- 4 Press **Start**.
- 5 After the machine prints a copy of your cover page, press **Stop/Exit**.

Contrast

For most documents the default setting of **Auto** will give the best results. It automatically chooses the suitable contrast for your document.

If your document is very light or dark, changing the contrast may improve the quality of the fax.

Use **Dark** to make the faxed document lighter.

Use **Light** to make the faxed document darker.

- 1 Make sure you are in Fax mode .
- 2 Load your document.
- 3 Press **Menu, 2, 2, 1**.
- 4 Press **▲** or **▼** to choose **Auto, Light** or **Dark**. Press **OK**.



Note

Even if you choose **Light** or **Dark**, the machine will send the fax using the **Auto** setting if you choose **Photo** as the Fax Resolution.

Changing fax resolution

The quality of a fax can be improved by changing the fax resolution. Resolution can be changed for the next fax *or* for all faxes.

To change the fax resolution for the next fax

- 1 Make sure you are in Fax mode .
- 2 Load your document.
- 3 Press **Resolution**, then **▲** or **▼** to choose the resolution.
Press **OK**.

To change the default fax resolution

- 1 Make sure you are in Fax mode .
- 2 Press **Menu**, **2**, **2**, **2**.
- 3 Press **▲** or **▼** to choose the resolution you want.
Press **OK**.



Note

You can choose four different resolution settings.

Standard:

Suitable for most typed documents.

Fine:

Good for small print and transmits a little slower than Standard resolution.

S.Fine:

Good for small print or artwork and transmits slower than Fine resolution.

Photo:

Use when the document has varying shades of grey or is a photograph. This has the slowest transmission time.

Dual access

You can dial a number, and start scanning the fax into memory—even when the machine is sending from memory, receiving faxes or printing PC data. The LCD will show the new job number.

The number of pages you can scan into the memory will vary depending on the data that is printed on them.



Note

If you get an **Out of Memory** message while scanning the first page of a fax, press **Stop/Exit** to cancel scanning. If you get an **Out of Memory** message while scanning a subsequent page, you can press **Start** to send the pages scanned so far, or press **Stop/Exit** to cancel the operation.

Real time transmission

When you are sending a fax, the machine will scan the documents into the memory before sending. Then, as soon as the telephone line is free, the machine will start dialling and sending.

If the memory is full, the machine will send the document in real time (even if **Real Time TX** is set to **Off**).

Sometimes, you may want to send an important document immediately, without waiting for memory transmission. You can set **Real Time TX** to **On** for all documents or **Next Fax:On** for the next fax only.



Note

In Real Time Transmission, the automatic redial feature does not work when using the scanner glass.

Sending in real time for all faxes

- 1 Make sure you are in Fax mode .
- 2 Press **Menu, 2, 2, 5**.
- 3 Press **▲** or **▼** to choose **On**.
Press **OK**.

Sending in real time for the next fax only

- 1 Make sure you are in Fax mode .
- 2 Press **Menu, 2, 2, 5**.
- 3 Press **▲** or **▼** to choose **Next Fax:On**.
Press **OK**.

Not sending in real time for the next fax only

- 1 Make sure you are in Fax mode .
- 2 Press **Menu, 2, 2, 5**.
- 3 Press **▲** or **▼** to choose **Next Fax:Off**.
Press **OK**.

Overseas mode

If you are having difficulty sending a fax overseas due to a bad connection, then turning on the overseas mode may help.

This is a temporary setting, and will only be active for your next fax.

- 1 Make sure you are in Fax mode .
- 2 Load your document.
- 3 Press **Menu, 2, 2, 9**.
- 4 Press **▲** or **▼** to choose **On** or **Off**.
Press **OK**.

Delayed fax

You can store up to 50 faxes in the memory to be sent within a twenty four hour period.

- 1 Make sure you are in Fax mode .
- 2 Load your document.
- 3 Press **Menu, 2, 2, 3**.
- 4 Enter the time you want the fax to be sent (in 24-hour format).
(For example, enter 19:45 for 7:45 PM)
Press **OK**.



Note

The number of pages you can scan into the memory depends on the amount of data printed on each page.

Delayed batch transmission

Before sending the delayed faxes, your machine will help you economize by sorting all the faxes in the memory by destination and scheduled time.

All delayed faxes that are scheduled to be sent at the same time to the same fax number will be sent as one fax to save transmission time.

- 1 Make sure you are in Fax mode .
- 2 Press **Menu, 2, 2, 4**.
- 3 Press **▲** or **▼** to choose **On** or **Off**.
Press **OK**.
- 4 Press **Stop/Exit**.

Checking and cancelling waiting jobs

Check which jobs are still waiting in the memory to be sent. If there are no jobs, the LCD will show `No Jobs Waiting`. You can cancel a fax job that is stored and waiting in the memory.

- 1 Press **Menu**, **2**, **7**.
The number of jobs still to be sent will be displayed.
- 2 Do one of the following:
 - Press **▲** or **▼** to scroll through the waiting jobs, press **OK** to choose a job, and then press **1** to cancel it.
 - Press **2** to exit without cancelling.
- 3 When you have finished, press **Stop/Exit**.

Sending a fax manually

Manual transmission

Manual transmission lets you hear the dialling, ringing and fax-receiving tones while sending a fax.

- 1 Make sure you are in Fax mode .
- 2 Load your document.
- 3 Pick up the handset of an external telephone and listen for a dial tone.
- 4 Dial the fax number you want to call.
- 5 When you hear the fax tone, press **Start**.
 - If you are using the scanner glass, press **1** to send a fax.
- 6 If you picked up the handset of an external telephone, replace it.

Out of memory message

If you get an `Out of Memory` message while scanning the first page of a fax, press **Stop/Exit** to cancel the fax.

If you get an `Out of Memory` message while scanning a subsequent page, you will have the option to press **Start** to send the pages scanned so far, or to press **Stop/Exit** to cancel the operation.



Note

If you get an `Out of Memory` message while faxing and you do not want to delete your stored faxes to clear the memory, you can send the fax in real time. (See *Real time transmission* on page 36.)

6

Receiving a fax

Receive modes

You must choose a receive mode depending on the external devices and telephone services you have on your line. The diagrams below will help you choose the correct mode. (For more detailed information about the receive modes, see *Using receive modes* on page 40.)

Choosing the receive mode

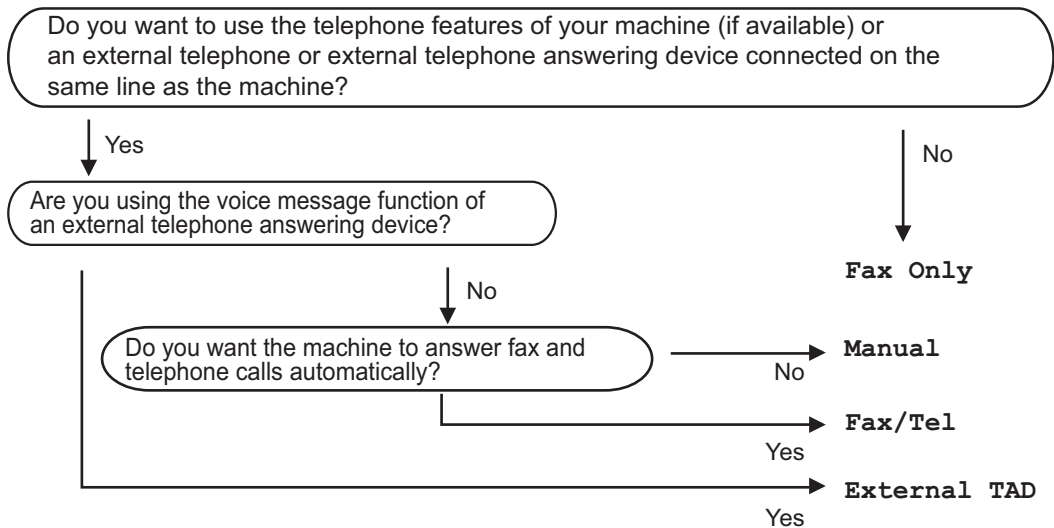

To set the receive mode follow the instructions below.

- 1 Press **Menu, 0, 1**.
- 2 Press **▲** or **▼** to choose the receive mode. Press **OK**.
- 3 Press **Stop/Exit**.

The LCD will display the current receive mode.

Using receive modes

Some receive modes answer automatically (**Fax Only** and **Fax/Tel**). You may want to change the ring delay before using these modes. (See *Ring delay* on page 41.)

Fax Only

Fax Only mode will automatically answer every call as a fax.

Fax/Tel

Fax/Tel mode helps you automatically manage incoming calls, by recognising whether they are fax or voice calls and dealing with them in one of the following ways:

- Faxes will be automatically received.
- Voice calls will start the F/T ring to tell you to pick up the line. The F/T ring is a fast double ring made by your machine.

(Also see *F/T ring time (Fax/Tel mode only)* on page 41 and *Ring delay* on page 41.)

Manual

Manual mode turns off all automatic answering functions unless you are using the **BT Call sign** ¹ feature.

¹ **BT Call Sign** is for U.K. only.

To receive a fax in **Manual** mode press **Start** when you hear fax tones (short repeating beeps). You can also use the **Fax Detect** feature to receive faxes by lifting a handset on the same line as the machine.

(Also see *Fax Detect* on page 41.)

External TAD

External TAD mode lets an external answering device manage your incoming calls. Incoming calls will be dealt with in the following ways:

- Faxes will be automatically received.
- Voice callers can record a message on the external TAD.

(For more information see *Connecting an external TAD* on page 46.)

Receive mode settings

Ring delay

The ring delay sets the number of times the machine rings before it answers in *Fax Only* and *Fax/Tel* modes.

If you have external or extension telephones on the same line as the machine choose the maximum number of rings. (See *Operation from extension telephones* on page 48 and *Fax Detect* on page 41.)

- 1 Make sure you are in Fax mode .
- 2 Press **Menu, 2, 1, 1**.
- 3 Press **▲** or **▼** to choose how many times the line rings before the machine answers.
Press **OK**.
- 4 Press **Stop/Exit**.

F/T ring time (Fax/Tel mode only)

When somebody calls your machine, you and your caller will hear the normal telephone ring sound. The number of rings is set by the ring delay setting.

If the call is a fax, then your machine will receive it; however, if it is a voice call the machine will sound the F/T ring (a fast double-ring) for the time you have set in the F/T ring time setting. If you hear the F/T ring it means that you have a voice caller on the line.

Because the F/T ring is made by the machine, extension and external telephones will *not* ring; however, you can still answer the call on any telephone. (For more information see *Using remote codes* on page 50.)

- 1 Make sure you are in Fax mode .

- 2 Press **Menu, 2, 1, 2**.
- 3 Press **▲** or **▼** to choose how long the machine will ring to alert you that you have a voice call (20, 30, 40 or 70 seconds).
Press **OK**.
- 4 Press **Stop/Exit**.

Fax Detect

Turning Fax Detect *On* allows the machine to receive fax calls automatically if you lift any handset on the same line as the machine.

When you see *Receiving* on the LCD or when you hear 'chirps' through the handset you are using, just replace the handset and your machine will receive the fax.

If this feature is set to *On*, but your machine does not connect a fax call when you lift the handset of an extension or external telephone, press ***51** on the external or extension phone. (See *Operation from extension telephones* on page 48.)



Note

- You need to turn the Remote Codes setting to *on* to use the Remote Activation code ***51**. (See *Using remote codes* on page 50.)
- If you use a modem, or send faxes from a computer, on the same line and your machine intercepts them, set *Fax Detect* to *Off*.

- 1 Make sure you are in Fax mode .
- 2 Press **Menu, 2, 1, 3**.
- 3 Press **▲** or **▼** to choose *On* or *Off*.
Press **OK**.
- 4 Press **Stop/Exit**.

Setting the print density

You can adjust the print density to make your printed pages darker or lighter.

- 1 Make sure you are in Fax mode .
- 2 Press **Menu, 2, 1, 7**.
- 3 Press **▲** to make the print darker. Or, press **▼** to make the print lighter. Press **OK**.
- 4 Press **Stop/Exit**.

Additional receiving operations

Printing a reduced incoming fax

If you choose **On**, the machine automatically reduces each page of an incoming fax to fit on one page of A4 or Letter size paper.

The machine calculates the reduction ratio by using the page size of the fax and your Paper Size setting (**Menu, 1, 3**).

- 1 Make sure you are in Fax mode .
- 2 Press **Menu, 2, 1, 5**.
- 3 Press **▲** or **▼** to choose **On** or **Off**. Press **OK**.
- 4 Press **Stop/Exit**.

Setting the fax receive stamp

You can set the machine to print the received date and time in the top centre of each received fax page.

- 1 Make sure you are in Fax mode .
- 2 Press **Menu, 2, 1, 9**.
- 3 Press **▲** or **▼** to choose **On** or **Off**. Press **OK**.
- 4 Press **Stop/Exit**.



Note

Make sure you have set the current date and time in the machine.

Receiving faxes into memory

As soon as the paper tray becomes empty during fax reception, the screen will display **No Paper**, asking you to put paper in the paper tray. (See *Loading paper and print media* on page 9.) If you are unable to put paper in the paper tray the following will happen:

If Memory Receive is On:

The machine will carry on receiving the fax, with the remaining pages being stored in memory, if enough memory is available. Further incoming faxes will also be stored into memory until the memory is full. When the memory is full the machine will stop automatically answering calls. To print the faxes, put fresh paper in the tray.

If Memory Receive is Off:

The machine will carry on receiving the fax, with the remaining pages being stored in memory, if enough memory is available. The machine will then stop automatically answering calls until fresh paper is put in the paper tray. To print the last fax you received, put fresh paper in the tray.

- 1 Make sure you are in Fax mode .
- 2 Press **Menu, 2, 1, 6**.
- 3 Use **▲** or **▼** to choose **On** or **Off**. Press **OK**.
- 4 Press **Stop/Exit**.

Printing a fax from the memory

If you are using the Fax Storage feature (**Menu, 2, 5, 1**), you can still print a fax from the memory when you are at your machine. See *Fax storage* on page 56.

- 1 Press **Menu, 2, 5, 3**.
- 2 Press **Start**.
- 3 Press **Stop/Exit**.

Telephone line services

Caller ID

The Caller ID feature lets you use the Caller ID subscriber service offered by many local telephone companies. Call your telephone company for details. This service shows the telephone number, or name if it is available, of your caller as the line rings.

After a few rings, the LCD will show the telephone number of your caller (and name, if available). Once you answer a call, the Caller ID information disappears from the LCD, but the call information stays stored in the Caller ID memory.

- You will see the number (or name) on the LCD.
- The ID `Unknown` message means the call originated outside your Caller ID service area.
- The ID `Withheld` message means the caller has intentionally blocked transmission of information.

You can print a list of the Caller ID information received by your machine. (See *Printing the Caller ID List* on page 44.)



Note

- The Caller ID service varies with different carriers. Call your local telephone company to find out about the kind of service available in your area.
- This feature may not be available in some countries.

Setting the Caller ID to On

If you have Caller ID on your line, then this function should be set to `On` to display the caller's phone number on the LCD as the telephone rings.

- 1 Press **Menu**, **2**, **0**, **3**.
- 2 Press **▲** or **▼** to choose `On` (or `Off`). Press **OK**.
- 3 Press **Stop/Exit**.

Viewing the Caller ID List

Your machine stores information for the last thirty calls in the Caller ID list. You can view or print this list. When the thirty-first call comes in to the machine, it replaces information about the first call.

- 1 Press **Menu**, **2**, **0**, **3**.
- 2 Press **▲** or **▼** to choose `Display ID`. Press **OK**.
The Caller ID of the last call will appear on the display. If no ID is stored, the beeper will sound and `No Caller ID` will appear on the display.
- 3 Press **▲** or **▼** to scroll through the Caller ID memory to choose the Caller ID you want to view, and then press **OK**.
The LCD will show the caller's number and the date and time of the call.
- 4 To finish viewing, press **Stop/Exit**.

Printing the Caller ID List

- 1 Press **Menu**, **2**, **0**, **3**.
- 2 Press **▲** or **▼** to choose `Print Report`. Press **OK**.
If no ID is stored, the beeper will sound and `No Caller ID` will appear on the LCD.

- 3 Press **Start**.
- 4 After printing has finished, press **Stop/Exit**.

Setting the telephone line type

If you are connecting the machine to a line that features a PBX or ISDN to send and receive faxes, it is necessary to change the Telephone Line Type accordingly by completing the following steps. If you are using a line that features a PBX, you can set your machine to always gain access to an outside line, or not.

- 1 Press **Menu, 0, 6**.
- 2 Press **▲** or **▼** to choose **PBX, ISDN** (or **Normal**). Press **OK**.
- 3 Do one of the following:
 - If you chose **ISDN** or **Normal**, go to 7.
 - If you chose **PBX**, go to 4.
- 4 Do one of the following:
 - If you want to change the current prefix number, press **1** and go to 6.
 - If you do not want to change the current prefix number, press **2** and go to 7.
- 5 Enter the prefix number (up to 5 digits) on the dial pad. Press **OK**.



Note

- You can use the numbers 0 to 9, #, * and !. (Press **Tel/R** to display “!”.)

You cannot use ! with any other numbers or characters.

If your telephone system requires a timed break recall, press **Tel/R** to enter the break.

- If the pulse dialling mode is on, # and * are not available to use.

- 6 Press **▲** or **▼** to choose **On** or **Always**. Press **OK**.



Note

- If you choose **On**, pressing **Tel/R** (the screen displays “!”.) will let you access an outside line.
- If you choose **Always**, you can access an outside line without pressing **Tel/R**.

- 7 Press **Stop/Exit**.

PBX and TRANSFER

The machine is initially set to **Normal**, which lets the machine connect to a standard PSTN (Public Switched Telephone Network) line. However, many offices use a central telephone system or Private Branch Exchange (PBX). Your machine can be connected to most types of PBX. The machine's recall feature supports timed break recall only (TBR). TBR will work with most PBX systems allowing you to gain access to an outside line, or transfer calls to another extension. The feature works when **Tel/R** is pressed.

BT call sign (U.K. only)

The BT Call Sign subscriber service is a way to have a separate number for your machine, it allows you to have at least two separate telephone numbers on one phone line. Each phone number has its own distinctive ringing pattern.

You can set up your machine so that it only responds to the second number.

When you set the BT Call Sign feature to ON, the receive mode is set to `Manual` automatically. `Manual` mode will not respond to incoming telephone calls, since the number you use for telephone calls will use the normal ring pattern. If you turn the feature off, your receive mode will remain on `Manual`.

To enable the machine to work with BT Call Sign

This feature will only work with your external phone.

- 1 Press **Menu**, **2**, **0**, **2**.
The screen displays the current setting.
- 2 Press **▲** or **▼** to choose `On` or `Off`.
Press **OK**.
- 3 Press **Stop/Exit**.

Connecting an external TAD

You can connect an external Telephone Answering Device (TAD) to the same line as your machine. When the TAD answers a call, your machine will “listen” for the CNG (fax calling) tones sent by a sending fax machine. If it hears them it will take over the call and receive the fax. If it does not hear them, it will let your TAD take a voice message and the display will show `Telephone`.

The external TAD must answer within four rings (we recommend you set it to two rings). This is because your machine cannot hear the CNG tones until the external TAD has picked up the call. The sending machine will send CNG tones for only eight to ten seconds longer. We do not recommend using the toll saver feature on your external TAD if it needs more than four rings to activate it.



Note

If you have problems receiving faxes, reduce the ring delay setting on your external TAD.

Connections

The external TAD must be connected as shown in the illustration below.

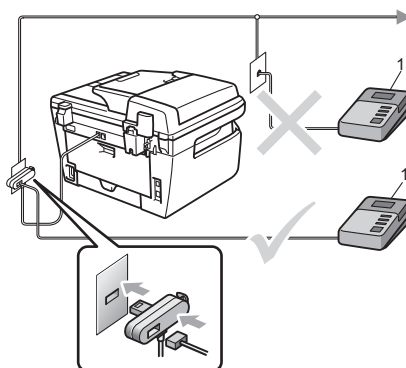

1 TAD

- 1 Set your external TAD to one or two rings. (The machine's Ring Delay setting does not apply.)
- 2 Record the outgoing message on your external TAD.
- 3 Set the TAD to answer calls.
- 4 Set the Receive Mode to External TAD. (See *Receive modes* on page 39.)

Recording an outgoing message (OGM)

- 1 Record 5 seconds of silence at the beginning of your message. This allows your machine time to listen for fax tones.
- 2 Limit your speaking to 20 seconds.
- 3 End your 20-second message by giving your Remote Activation code for people sending manual faxes. For example: "After the beep, leave a message or send a fax by pressing *51 and Start."



Note

- You need to turn the Remote Codes setting to on to use the Remote Activation code *51. (See *Using remote codes* on page 50.)
- We recommend beginning your OGM with an initial 5 second silence because the machine cannot hear fax tones over a loud voice. You may try leaving out this pause, but if your machine has trouble receiving, then you should re-record the OGM to include it.

Multi-line connections (PBX)

We suggest you ask the company who installed your PBX to connect your machine. If you have a multi line system we suggest you ask the installer to connect the unit to the last line on the system. This prevents the machine being activated each time the system receives telephone calls. If all incoming calls will be answered by a switchboard operator we recommend that you set the Receive Mode to *Manual*.

We cannot guarantee that your machine will operate properly under all circumstances when connected to a PBX. Any difficulties with sending or receiving faxes should be reported first to the company who handles your PBX.

External and extension telephones



Note

You need to turn the Remote Codes setting to on to use the Remote Activation code *51 and Remote Deactivation code #51. (See *Using remote codes* on page 50.)

Operation from extension telephones

If you answer a fax call on an extension telephone, or an external telephone that is correctly connected to the machine into the correct socket on the machine, you can make your machine take the call by using the Remote Activation code. When you press the Remote Activation code *51 the machine starts to receive the fax.

If you answer a call and no one is on the line:

You should assume that you're receiving a manual fax.

Press *51 and wait for the chirp or until the machine's LCD shows *Receiving*, and then hang up.



Note

You can also use the Fax Detect feature to make your machine tactically take the call. (See *Fax Detect* on page 41.)

For Fax/Tel mode only

When the machine is in Fax/Tel mode, it will use the F/T Ring Time (pseudo/double-ringing) to alert you to pick up a voice call.

Lift the external telephone's handset, and then press **Tel/R** to answer.

If you are at an extension telephone, you will need to lift the handset during the F/T Ring Time and then press **#51** between the pseudo/double rings. If no one is on the line, or if someone wants to send you a fax, send the call back to the machine by pressing *51.

Connecting an external or extension telephone

You can connect a separate telephone directly to your machine as shown in the diagram below.

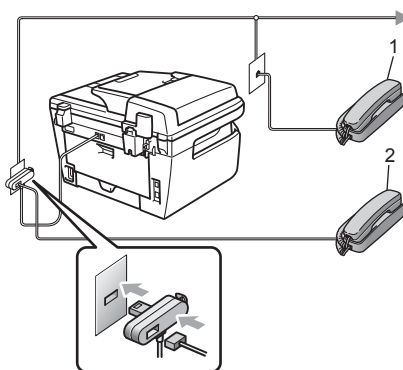

1 Extension telephone

2 External telephone

When you are using an external telephone, the LCD shows *Telephone*.

Using extension telephones (U.K. only)

Your premises may already be wired with parallel extension telephones (those connected to sockets in other rooms in the building), or perhaps you intend to add extension telephones to your line. While the simplest arrangement is a parallel connection, there are some reasons why this arrangement may cause problems.

The most common problem, is someone picking up an extension telephone while the machine is trying to send a fax.

Such problems can easily be eliminated, if you arrange modification of your extension wiring circuit, such that extension devices are connected “downstream” of your machine, in a master/slave configuration (see *figure 2*). In such a configuration, this machine can always detect whether a telephone is in use, so it will not attempt to seize the line during that time. This is known as “telephone off-hook detection”.

The inadvisable configuration is shown in *figure 1*, and the recommended master/slave configuration is shown in *figure 2*.

This new connection configuration can be arranged by contacting BT, Kingston upon Hull Telecommunications, your PBX maintainer or a qualified telephone installation company as appropriate. Simply explained, the extension telephone circuit should be terminated on a normal modular plug (BT 431A style), which in turn should be inserted into the modular socket of the white “T”-shaped connector provided as part of the line cord assembly.

Figure 1:

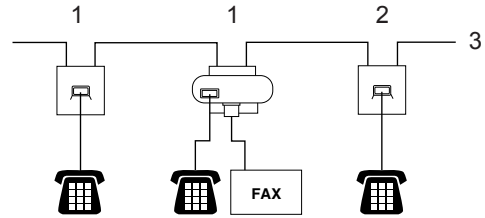

- 1 Extension socket
- 2 Master socket
- 3 Incoming line

Figure 2: Recommended connection of extension sockets

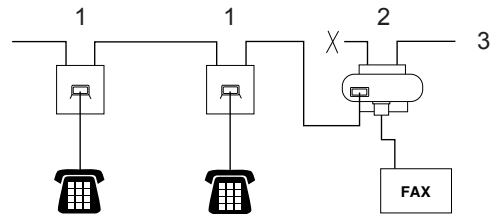

- 1 Extension socket
- 2 Master socket
- 3 Incoming line

These phones are now connected as *external devices* as shown on page 48, because they are connected to the fax machine via the T-connector.

Using a non-Brother cordless external handset

If your non-Brother cordless telephone is connected to the telephone line cord (see page 48) and you typically carry the cordless handset elsewhere, it is easier to answer calls during the Ring Delay.

If you let the machine answer first, you will have to go to the machine so you can press **Tel/R** to transfer the call to the cordless handset.

Using remote codes

Remote Activation code

If you answer a fax call on an extension or external telephone, you can tell your machine to receive it by pressing the Remote Activation code ***51**. Wait for the chirping sounds then replace the handset. (See *Fax Detect* on page 41.) Your caller will have to press start to send the fax.

Remote Deactivation code

If you receive a voice call and the machine is in F/T mode, it will start to sound the F/T (double-ring) after the initial ring delay. If you pick up the call on an extension telephone you can turn the F/T ring off by pressing **#51** (make sure you press this *between* the rings).

Turning on the remote codes

You need to turn the Remote Codes setting to on to use the Remote Activation code and Remote Deactivation code.

- 1 Make sure you are in Fax mode .
- 2 Press **Menu 2, 1, 4**.
- 3 Press **▲** or **▼** to choose **On**.
- 4 If you do not want to change the Remote Activation code, press **OK**.

- 5 If you do not want to change the Remote Deactivation code, press **OK**.
- 6 Press **Stop/Exit**.

Changing the remote codes

The preset Remote Activation code is ***51**. The preset Remote Deactivation code is **#51**. If you are always disconnected when accessing your external TAD, try changing the three-digit remote codes, for example **###** and **555**.

- 1 Make sure you are in Fax mode .
- 2 Press **Menu 2, 1, 4**.
- 3 Press **▲** or **▼** to choose **On** (or **Off**). Press **OK**.
- 4 If you chose **On** in 3, enter the new Remote Activation code. Press **OK**.
- 5 Enter the new Remote Deactivation code. Press **OK**.
- 6 Press **Stop/Exit**.

How to dial

You can dial in any of the following ways.

Manual dialling

Use the dial pad to enter all the digits of the telephone or fax number.



One touch dialling

Press the One Touch key that stores the number you want to call. (See *Storing one touch dial numbers* on page 52.)

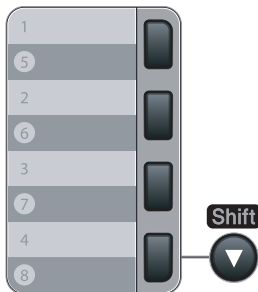

To dial One Touch numbers 5 to 8, hold down **Shift** as you press the One Touch key.

Speed dialling

Press **Search/Speed Dial**, and then the three digit Speed Dial number. (See *Storing speed dial numbers* on page 53.)



Note

If the LCD shows **Not Registered** when you enter a One Touch or a Speed Dial number, it means that a number is not stored there.

Search

You can search alphabetically for names you have stored in the One Touch and Speed Dial memories. (See *Storing one touch dial numbers* on page 52 and *Storing speed dial numbers* on page 53.)

- 1 Press **Search/Speed Dial**.
- 2 Press **▼**.
- 3 Press the dial pad key for the first few letters of the name. (Use the chart on *Entering text* on page 145 to help you enter letters.) Press **OK**.
- 4 Press **▲** or **▼** to scroll until you find the name you are looking for. Press **OK**.
- 5 Press **Start**.



Note

- If you do not enter a letter and press **OK** in 3, all registered names will appear. Press **▲** or **▼** to scroll until you find the name you are looking for.

- If the LCD shows `No Contact Found` when you enter the first few letters of the name, it means that a name for the letter is not stored.

Fax redial

If you are sending a fax automatically and the line is busy, the machine will automatically redial up to three times at five minute intervals.

If you are sending a fax manually and the line is busy, press **Redial/Pause**, wait for the other fax machine to answer, and then press **Start** to try again. If you want to make a second call to the last number dialled, you can save time by pressing **Redial/Pause** and **Start**.

Redial/Pause only works if you dialled from the control panel.

Storing numbers

You can set up your machine to do the following types of easy dialling: One Touch, Speed Dial and Groups for Broadcasting faxes. You can also specify the default resolution for each One Touch and Speed Dial number. When you dial a quick dial number, the LCD shows the name, if you stored it, or the number. A scan profile can also be stored along with the fax number.

If you lose electrical power, the quick dial numbers stored in the memory will not be lost.

A scan profile is the resolution and other scan settings that you choose when you store a number.

Storing a pause

Press **Redial/Pause** to insert a 2.8-second pause between numbers. You can press **Redial/Pause** as many times as needed to increase the length of the pause.

Storing one touch dial numbers

Your machine has 4 One Touch keys where you can store 8 fax or telephone numbers for automatic dialling. To access numbers 5 to 8, hold down **Shift** as you press the One Touch key.

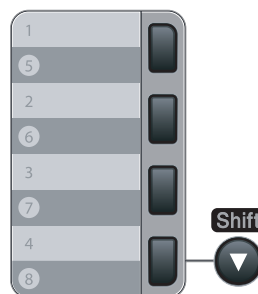

- 1 Press **Menu**, **2**, **3**, **1**.
- 2 Press the One Touch key where you want to store a number.

- 3 Enter the number (up to 20 characters). Press **OK**.
- 4 Do one of the following:
 - Enter the name using the dial pad (up to 15 characters). Press **OK**.
 - Press **OK** to store the number without a name.
- 5 Do one of the following:
 - If you want to save a fax resolution along with the number, Press **▲** or **▼** to choose *Std*, *Fine*, *S.Fine* or *Photo*. Press **OK**.
 - Press **OK** if you do not want to change the default resolution.
- 6 Do one of the following:
 - To store another One Touch number go to 2.
 - To finish storing One Touch numbers press **Stop/Exit**.
- 5 Do one of the following:
 - If you want to save a fax resolution along with the number, Press **▲** or **▼** to choose *Std*, *Fine*, *S.Fine* or *Photo*. Press **OK**.
 - Press **OK** if you do not want to change the default resolution.
- 6 Do one of the following:
 - To store another Speed Dial number go to 2.
 - To finish storing Speed Dial numbers press **Stop/Exit**.



Note

When you do a broadcast and you have saved a scan profile along with the number, the scan profile of the One Touch, Speed Dial or Group number you chose first will be applied to the broadcast.

Storing speed dial numbers

You can store your frequently used numbers as Speed Dial numbers, so that when you dial you will only have to press a few keys (**Search/Speed Dial**, the three-digit number and **Start**). The machine can store 200 Speed Dial numbers (001 - 200).

- 1 Press **Menu**, **2**, **3**, **2**.
- 2 Use the dial pad to enter a three-digit Speed Dial location number (001-200). Press **OK**.
- 3 Enter the number (up to 20 characters) Press **OK**
- 4 Do one of the following:
 - Enter the name using the dial pad (up to 15 characters). Press **OK**.
 - Press **OK** to store the number without a name.

Changing one touch and speed dial numbers

If you try to store a One Touch or Speed Dial number over an existing number, the LCD will show the name or number already stored there. If your machine has a scheduled job or you have set a fax forwarding number, the LCD will ask you if you want to change the number.

- 1 Do one of the following:
 - To change the stored number, press **1**.
 - To exit without making a change, press **2**.

#005:MIKE
1.Change 2.Exit

- 2 Enter a new number or character. Press **OK**.

- 3 Press ◀ or ▶ to position the cursor under the character you want to change, and then press **Clear/Back** to delete it. Repeat for each character you want to delete.

Setting up groups for broadcasting

If you often want to send the same fax message to many fax numbers you can set up a group.

Groups are stored on a One Touch key or a Speed Dial number. Each group uses up a One Touch key or a Speed Dial location. You can then send the fax message to all the numbers stored in a group just by pressing a One Touch key or entering a Speed Dial number, and then pressing **Start**.

Before you can add numbers to a group, you need to store them as One Touch or Speed Dial numbers. You can have up to 8 small groups, or you can assign up to 207 numbers to one large group.

- 1 Press **Menu, 2, 3, 3**.
- 2 Choose an empty location where you want to store the group in one of the following ways:
 - Press a One Touch key.
 - Press **Search/Speed Dial** and then enter the three-digit Speed Dial location.
Press **OK**.
- 3 Use the dial pad to enter a group number (01 to 08).
Press **OK**.
- 4 To add One Touch or Speed Dial numbers follow the instructions below:
 - For One Touch numbers, press the One Touch keys one after the other.

- For Speed Dial numbers, press **Search/Speed Dial**, and then enter the three-digit Speed Dial location.

The LCD will display your chosen One Touch numbers with a * and Speed Dial numbers with a # (for example *006, #009).

- 5 Press **OK** when you have finished adding numbers.
- 6 Do one of the following:
 - Enter the name using the dial pad (up to 15 characters). Use the chart on *Entering text* on page 145 to help you enter letters.
Press **OK**.
 - Press **OK** to store the group without a name.
- 7 Do one of the following:
 - If you want to save a fax resolution along with the number, Press ▲ or ▼ to choose *Std, Fine, S.Fine* or *Photo*.
Press **OK**.
 - Press **OK** if you do not want to change the default resolution.
- 8 Do one of the following:
 - To store another group for broadcasting, press **OK**. Go to 2.
 - To finish storing groups for broadcasting, press **Stop/Exit**.

Combining quick dial numbers

You can combine more than one Quick Dial number when you dial. This feature may be useful if you need to dial an access code for a cheaper rate from another long distance carrier.

For example, you might have stored '555' on Speed Dial #003 and '7000' on Speed Dial #002. You can use them both to dial '555-7000' if you press the following keys:

Press **Search/Speed Dial, 003**. Press **Search/Speed Dial, 002** and **Start**.

Numbers can be added manually by entering them on the dial pad:

Press **Search/Speed Dial, 003, 7001** (on the dial pad), and **Start**.

This would dial '555-7001'. You can also add a pause by pressing the **Redial/Pause** key.

Tone or pulse

If you have a Pulse dialling service, but need to send Tone signals (for example, for telephone banking), follow the instructions below. If you have Touch Tone service, you will not need this feature to send tone signals.

- 1 Lift the handset of the external telephone.
- 2 Press **#** on the machine's control panel. Any digits dialled after this will send tone signals. When you hang up, the machine will return to the Pulse dialling service.

9

Remote fax options

Remote fax options let you receive faxes while you are away from the machine.

You can use *only one* remote fax option at a time.

Fax forwarding

The fax forwarding feature lets you automatically forward your received faxes to another machine. If you choose Backup Print On, the machine will also print the fax.

- 1 Press **Menu**, **2**, **5**, **1**.
- 2 Press **▲** or **▼** to choose `Fax Forward`. Press **OK**.
The LCD will ask you to enter the fax number you want your faxes to be forwarded to.
- 3 Enter the forwarding number (up to 20 digits). Press **OK**.
- 4 Press **▲** or **▼** to choose `On` or `Off`. Press **OK**.

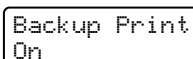

Backup Print
On

- 5 Press **Stop/Exit**.



Note

If you choose Backup Print On, the machine will also print the fax at your machine so you will have a copy. This is a safety feature in case there is a power failure before the fax is forwarded or a problem at the receiving machine. The MFC-7840W can store faxes to up to 4 days if there is a power failure. The faxes stored in the MFC-7320 or MFC-7440N memory will be deleted.

Fax storage

The fax storage feature lets you store your received faxes in the machine's memory. You can retrieve stored fax messages from a fax machine at another location using the remote retrieval commands, see *Retrieving fax messages* on page 60. Your machine will automatically print a copy of the stored fax.

- 1 Press **Menu**, **2**, **5**, **1**
- 2 Press **▲** or **▼** to choose `Fax Storage`. Press **OK**.
- 3 Press **Stop/Exit**.

PC fax receive

If you turn on the PC Fax Receive feature your machine will store received faxes in memory and send them to your PC automatically. You can then use your PC to view and store these faxes.

Even if you have turned off your PC (at night or on the weekend, for example), your machine will receive and store your faxes in its memory. The LCD will show the number of stored faxes received, for example:

PC Fax Msg:001

When you start your PC and the PC Fax Receiving software runs, your machine transfers your faxes to your PC automatically.

To transfer the received faxes to your PC you must have the PC-FAX Receiving software running on your PC. (For details, see *PC-FAX receiving* in the Software User's Guide on the CD-ROM.)

- 1 Press **Menu**, **2**, **5**, **1**.
- 2 Press **▲** or **▼** to choose PC Fax Receive.
Press **OK**.
- 3 Press **▲** or **▼** to choose <USB> or your computer name if the machine is connected to a network* (* MFC-7440N and MFC-7840W only).

```
Select ▲▼ or OK
<USB>
```

Press **OK**.

- 4 Press **▲** or **▼** to choose On or Off.

```
Backup Print
Off
```

Press **OK**.

- 5 Press **Stop/Exit**.



Note

- Before you can set up PC Fax Receive you must install the MFL-Pro Suite software on your PC. Make sure your PC is connected and turned on. (For details see *PC-FAX Receiving* in the Software User's Guide on the CD-ROM.)
- If your machine has a problem and is unable to print faxes in memory, you can use this setting to transfer your faxes to a PC. (For details, see *Error and maintenance messages* on page 103.)
- If you choose Backup Print On, the machine will also print the fax at your machine so you will have a copy. This is a safety feature in case there is a power failure before the fax is forwarded or a problem at the receiving machine. The MFC-7840W can store faxes to up to 4 days if there is a power failure. The faxes stored in the MFC-7320 or MFC-7440N memory will be deleted.
- PC Fax Receive is not supported in Mac OS. (See *PC Fax receiving* in the Software User's Guide on the CD-ROM)

Changing remote fax options

If received faxes are left in your machine's memory when you change to another remote fax option, the LCD will ask you the following message:

```
Erase All Doc?
1.Yes 2.No
```

or

```
Print All Fax?
1.Yes 2.No
```

- If you press **1**, faxes in the memory will be erased or printed before the setting changes. If a backup copy has already been printed it will not be printed again.
- If you press **2**, faxes in the memory will not be erased or printed and the setting will be unchanged.

If received faxes are left in the machine's memory when you change to PC Fax Receive from another remote fax option (Fax Forward or Fax Storage), the LCD will ask you the following message:

```
Send Fax to PC?
1.Yes 2.No
```

- If you press **1**, faxes in the memory will be sent to your PC before the setting changes.
- If you press **2**, faxes in the memory will not be erased or transferred to your PC and the setting will be unchanged.



Note

If you choose Backup Print On, the machine will also print the fax at your machine so you will have a copy. This is a safety feature in case there is a power failure before the fax is forwarded or a problem at the receiving machine. The MFC-7840W can store faxes to up to 4 days if there is a power failure. The faxes stored in the MFC-7320 or MFC-7440N memory will be deleted.

Turning off remote fax options

- 1 Press **Menu**, **2**, **5**, **1**.
- 2 Press **▲** or **▼** to choose **Off**. Press **OK**.



Note

The LCD will give you options if there are received faxes still in your machine's memory. (See *Changing remote fax options* on page 58.)

- 3 Press **Stop/Exit**.

Remote retrieval

The remote retrieval feature lets you retrieve your stored fax messages when you are not at the machine. You can call your machine from any touch tone phone or fax machine, then use the Remote Access Code to retrieve your messages.

Setting a remote access code

The remote access code lets you access the remote retrieval features when you are away from your machine. Before you use the remote access and retrieval features, you have to set up your own code. The default code is an inactive code: --*.

- 1 Press **Menu**, **2**, **5**, **2**.
- 2 Enter a three-digit code using the numbers **0 – 9**, ***** or **#**. Press **OK**.
- 3 Press **Stop/Exit**.



Note

Do not use the same code used for your Remote Activation code (***51**) or Remote Deactivation code (**#51**). (See *Changing the remote codes* on page 50.)

You can change your code at any time. If you want to make your code inactive, press **Clear/Back** and **OK** in 2 to restore the default setting --*.

Using your remote access code

- 1 Dial your fax number from a telephone or another fax machine using touch tone.
- 2 When your machine answers, immediately enter your remote access code.
- 3 The machine signals if it has received messages:
 - *No beeps*
No messages received.
 - *1 long beep*
Fax message received.
- 4 The machine gives two short beeps to tell you to enter a command. The machine will hang up if you wait longer than 30 seconds before entering a command. If you enter an invalid command the machine will beep three times.
- 5 Press **9 0** to reset the machine when you have finished.
- 6 Hang up.



Note

If your machine is set to **Manual** mode, you can still access the remote retrieval features. Dial the fax number as normal and let the machine ring. After 2 minutes you will hear a long beep to tell you to enter the remote access code. You will then have 30 seconds to enter the code.

Retrieving fax messages

- 1 Dial your fax number from a telephone or another fax machine using touch tone.
- 2 When your machine answers, immediately enter your remote access code (3 digits followed by *). If you hear one long beep, you have messages.
- 3 When you hear two short beeps, use the dial pad to press **9 6 2**.
- 4 Wait for a long beep, and then use the dial pad to enter the number of the remote fax machine where you want your fax messages sent to, followed by **##** (up to 20 digits).
- 5 Hang up after you hear your machine beep. Your machine will call the other machine, which will then print your fax messages.



Note

You can insert a pause in a fax number by using the # key.

Changing the fax forwarding number

You can change the default setting of your fax forwarding number from another telephone or fax machine using touch tone.

- 1 Dial your fax number from a telephone or another fax machine using touch tone.
- 2 When your machine answers, enter your remote access code (3 digits followed by *). If you hear one long beep, you have messages.
- 3 When you hear two short beeps, use the dial pad to press **9 5 4**.
- 4 Wait for a long beep, and then use the dial pad to enter the new number of the remote fax machine where you want your fax messages forwarded, followed by **##** (up to 20 digits).
- 5 Press **9 0** to reset the machine when you have finished.
- 6 Hang up after you hear your machine beep.



Note

You can insert a pause in a fax number by using the # key.

Remote fax commands

Follow the commands below to access features when you are away from the machine. When you call the machine and enter your Remote Access Code (3 digits followed by *), the system will give two short beeps and you must enter a remote command.

Remote commands		Operation details
95	Change the fax forwarding or fax storage settings	
	1 OFF	You can choose OFF after you have retrieved or erased all your messages.
	2 Fax forwarding	One long beep means the change is accepted. If you hear three short beeps, you cannot change because the conditions have not been met (for example, registering a fax forwarding number). You can register the maximum number of rings. (See <i>Changing the fax forwarding number</i> on page 60.) Once you have registered the number, fax forwarding will work.
	4 Fax forwarding number	
	6 Fax storage	
96	Retrieve a fax	
	2 Retrieve all faxes	Enter the number of a remote fax machine to receive stored fax messages. (See <i>Retrieving fax messages</i> on page 60.)
	3 Erase faxes from the memory	If you hear one long beep, fax messages have been erased from the memory.
97	Check the receiving status	
	1 Fax	You can check whether your machine has received any faxes. If yes, you will hear one long beep. If no, you will hear three short beeps.
98	Change the receive mode	
	1 External TAD	If you hear one long beep, your change has been accepted.
	2 Fax/Tel	
	3 Fax Only	
90	Exit	Press 9 0 to exit remote retrieval. Wait for the long beep, then replace the handset.

10

Polling

Polling lets you set up your machine so other people can receive faxes from you, but they pay for the call. It also lets you call somebody else's fax machine and receive a fax from it, so you pay for the call. The polling feature needs to be set up on both machines for this to work. Not all fax machines support polling.

Polling receive

Polling receive lets you call another fax machine to receive a fax.

- 1 Make sure you are in Fax mode .
- 2 Press **Menu, 2, 1, 8**.
- 3 Press **▲** or **▼** to choose **Standard**. Press **OK**.
- 4 Enter the fax number you are polling. Press **Start**.

Secure polling

Secure Polling lets you restrict who can get the documents you set up to be polled. Secure Polling only works with Brother fax machines. If you want to get a fax from a secured Brother machine you have to enter the secure code.

- 1 Make sure you are in Fax mode .
- 2 Press **Menu, 2, 1, 8**.
- 3 Press **▲** or **▼** to choose **Secure**. Press **OK**.
- 4 Enter a four-digit secure code. Press **OK**.
This is the security code of the fax machine you are polling.
- 5 Enter the fax number you are polling.
- 6 Press **Start**.

Delayed polling

Delayed polling lets you set the machine to begin polling receive at a later time. You can only set up *one* delayed polling operation.

- 1 Make sure you are in Fax mode .
- 2 Press **Menu, 2, 1, 8**.
- 3 Press **▲** or **▼** to choose **Timer**. Press **OK**.
- 4 Enter the time (in 24-hour format) you want to begin polling. Press **OK**.
For example, enter 21:45 for 9:45 PM.
- 5 Enter the fax number you are polling. Press **Start**.
The machine makes the polling call at the time you entered.

Sequential polling

Sequential polling lets you request documents from several fax machines in one operation.

- 1 Make sure you are in Fax mode .
- 2 Press **Menu**, **2**, **1**, **8**.
- 3 Press **▲** or **▼** to choose **Standard**, **Secure** or **Timer**. Press **OK**.
- 4 Choose one of the options below.
 - If you choose **Standard** go to 5.
 - If you choose **Secure**, enter a four-digit number, press **OK**, go to 5.
 - If you chose **Timer**, enter the time (in 24-hours format) you want to begin polling and press **OK**, go to 5.
- 5 Specify the destination fax machines you want to poll by using **One Touch**, **Speed Dial**, **Search**, a **Group** or the dial pad. You must press **OK** between each location.
- 6 Press **Start**.
The machine polls each number or group in turn for a document.

Press **Stop/Exit** while the machine is dialling to cancel the polling process.

To cancel all sequential polling receive jobs, press **Menu**, **2**, **7**. (See *Checking and cancelling waiting jobs* on page 38.)

Polled transmit

Polled transmit lets you set up your machine to wait with a document so another fax machine can call and retrieve it.

Setup for polled transmit

- 1 Make sure you are in Fax mode .
- 2 Load your document.
- 3 Press **Menu**, **2**, **2**, **6**.
- 4 Press **▲** or **▼** to choose **Standard**. Press **OK**.
- 5 Press **2** to choose **2.No** if you do not want to enter more settings when the LCD asks you the following message:

Next
 1.Yes 2.No
- 6 Press **Start**.
- 7 If you are using the scanner glass, the LCD will prompt you to choose one of the options below:

Next Page?
 1.Yes 2.No(Send)

 - Press **1** to send another page.
Go to 8.
 - Press **2** or **Start** to send the document.
- 8 Place the next page on the scanner glass, press **OK**. Repeat 7 and 8 for each additional page.
Your machine will automatically send the fax.

**Note**

The document will be stored and can be retrieved from any other fax machine until you delete the fax from memory.

To delete the fax from memory, press **Menu, 2, 7**. (See *Checking and cancelling waiting jobs* on page 38.)

Setup for polled transmit with a secure code

Secure Polling lets you restrict who can get the documents you set up to be polled. Secure Polling only works with Brother fax machines. If another person wants to retrieve a fax from your machine they will have to enter the secure code.

- 1 Make sure you are in Fax mode .
- 2 Load your document.
- 3 Press **Menu, 2, 2, 6**.
- 4 Press **▲** or **▼** to choose *Secure*. Press **OK**.
- 5 Enter a four-digit number. Press **OK**.
- 6 Press **2** to choose *2.No* if you do not want to enter more settings when the LCD asks you the following message:

```
Next
1.Yes 2.No
```

- 7 Press **Start**.
- 8 If you use the scanner glass, the LCD will prompt you to choose one of the options below:

```
Next Page?
1.Yes 2.No(Send)
```

- Press **1** to send another page.
Go to 9.
- Press **2** or **Start** to send the document.

- 9 Place the next page on the scanner glass, press **OK**. Repeat 8 and 9 for each additional page.

```
Set Next Page
Then Press OK
```

Your machine will automatically send the fax.

Fax reports

Some fax reports (transmission verification and fax journal) can be printed automatically and manually.

Transmission verification report

You can use the transmission report as proof that you sent a fax. This report lists the time and date of transmission and whether the transmission was successful (shown as "OK"). If you choose **On** or **On+Image**, the report will print for every fax you send.

If you send a lot of faxes to the same place, you may need more than the job numbers to know which faxes you must send again.

Choosing **On+Image** or **Off+Image** will print a section of the fax's first page on the report to help you remember.

When the verification report is turned **Off** or to **Off+Image**, the report will *only* print if there is a transmission error.

- 1 Press **Menu, 2, 4, 1**.
- 2 Press **▲** or **▼** to choose **On**, **On+Image**, **Off** or **Off+Image**. Press **OK**.
- 3 Press **Stop/Exit**.

Fax journal

You can set the machine to print a fax journal (activity report) at specific intervals (every 50 faxes, 6, 12 or 24 hours, 2 or 7 days). The default setting is **Every 50 Faxes**, this means that your machine will print the journal when the machine has stored 50 jobs.

If you set the interval to **Off**, you can still print the report by following the steps on the next page.

- 1 Press **Menu, 2, 4, 2**.
- 2 Press **▲** or **▼** to choose an interval. Press **OK**.
If you choose 7 days, you will be asked to choose a day when you want the 7 day countdown to begin.
- 3 Enter the time to begin printing, in 24 hour format. Press **OK**.
For example: enter 19:45 for 7:45 PM.
- 4 Press **Stop/Exit**.

If you choose 6, 12, 24 hours, 2 or 7 days, the machine will print the report at the selected time and then erase all jobs from its memory. If the machine's memory becomes full with 200 jobs before the time you chose has passed, the machine will print the journal early and then erase all jobs from memory.

If you want an extra report before it is due to print, you can print it manually without erasing the jobs from memory.

Reports

The following reports are available:

- 1 **XMIT Verify**
Displays the Transmission Verification Report for your last outgoing 200 faxes and prints the last report.
- 2 **Help List**
Prints a list of commonly used functions to help you program your machine.
- 3 **Tel Index List**
Prints a list of names and numbers stored in the One Touch and Speed Dial memory in numerical or alphabetical order.
- 4 **Fax Journal**
Prints a list of information about your last 200 incoming and outgoing faxes. (TX: transmit.) (RX: receive.)
- 5 **User Settings**
Print a list of your current settings.
- 6 **Network Config**
(MFC-7440N and MFC-7840W only)
Lists your network settings.
- 7 **Order Form**
You can print an accessories order form to fill out and send to your Brother dealer.

How to print a report

- 1 Press **Reports**.
- 2 Do one of the following:
 - Press **▲** or **▼** to choose the report you want.
Press **OK**.
 - Enter the number of the report you want to print. For example, press **2** to print the help list.
- 3 Press **Stop/Exit**.



Copy

Making copies

68

12

Making copies

How to copy

Entering copy mode

Press  (**Copy**) to enter Copy mode.

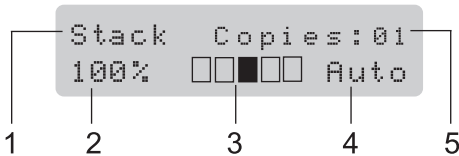

- 1 **Stack/Sort**
- 2 **Copy ratio and copy layout**
- 3 **Contrast**
- 4 **Quality**
- 5 **Number of copies**

Making a single copy

- 1 Make sure you are in Copy mode .
- 2 Load your document.
- 3 Press **Start**.

Making multiple copies

- 1 Make sure you are in Copy mode .
- 2 Load your document.
- 3 Use the dial pad to enter the number of copies (up to 99).
- 4 Press **Start**.



Note

To sort your copies, see *Sorting copies using the ADF* on page 71.

Stop copying

To stop copying, press **Stop/Exit**.

Copy options (temporary settings)

When you want to quickly change the copy settings temporarily for the next copy, use the temporary **Copy** keys. You can use different combinations.



The machine returns to its default settings one minute after copying, unless you have set the Mode Timer to 30 seconds or less. (See *Mode timer* on page 21.)

Enlarging or reducing the image copied

You can choose the following enlargement or reduction ratios:

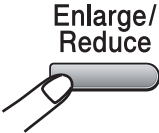
Press 	100%*
	97% LTR→A4
	94% A4→LTR
	91% Full Page
	85% LTR→EXE
	83%
	78%
	70% A4→A5
	50%
	Custom (25-400%)
	Auto
	200%
	141% A5→A4
	104% EXE→LTR

*The factory setting is shown in Bold with an asterisk.

When set to *Auto*, the machine calculates the reduction ratio that best fits the paper size the paper tray is set to. (See *Paper size* on page 21.)

Auto is only available when using the ADF.

Custom (25-400%) allows you to enter a ratio from 25% to 400%.

To enlarge or reduce the next copy follow the instructions below:

- 1 Make sure you are in Copy mode .
- 2 Load your document.
- 3 Use the dial pad to enter the number of copies (up to 99).
- 4 Press **Enlarge/Reduce**.
- 5 Do one of the following:
 - Press **▲** or **▼** to choose the enlargement or reduction ratio you want.
Press **OK**.
 - Press **▲** or **▼** to choose *Custom* (25-400%).
Press **OK**.
Use the dial pad to enter an enlargement or reduction ratio from 25% to 400%. (For example, press **5 3** to enter 53%).
Press **OK**.
- 6 Press **Start**.







Note

Page Layout Options 2 in 1(P), 2 in 1(L), 4 in 1(P) or 4 in 1(L) are *not* available with Enlarge/Reduce.

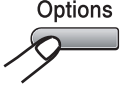
Using the Options key

Use the **Options** key to quickly set the following copy settings temporarily for the next copy.

Press	Menu selections	Options	Page
Press 	Press ▲ or ▼, then press OK 	Press ▲ or ▼, then press OK 	
	Quality	Auto* Text Photo	71
	Stack/Sort (appears when the document is in the ADF)	Stack* Sort	71
	Contrast	▼-□□□■+▲ ▼-□□□■+▲ ▼-□□■□+▲* ▼-□■□□+▲ ▼-■□□□+▲	72
	Page Layout	Off (1 in 1) * 2 in 1 (P) 2 in 1 (L) 4 in 1 (P) 4 in 1 (L)	72
 The factory settings are shown in Bold with an asterisk.			

Improving copy quality

You can choose from a range of quality settings. The default setting is `Auto`.

■ Auto

Auto is the recommended mode for ordinary printouts. Suitable for documents that contain both text and photographs.

■ Text

Suitable for documents containing only text.

■ Photo

Suitable for copying photographs.

To *temporarily* change the quality setting, follow the steps below:

- 1 Make sure you are in Copy mode .
- 2 Load your document.
- 3 Use the dial pad to enter the number of copies (up to 99).
- 4 Press **Options**.
Press **▲** or **▼** to choose `Quality`.
Press **OK**.
- 5 Press **▲** or **▼** to choose `Auto`, `Text` or `Photo`.
Press **OK**.
- 6 Press **Start**.

To change the *default* setting, follow the steps below:

- 1 Press **Menu, 3, 1**.
- 2 Press **▲** or **▼** to choose the copy quality.
Press **OK**.
- 3 Press **Stop/Exit**.

Sorting copies using the ADF

You can sort multiple copies. Pages will be stacked in the order 1 2 3, 1 2 3, 1 2 3, and so on.

- 1 Make sure you are in Copy mode .
- 2 Load your document in the ADF.
- 3 Use the dial pad to enter the number of copies (up to 99).
- 4 Press **Options** and **▲** or **▼** to choose `Stack/Sort`.
Press **OK**.
- 5 Press **▲** or **▼** to choose `Sort`.
Press **OK**.
- 6 Press **Start**.

Adjusting contrast

Contrast

Adjust the contrast to help an image look sharper and more vivid.

To *temporarily* change the contrast setting, follow the steps below:

- 1 Make sure you are in Copy mode .
- 2 Load your document.
- 3 Use the dial pad to enter the number of copies (up to 99).
- 4 Press **Options**.
Press **▲** or **▼** to choose **Contrast**.
Press **OK**.
- 5 Press **▲** or **▼** to increase or decrease the contrast.
Press **OK**.
- 6 Press **Start**.

To change the *default* setting follow the steps below:

- 1 Press **Menu**, **3**, **2**.
- 2 Press **▲** or **▼** to increase or decrease the contrast.
Press **OK**.
- 3 Press **Stop/Exit**.

Making N in 1 copies (page layout)

You can reduce the amount of paper used when copying by using the N in 1 copy feature. This allows you to copy two or four pages onto one page, which lets you save paper.

Important

- Please make sure the paper size is set to Letter or A4.
- (P) means Portrait and (L) means Landscape.
- You cannot use the Enlarge/Reduce setting with the N in 1 feature.

- 1 Make sure you are in Copy mode .
- 2 Load your document.
- 3 Use the dial pad to enter the number of copies (up to 99).
- 4 Press **Options**.
- 5 Press **▲** or **▼** to choose **Page Layout**.
Press **OK**.
- 6 Press **▲** or **▼** to choose **2 in 1 (P)**, **2 in 1 (L)**, **4 in 1 (P)**, **4 in 1 (L)** or **Off (1 in 1)**.
Press **OK**.
- 7 Press **Start** to scan the page.
If you placed the document in the ADF, the machine scans the pages and starts printing.
If you are using the scanner glass, go to 8.
- 8 After the machine scans the page, press **1** to scan the next page.

Next Page?
 1. Yes 2. No
- 9 Put the next page on the scanner glass.
Press **OK**.

Repeat ⑧ and ⑨ for each page of the layout.

- ⑩ After all the pages have been scanned, press 2 in ⑧ to finish.

If you are copying from the ADF:

Insert your document face up in the direction shown below:

■ 2 in 1 (P)



■ 2 in 1 (L)

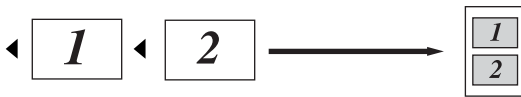

■ 4 in 1 (P)



■ 4 in 1 (L)



If you are copying from the scanner glass:

Insert your document face down in the direction shown below:

■ 2 in 1 (P)

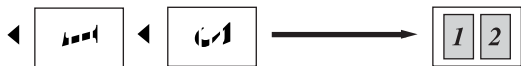

■ 2 in 1 (L)

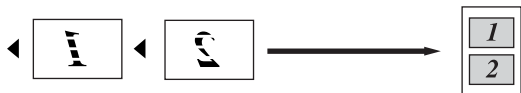

■ 4 in 1 (P)



■ 4 in 1 (L)

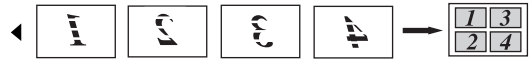

Out of memory message

If the memory becomes full while you are making copies, the LCD message will guide you through the next step.

If you get an *Out of Memory* message while scanning a subsequent page, you will have the option to press **Start** to copy the pages scanned so far, or to press **Stop/Exit** to cancel the operation.

To gain extra memory, you can do the following:

- Print the faxes that are in the memory. (See *Printing a fax from the memory* on page 43.)
- You can turn off Fax Storage. (See *Turning off remote fax options* on page 58.)

 **Note**

When you get an *Out of Memory* message, you may be able to make copies if you first print incoming faxes in the memory to restore the memory to 100%.



Software

**Software and Network (MFC-7440N and
MFC-7840W only) features**

76

13

Software and Network (MFC-7440N and MFC-7840W only) features

The User's Guide on the CD-ROM includes the **Software User's Guide** and **Network User's Guide** (MFC-7440N and MFC-7840W only) for features available when connected to a computer (for example, printing and scanning). These guides have easy to use links that, when clicked, will take you directly to a particular section.

You can find information on these features:

- Printing
- Scanning
- ControlCenter3 (for Windows®)
- ControlCenter2 (for Macintosh®)
- Remote Setup
- Faxing from your computer
- Network Faxing (MFC-7440N and MFC-7840W only)
- Network Printing (MFC-7440N and MFC-7840W only)
- Network Scanning (MFC-7440N and MFC-7840W only)
- Wireless Network Users (MFC-7840W only)



Note

See *Accessing the Software User's Guide and Network User's Guide (MFC-7440N and MFC-7840W only)* on page 2.

How to read HTML User's Guide

This is a quick reference for using the HTML User's Guide.

For Windows®



Note

If you have not installed the software, see *Chapter 1*.

- 1 From the **Start** menu, point to **Brother**, **MFC-XXXX** from the programs group, then click **User's Guides in HTML format**.
- 2 Click on the manual you want (**SOFTWARE USER'S GUIDE** or **NETWORK USER'S GUIDE** (MFC-7440N and MFC-7840W only)) from the Top Menu.

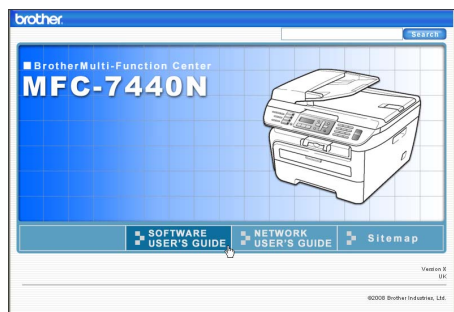

- 3 Click the heading you would like to view from the list at the left of the window.

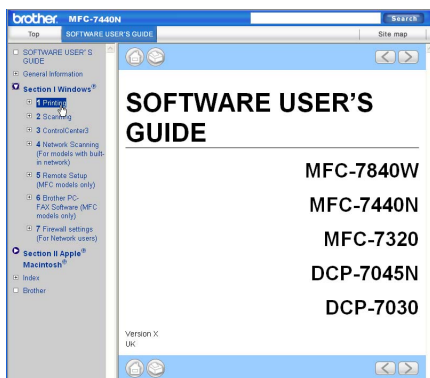

For Macintosh®

- 1 Make sure your Macintosh® is turned on. Insert the Brother CD-ROM into your CD-ROM drive.
- 2 Double-click the **Documentation** icon.
- 3 Double-click your language folder, and then double-click the top page file.
- 4 Click on the manual you want (**SOFTWARE USER'S GUIDE** or **NETWORK USER'S GUIDE** (MFC-7440N and MFC-7840W only)) in the Top Menu, and then click the heading you would like to read from the list at the left of the window.

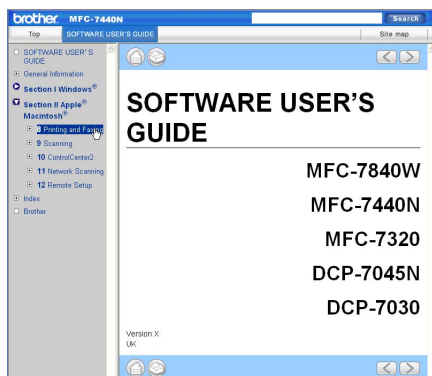



Appendixes

Safety and legal	80
Troubleshooting and routine maintenance	89
Menu and features	130
Specifications	147
Glossary	163

A

Safety and legal

Choosing a location

Place your machine on a flat, stable surface that is free of vibration. Put the machine near a telephone socket and a standard, grounded electrical socket. Choose a location where the temperature remains between 10° C and 32.5° C and the humidity is between 20% to 80% (without condensation).

- Make sure cables leading to the machine do not constitute a trip hazard.
- Avoid placing your machine on the carpet.
- Do not place near heaters, air conditioners, water, chemicals or refrigerators.
- Do not expose the machine to direct sunlight, excessive heat, moisture or dust.
- Do not connect your machine to electrical sockets controlled by wall switches or automatic timers, or to the same circuit as large appliances that might disrupt the power supply.
- Avoid sources of interference, such as speakers or the base units of cordless phones.

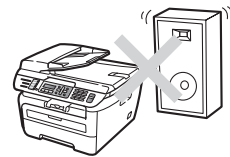
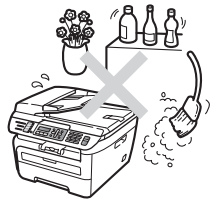
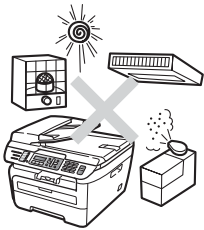

Important information

Safety precautions

Please read these instructions before attempting any maintenance, and keep them for later reference. When using your telephone equipment, follow basic safety precautions to reduce the risk of fire, electric shock or personal injury.

- DO NOT use this product near water, or in a damp environment.
- Avoid using this product during an electrical storm. There may be a remote risk of electric shock from lightning.
- We DO NOT advise using an extension lead.
- Never install telephone wiring during a lightning storm. Never install a telephone wall socket in a wet location.
- If any cables become damaged, disconnect your machine, and contact your Brother dealer.
- DO NOT place any objects on the machine, or obstruct the air vents.
- This product should be connected to an adjacent grounded AC power source within the range indicated on the rating label. DO NOT connect it to a DC power source or inverter. If you are not sure, contact a qualified electrician.
- DO NOT dispose of batteries in a fire. They may explode. Check with local codes for possible special disposal instructions.

! WARNING



Before cleaning the inside of the machine, first unplug the telephone line cord, and then the power cord from the electrical socket.

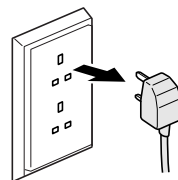

DO NOT handle the plug with wet hands. Doing this might cause an electrical shock.

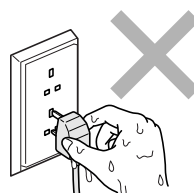

Always make sure the plug is fully inserted.



After you have just used the machine, some internal parts of the machine will be extremely hot. When you open the front or back cover of the machine, DO NOT touch the shaded parts shown in the illustration.

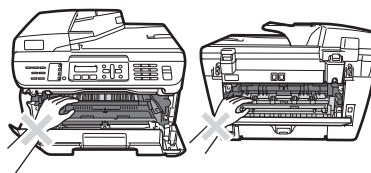

To prevent injuries, be careful not to put your hands on the edge of the machine under the document cover or scanner cover as shown in the illustrations.

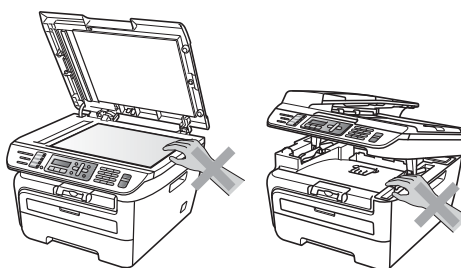

To prevent injuries, DO NOT put your fingers in the areas shown in the illustrations.

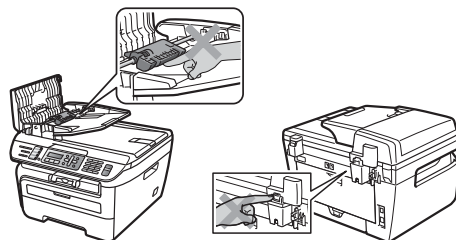



DO NOT use a vacuum cleaner to clean up scattered toner. Doing this might cause the toner dust to ignite inside the vacuum cleaner, potentially starting a fire. Please carefully clean the toner dust with a dry, lint-free cloth and dispose of it according to local regulations.



If moving your machine, use the handholds provided. First making sure to disconnect any cables.



DO NOT use any flammable substances, spray or organic solvent/liquids containing alcohol/ammonia to clean the inside or outside of the machine. Doing this may cause a fire or electrical shock. Refer to *Routine maintenance* on page 114 for how to clean the machine.



Plastic bags are used in the packaging of your machine. To avoid the danger of suffocation, keep these bags away from babies and children.



Note

The fuser unit is marked with a caution label. Please DO NOT remove or damage the label.

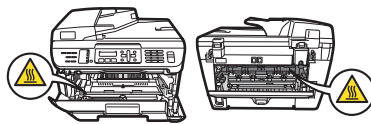

IEC60825-1+A2:2001 Specification

This machine is a Class 1 laser product as defined in IEC60825-1+A2:2001 specifications. The label shown below is attached in countries where required.

This machine has a Class 3B Laser Diode which emits invisible laser radiation in the Scanner Unit. The Scanner Unit should not be opened under any circumstances.



Internal laser radiation

Wave length: 780 - 800 nm

Output: 10 mW max.

Laser Class: Class 3B



WARNING

Use of controls, adjustments or performance of procedures other than those specified in this manual may result in hazardous radiation exposure.

Disconnect device

This product must be installed near an electrical socket that is easily accessible. In case of emergencies, you must disconnect the power cord from the electrical socket to shut off power completely.

Wiring information (U.K. only)

If you need to replace the plug fuse, fit a fuse that is approved by ASTA to BS1362 with the same rating as the original fuse.

Always replace the fuse cover. Never use a plug that does not have a cover. If in any doubt, call a qualified electrician.

Warning - This printer must be earthed.

The wires in the mains lead are coloured in line with the following code:

- Green and Yellow: Earth
- Blue: Neutral
- Brown: Live

LAN connection (MFC-7440N and MFC-7840W only)

CAUTION

DO NOT connect this product to a LAN connection that is subject to over-voltages.

Radio interference

This product complies with EN55022 (CISPR Publication 22)/Class B. When connecting the machine to a computer, ensure that you use the following interface cables.

A USB cable which must not exceed 2.0 metres in length.

EU Directive 2002/96/EC and EN50419



European
Union only

This equipment is marked with the above recycling symbol. It means that at the end of the life of the equipment you must dispose of it separately at an appropriate collection point and not place it in the normal domestic unsorted waste stream. This will benefit the environment for all.
(European Union only)

International ENERGY STAR® Compliance Statement

The purpose of the International ENERGY STAR® Program is to promote the development and popularization of energy-efficient office equipment.

As an ENERGY STAR® Partner, Brother Industries, Ltd. has determined that this product meets the ENERGY STAR® guidelines for energy efficiency.



Important safety instructions

- 1 Read all of these instructions.
- 2 Save them for later reference.
- 3 Follow all warnings and instructions marked on the product.
- 4 Unplug this product from the wall socket before cleaning inside of the machine. DO NOT use liquid or aerosol cleaners. Use a damp cloth for cleaning.
- 5 DO NOT place this product on an unstable cart, stand, or table. The product may fall, causing serious damage to the product.
- 6 Slots and openings in the casing at the back or bottom are provided for ventilation. To ensure reliable operation of the product and to protect it from overheating, these openings must not be blocked or covered. The openings should never be blocked by placing the product on a bed, sofa, rug, or other similar surface. This product should never be placed near or over a radiator or heater. This product should never be placed in a built-in installation unless adequate ventilation is provided.
- 7 This product should be connected to an AC power source within the range indicated on the rating label. DO NOT connect it to a DC power source or inverter. If you are not sure, contact a qualified electrician.
- 8 This product is equipped with a 3-wire grounded plug. This plug will only fit into a grounded power outlet. This is a safety feature. If you are unable to insert the plug into the outlet, call your electrician to replace your obsolete outlet. DO NOT defeat the purpose of the grounded plug.
- 9 Use only the power cord supplied with this machine.
- 10 DO NOT allow anything to rest on the power cord. DO NOT place this product where people can walk on the cord.

- 11 The power cord, including extensions should be no longer than 5 metres.
DO NOT share the same power circuit with other high powered appliances, such as an air conditioner, copier, shredder or similar devices. If you cannot avoid using the printer with these appliances, we recommend that you use a high-frequency noise filter.
Use a voltage regulator if the power source is not stable.
- 12 DO NOT place anything in front of the machine that will block received faxes. DO NOT place anything in the path of received faxes.
- 13 Wait until pages have exited the machine before picking them up.
- 14 Unplug this product from the power socket and refer all servicing to Brother Authorized Service Personnel under the following conditions:
 - When the power cord is damaged or frayed.
 - If liquid has been spilled into the product.
 - If the product has been exposed to rain or water.
 - If the product does not operate normally when the operating instructions are followed. Adjust only those controls that are covered by the operating instructions. Incorrect adjustment of other controls may result in damage and will often require extensive work by a qualified technician to restore the product to normal operation.
 - If the product has been dropped or the casing has been damaged.
 - If the product exhibits a distinct change in performance, indicating a need for service.
- 15 To protect your product against power surges, we recommend the use of a power protection device (Surge Protector).
- 16 To reduce the risk of fire, electric shock and injury to people, note the following:
 - DO NOT use this product near appliances that use water, a swimming pool or in a wet basement.
 - DO NOT use the machine during an electrical storm (there is the remote possibility of an electrical shock) or to report a gas leak in the vicinity of the leak.

Trademarks

The Brother logo is a registered trademark of Brother Industries, Ltd.

Brother is a registered trademark of Brother Industries, Ltd.

Multi-Function Link is a registered trademark of Brother International Corporation.

Windows Vista is either a registered trademark or a trademark of Microsoft Corporation in the United States and other countries.

Microsoft, Windows and Windows Server are registered trademarks of Microsoft Corporation in the United States and/or other countries.

Macintosh and TrueType are registered trademarks of Apple Inc.

PostScript is a registered trademark and PostScript 3 is a trademark of Adobe Systems Incorporated.

Nuance, the Nuance logo, PaperPort and ScanSoft are trademarks or registered trademarks of Nuance Communications, Inc. or its affiliates in the United States and/or other countries.

Presto! PageManager is a registered trademark of NewSoft Technology Corporation.

BROADCOM, SecureEasySetup and the SecureEasySetup logo are trademarks or registered trademarks of Broadcom Corporation in the United States and/or other countries.

AOSS is a trademark of Buffalo Inc.

Wi-Fi, WPA and WPA2 are registered trademarks and Wi-Fi Protected Setup is a trademark of Wi-Fi Alliance.

Java and all Java-based trademarks and logos are trademarks or registered trademarks of Sun Microsystems, Inc. in the United States and other countries.

Each company whose software title is mentioned in this manual has a Software Licence Agreement specific to its proprietary programs.

All other brand and product names mentioned in this User's Guide are registered trademarks of their respective companies.

Troubleshooting

If you think there is a problem with your machine, check the chart below and follow the troubleshooting tips.

Most problems can be easily resolved by yourself. If you need additional help, the Brother Solutions Center offers the latest FAQs and troubleshooting tips. Visit us at <http://solutions.brother.com/>.

If you are having difficulty with your machine

If you think there is a problem with the way your faxes look, make a copy first. If the copy looks good, the problem may not be your machine. Check the chart below and follow the troubleshooting tips.

Printing or receiving faxes

Difficulties	Suggestions
<ul style="list-style-type: none"> ■ Condensed print ■ Horizontal streaks ■ Top and bottom sentences are cut off ■ Missing lines 	Usually this is caused by a poor telephone connection. If your copy looks good, you probably had a bad connection, with static or interference on the telephone line. Ask the other party to send the fax again.
Poor print quality	See <i>Improving the print quality</i> on page 96.
Vertical black lines when receiving	The corona wire for printing may be dirty. Clean the corona wire. (See <i>Cleaning the corona wire</i> on page 118.)
	The sender's scanner may be dirty. Ask the sender to make a copy to see if the problem is with the sending machine. Try receiving from another fax machine.
	If the problem continues, call your Brother dealer for service.
Received faxes appear as split or blank pages.	If the received faxes are divided and printed on two pages or if you get an extra blank page, your paper size setting may not be correct for the paper you are using. (See <i>Paper size</i> on page 21.)
	Turn on auto reduction. (See <i>Printing a reduced incoming fax</i> on page 42.)

Telephone line or connections

Difficulties	Suggestions
Dialling does not work.	Check for a dial tone.
	Change Tone/Pulse setting. (See <i>the Quick Setup Guide</i> .)
	Check all line cord connections.
	Check that the machine is plugged in and switched on.
	If an external phone is connected to the machine, send a manual fax by lifting the handset of the external telephone and dialling the number. Wait to hear fax receiving tones before pressing Start .

Telephone line or connections (continued)

Difficulties	Suggestions
The machine does not answer when called.	Make sure the machine is in the correct receive mode for your setup. (See <i>Receiving a fax</i> on page 39.) Check for a dial tone. If possible, call your machine to hear it answer. If there is still no answer, check the telephone line cord connection. If you do not hear ringing when you call your machine, ask your telephone company to check the line.

Sending faxes

Difficulties	Suggestions
Poor sending quality.	Try changing your resolution to Fine or S.Fine . Make a copy to check your machine's scanner operation. If the copy quality is not good, clean the scanner. (See <i>Cleaning the scanner glass</i> on page 115.)
Transmission Verification Report says 'RESULT:ERROR'.	<p>There is probably temporary noise or static on the line. Try sending the fax again. If you are sending a PC Fax message and get 'RESULT:ERROR' on the Transmission Verification Report, your machine may be out of memory. To free up extra memory, you can turn off fax storage (see <i>Turning off remote fax options</i> on page 58), print fax messages in memory (see <i>Printing a fax from the memory</i> on page 43) or cancel a delayed fax or polling job (see <i>Checking and cancelling waiting jobs</i> on page 38). If the problem continues, ask the telephone company to check your telephone line.</p> <p>If you often get transmission errors due to possible interference on the telephone line, try changing the Compatibility setting to Basic (for VoIP) (For MFC-7840W, Normal or Basic (for VoIP)). (See <i>Telephone line interference</i> on page 102.)</p>
Vertical black lines when sending.	Black vertical lines on faxes you send are typically caused by dirt or correction fluid on the glass strip. (See <i>Cleaning the scanner glass</i> on page 115.)

Handling incoming calls

Difficulties	Suggestions
The machine 'Hears' a voice as a CNG Tone.	If Fax Detect is set to on, your machine is more sensitive to sounds. It may mistakenly interpret certain voices or music on the line as a fax machine calling and respond with fax receiving tones. Deactivate the machine by pressing Stop/Exit . Try avoiding this problem by turning Fax Detect to off. (See <i>Fax Detect</i> on page 41.)
Sending a Fax Call to the machine.	If you answered on an external or extension telephone, press your Remote Activation code [default setting is (* 51)]. When your machine answers, hang up.
Custom features on a single line.	<p>If you have Call Waiting, Call Waiting/Caller ID, Caller ID, Voice Mail, an answering machine, an alarm system or other custom feature on a single telephone line with your machine, it may create a problem sending or receiving faxes.</p> <p>For Example: If you subscribe to Call Waiting or some other custom service and its signal comes through the line while your machine is sending or receiving a fax, the signal can temporarily interrupt or disrupt the faxes. Brother's ECM feature should help overcome this problem. This condition is related to the telephone system industry and is common to all devices that send and receive information on a single, shared line with custom features. If avoiding a slight interruption is crucial to your business, a separate line with no custom features is recommended.</p>

Menu access difficulties

Difficulties	Suggestions
The machine beeps when you try to access the Setup Receive and Setup Send menus.	If the Fax key is not illuminated, press it to turn on Fax mode. The Setup Receive setting (Menu, 2, 1) and Setup Send setting (Menu, 2, 2) are available only when the machine is in Fax mode.

Copy quality difficulties

Difficulties	Suggestions
Vertical black line appears in copies.	Black vertical lines on copies are typically caused by dirt or correction fluid on the glass strip, or the corona wire for printing is dirty. (See <i>Cleaning the scanner glass</i> on page 115 and <i>Cleaning the corona wire</i> on page 118.)

Printing difficulties

Difficulties	Suggestions
No printout.	<ul style="list-style-type: none"> ■ Check that the machine is plugged in and the power switch is turned on. ■ Check that the toner cartridge and drum unit are installed correctly. (See <i>Replacing the drum unit</i> on page 125.) ■ Check the interface cable connection on both the machine and your computer. (See <i>the Quick Setup Guide</i>.) ■ Check that the correct printer driver has been installed and chosen. ■ Check to see if the LCD is showing an error message. (See <i>Error and maintenance messages</i> on page 103.) ■ Check the machine is online: <ul style="list-style-type: none"> (For Windows Vista®) <ul style="list-style-type: none"> Click the Start button, Control Panel, Hardware and Sound, and then Printers. Right-click Brother MFC-XXXX Printer. Make sure that Use Printer Offline is unchecked. (For Windows® XP and Windows Server® 2003) <ul style="list-style-type: none"> Click the Start button and choose Printers and Faxes. Right-click Brother MFC-XXXX Printer. Make sure that Use Printer Offline is unchecked. (For Windows® 2000) <ul style="list-style-type: none"> Click the Start button and choose Settings and then Printers. Right-click Brother MFC-XXXX Printer. Make sure that Use Printer Offline is unchecked.
The machine prints unexpectedly or it prints garbage.	<ul style="list-style-type: none"> ■ Pull out the paper tray and wait until the machine stops printing. Then turn off the machine and disconnect from the power for several minutes. (The MFC-7840W can be turned off for up to 4 days without losing faxes stored in the memory.) ■ Check the settings in your application to make sure it is set up to work with your machine.
The machine prints the first couple of pages correctly, then some pages have text missing.	<ul style="list-style-type: none"> ■ Check the settings in your application to make sure that it is set up to work with your machine. ■ Your computer is not recognising the machine's input buffer's full signal. Make sure that you connected the interface cable correctly. (See <i>the Quick Setup Guide</i>.)

Printing difficulties (continued)

Difficulties	Suggestions
The headers or footers appear when the document displays on the screen but they do not show up when it is printed.	There is an unprintable area on the top and bottom of the page. Adjust the top and bottom margins in your document to allow for this.

Scanning difficulties

Difficulties	Suggestions
TWAIN errors appear while scanning.	Make sure that the Brother TWAIN driver is chosen as the primary source. In PaperPort™ 11SE, click File, Scan or Get Photo and choose the Brother TWAIN driver .
OCR does not work.	Try increasing the scanning resolution.
Network scanning does not work. (MFC-7440N and MFC-7840W only)	See <i>Network difficulties (MFC-7440N and MFC-7840W only)</i> on page 93.

Software difficulties

Difficulties	Suggestions
Cannot install software or print.	Run the Repair MFL-Pro Suite program on the CD-ROM. This program will repair and reinstall the software.
Cannot perform '2 in 1' or '4 in 1' printing.	Check that the paper size setting in the application and in the printer driver are the same.
The machine does not print from Adobe Illustrator.	Try to reduce the print resolution. (See <i>Advanced tab in the Software User's Guide on the CD-ROM.</i>)

Paper handling difficulties

Difficulties	Suggestions
The machine does not load paper. The LCD shows No Paper or a Paper Jam message.	<ul style="list-style-type: none"> ■ If there is no paper, load a new stack of paper into the paper tray. ■ If there is paper in the paper tray, make sure it is straight. If the paper is curled, you should straighten it. Sometimes it is helpful to remove the paper, turn the stack over and put it back into the paper tray. ■ Reduce the amount of paper in the paper tray, and then try again. ■ If the LCD shows Paper Jam message and you still have a problem, see <i>Paper jams</i> on page 110.
How do I print on envelopes?	You can load envelopes from the manual feed slot. Your application must be set up to print the envelope size you are using. This is usually done in the Page Setup or Document Setup menu of your application. (See your application's manual for more information.)
Which paper can I use?	You can use plain paper, recycled paper, transparency and labels that are made for laser machines. (For details, see <i>Acceptable paper and other print media</i> on page 14.)
There is a paper jam.	(See <i>Paper jams</i> on page 110.)

Print quality difficulties

Difficulties	Suggestions
Printed pages are curled.	<ul style="list-style-type: none"> ■ Low quality thin or thick paper or not printing on the recommended side of the paper could cause this problem. Try turning over the stack of paper in the paper tray. ■ Make sure that you choose the Paper Type that suits the print media type you are using. (See <i>Acceptable paper and other print media</i> on page 14.)
Printed pages are smeared.	The Paper Type setting may be incorrect for the type of print media you are using, or the print media may be too thick or have a rough surface. (See <i>Acceptable paper and other print media</i> on page 14 and <i>Basic tab in the Software User's Guide on the CD-ROM</i> .)
Printouts are too light.	<ul style="list-style-type: none"> ■ If this problem occurs when making copies or printing received faxes, set Toner Save mode to off in the machine menu settings. (See <i>Toner Save</i> on page 23.) ■ Set Toner Save mode to off in the Advanced tab in the printer driver. (See <i>Advanced tab in the Software User's Guide on the CD-ROM</i>.)

Network difficulties (MFC-7440N and MFC-7840W only)

Difficulties	Suggestions
Cannot print over a wired Network.	<p>If you are having Network problems see <i>the Network User's Guide on the CD-ROM</i> for more information.</p> <p>Make sure your machine is powered on and is on-line and in Ready mode. Print the Network Configuration list to see your current Network settings. (See <i>How to print a report</i> on page 66.) Reconnect the LAN cable to the hub to verify that the cable and network connections are good. If possible, try connecting the machine to a different port on your hub using a different cable. If the connections are good, the lower LED of the back panel of the machine will be green.</p>



Network difficulties (MFC-7440N and MFC-7840W only) (continued)

Difficulties	Suggestions
<p>The network scanning feature does not work.</p> <p>The network PC Fax Receive feature does not work.</p> <p>The network printing feature does not work.</p>	<p>(For Windows® only) The firewall setting on your PC may be rejecting the necessary network connection. Follow the instructions below to configure Windows® Firewall. If you are using other personal firewall software, see the User's Guide for your software or contact the software manufacturer.</p> <p>For Windows® XP SP2 users:</p> <ol style="list-style-type: none"> 1 Click the Start button, Control Panel, Network and Internet Connections and then Windows Firewall. Make sure that Windows Firewall on the General tab is set to On. 2 Click the Advanced tab and Settings... button of the Network Connection Settings. 3 Click the Add button. 4 To add port 54925 for network scanning, enter the information below: <ol style="list-style-type: none"> 1. In Description of service: Enter any description, for example "Brother Scanner". 2. In Name or IP address (for example 192.168.0.12) of the computer hosting this service on your network: Enter "Localhost". 3. In External Port number for this service: Enter "54925" 4. In Internal Port number for this service: Enter "54925". 5. Make sure UDP is chosen. 6. Click OK. 5 Click the Add button. 6 To add port 54926 for network PC Fax, enter the information below: <ol style="list-style-type: none"> 1. In Description of service: Enter any description, for example "Brother PC Fax". 2. In Name or IP address (for example 192.168.0.12) of the computer hosting this service on your network: Enter "Localhost". 3. In External Port number for this service: Enter "54926". 4. In Internal Port number for this service: Enter "54926" 5. Make sure UDP is chosen. 6. Click OK. 7 If you still have trouble with your network connection, click the Add button. 8 To add port 137 for network scanning, network printing and network PC Fax receiving, enter the information below: <ol style="list-style-type: none"> 1. In Description of service: - Enter any description, for example "Brother PC Fax receiving" 2. In Name or IP address (for example 192.168.0.12) of the computer hosting this service on your network: Enter "Localhost". 3. In External Port number for this service: Enter "137". 4. In Internal Port number for this service: Enter "137". 5. Make sure UDP is chosen. 6. Click OK. 9 Make sure if the new setting is added and is checked, and then click OK.

Network difficulties (MFC-7440N and MFC-7840W only) (continued)

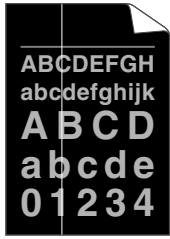
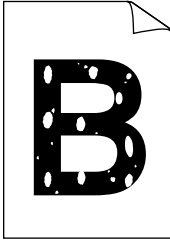

Difficulties	Suggestions
<p>The network scanning feature does not work.</p> <p>The network PC Fax Receive feature does not work.</p> <p>The network printing feature does not work.</p> <p>(continued)</p>	<p>For Windows Vista® users:</p> <ol style="list-style-type: none"> 1 Click the Start button, Control Panel, Network and Internet, Windows Firewall and click Change settings. 2 When the User Account Control screen appears, do the following. <ul style="list-style-type: none"> ■ Users who have administrator rights: Click Continue. ■ For users who do not have administrator rights: Enter the administrator password and click OK. 3 Make sure that Windows Firewall on the General tab is set to On. 4 Click the Exceptions tab. 5 Click the Add port... button. 6 To add port 54925 for network scanning, enter the information below: <ol style="list-style-type: none"> 1. In Name: Enter any description. (for example "Brother Scanner") 2. In Port number: Enter "54925". 3. Make sure UDP is chosen. Then click OK. 7 Click the Add port... button. 8 To add port 54926 for Network PC Fax, enter the information below: <ol style="list-style-type: none"> 1. In Name: Enter any description. (for example "Brother PC Fax") 2. In Port number: Enter "54926". 3. Make sure UDP is chosen. Then click OK. 9 Make sure that the new setting is added and is checked, and then click Apply. 10 If you still have trouble with your network connection such as network scanning or printing, check File and Printer Sharing box in the Exceptions tab and then click Apply.
<p>Your computer cannot find your machine.</p>	<p>For Windows® users: The firewall setting on your PC may be rejecting the necessary network connection. For details, see the instruction above.</p> <p>For Macintosh® users: Re-select your machine in the Device Selector application located in Macintosh HD/Library/Printers/Brother/Utilities/DeviceSelector or from the Model pop-up menu of ControlCenter2.</p>

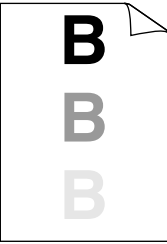
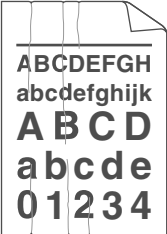
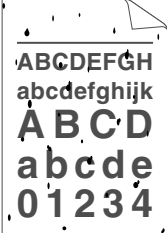

Improving the print quality

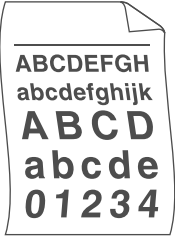
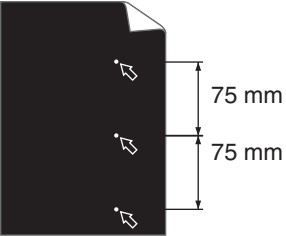
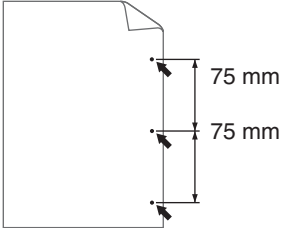
Examples of poor print quality	Recommendation
 <p>White lines across the page</p>	<ul style="list-style-type: none"> ■ Make sure that you use paper that meets our specifications. A rough surfaced paper or thick print media can cause the problem. (See <i>Acceptable paper and other print media</i> on page 14.) ■ Make sure that you choose the appropriate media type in the printer driver or in the machine's Paper Type menu setting. (See <i>Acceptable paper and other print media</i> on page 14 and <i>Basic tab in the Software User's Guide on the CD-ROM</i>.) ■ The problem may disappear by itself. Print multiple pages to clear this problem, especially if the machine has not been used for a long time. ■ The drum unit may be damaged. Put in a new drum unit. (See <i>Replacing the drum unit</i> on page 125.)
 <p>White lines down the page</p>	<ul style="list-style-type: none"> ■ Wipe the laser scanner windows with a soft cloth. (See <i>Cleaning the laser scanner window</i> on page 116.) ■ Make sure that a torn sheet of paper is not inside the machine covering the scanner window. ■ The toner cartridge may be damaged. Put in a new toner cartridge. (See <i>Replacing a toner cartridge</i> on page 122.) ■ The drum unit may be damaged. Put in a new drum unit. (See <i>Replacing the drum unit</i> on page 125.)
 <p>Hollow print</p>	<ul style="list-style-type: none"> ■ Make sure that you use paper that meets our specifications. (See <i>Acceptable paper and other print media</i> on page 14.) ■ Choose Thick paper mode in the printer driver, choose Thick in the machine's Paper Type menu setting or use thinner paper than you are currently using. (See <i>Paper type</i> on page 21 and <i>Basic tab in the Software User's Guide on the CD-ROM</i>.) ■ Check the machine's environment. Conditions such as high humidity can cause hollow print. (See <i>Choosing a location</i> on page 80.) ■ The drum unit may be damaged. Put in a new drum unit. (See <i>Replacing the drum unit</i> on page 125.)
 <p>Grey background</p>	<ul style="list-style-type: none"> ■ Make sure that you use paper that meets our specifications. (See <i>Acceptable paper and other print media</i> on page 14.) ■ Check the machine's environment. Conditions such as high temperatures and high humidity can increase the amount of background shading. (See <i>Choosing a location</i> on page 80.) ■ The toner cartridge may be damaged. Put in a new toner cartridge. (See <i>Replacing a toner cartridge</i> on page 122.) ■ The drum unit may be damaged. Put in a new drum unit. (See <i>Replacing the drum unit</i> on page 125.)

Examples of poor print quality	Recommendation
 <p data-bbox="234 552 385 581">Page skewed</p>	<ul style="list-style-type: none"> <li data-bbox="504 295 1241 382">■ Make sure that the paper or other print media is loaded correctly in the paper tray and that the guides are not too tight or too loose against the paper stack. <li data-bbox="504 392 1249 450">■ Set the paper guides correctly. (See <i>Loading paper in the paper tray</i> on page 9.) <li data-bbox="504 459 856 488">■ The paper tray may be too full. <li data-bbox="504 498 1195 566">■ If you are using the manual feed slot, see <i>Loading paper in the manual feed slot</i> on page 10. <li data-bbox="504 575 1249 633">■ Check the paper type and quality. (See <i>Acceptable paper and other print media</i> on page 14.)
 <p data-bbox="275 915 344 944">Ghost</p>	<ul style="list-style-type: none"> <li data-bbox="504 649 1249 736">■ Make sure that you use paper that meets our specifications. Rough-surfaced paper or thick paper may cause the problem. (See <i>Acceptable paper and other print media</i> on page 14.) <li data-bbox="504 745 1249 861">■ Make sure that you choose the correct media type in the printer driver or in the machine's Paper Type menu setting. (See <i>Acceptable paper and other print media</i> on page 14 and <i>Basic tab in the Software User's Guide on the CD-ROM</i>.) <li data-bbox="504 871 1188 938">■ The drum unit may be damaged. Put in a new drum unit. (See <i>Replacing the drum unit</i> on page 125.) <li data-bbox="504 948 1215 1006">■ The fuser unit may be contaminated. Call your Brother dealer for service.
 <p data-bbox="196 1278 422 1307">Wrinkles or creases</p>	<ul style="list-style-type: none"> <li data-bbox="504 1022 1249 1079">■ Check the paper type and quality. (See <i>Acceptable paper and other print media</i> on page 14.) <li data-bbox="504 1089 1249 1147">■ Make sure that paper is loaded correctly. (See <i>Loading paper in the paper tray</i> on page 9.) <li data-bbox="504 1157 1249 1215">■ Turn over the stack of paper in the tray or rotate the paper 180° in the input tray.
 <p data-bbox="248 1582 371 1611">Poor fixing</p>	<ul style="list-style-type: none"> <li data-bbox="504 1325 1249 1412">■ Choose Improve Toner Fixing mode in the printer driver. (See <i>Device Options (For Windows®)</i> or <i>Print Settings (For Macintosh®)</i> in the <i>Software User's Guide on the CD-ROM</i>.) <p data-bbox="532 1421 1208 1479">If you print only a few pages, change the printer driver setting in Media Type to a thin setting.</p>

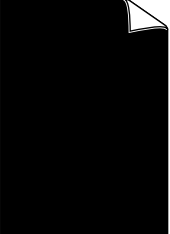
Examples of poor print quality	Recommendation
 <p data-bbox="193 552 367 581">Curled or wavy</p>	<ul style="list-style-type: none"> <li data-bbox="477 295 1163 349">■ Check the paper type and quality. High temperatures and high humidity will cause paper to curl. <li data-bbox="477 369 1222 479">■ If you do not use the machine often, the paper may have been in the paper tray too long. Turn over the stack of paper in the paper tray. Also, fan the paper stack and then rotate the paper 180° in the paper tray.
 <p data-bbox="134 855 426 938">White Spots on black text and graphics at 75 mm intervals</p>  <p data-bbox="155 1211 403 1263">Black Spots at 75 mm intervals</p>	<ul style="list-style-type: none"> <li data-bbox="477 595 1222 705">■ Make ten copies of a blank, white sheet of paper. (See <i>Making multiple copies</i> on page 68.) If the problem is not solved, the drum unit may have glue from a label stuck on the OPC drum surface. Clean the drum unit. (See <i>Cleaning the drum unit</i> on page 120.) <li data-bbox="477 724 1222 778">■ The drum unit may be damaged. Put in a new drum. (See <i>Replacing the drum unit</i> on page 125.)

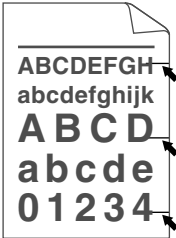
Examples of poor print quality	Recommendation
 <p data-bbox="279 556 343 581">Faint</p>	<ul style="list-style-type: none"> <li data-bbox="504 295 1255 382">■ Check the machine's environment. Conditions such as humidity, high temperatures, and so on, may cause this print fault. (See <i>Choosing a location</i> on page 80.) <li data-bbox="504 397 1255 537">■ If the whole page is too light, Toner Save mode may be on. Turn off Toner Save mode in the machine menu settings or Toner Save mode in the printer Properties of the driver. (See <i>Toner Save</i> on page 23 or <i>Advanced tab in the Software User's Guide on the CD-ROM</i>.) <li data-bbox="504 552 1255 639">■ Clean the scanner window and the corona wire of the drum unit. (See <i>Cleaning the laser scanner window</i> on page 116 and <i>Cleaning the corona wire</i> on page 118.) <li data-bbox="504 654 1255 716">■ The toner cartridge may be damaged. Put in a new toner cartridge. (See <i>Replacing a toner cartridge</i> on page 122.) <li data-bbox="504 732 1255 784">■ The drum unit may be damaged. Put in a new drum unit. (See <i>Replacing the drum unit</i> on page 125.)
 <p data-bbox="230 1058 392 1083">Toner specks</p>	<ul style="list-style-type: none"> <li data-bbox="504 797 1255 884">■ Make sure that you use paper that meets our specifications. Rough-surfaced paper may cause the problem. (See <i>Acceptable paper and other print media</i> on page 14.) <li data-bbox="504 900 1255 952">■ Clean the corona wire and the drum unit. (See <i>Cleaning the corona wire</i> on page 118 and <i>Cleaning the drum unit</i> on page 120.) <li data-bbox="504 967 1255 1029">■ The drum unit may be damaged. Put in a new drum unit. (See <i>Replacing the drum unit</i> on page 125.) <li data-bbox="504 1045 1255 1097">■ The fuser unit may be contaminated. Call your Brother dealer for service.
 <p data-bbox="257 1373 364 1398">All black</p>	<ul style="list-style-type: none"> <li data-bbox="504 1112 1255 1199">■ Clean the corona wire inside the drum unit by sliding the green tab. Be sure to return the green tab to the home position (▲). (See <i>Cleaning the corona wire</i> on page 118.) <li data-bbox="504 1215 1255 1277">■ The drum unit may be damaged. Put in a new drum unit. (See <i>Replacing the drum unit</i> on page 125.) <li data-bbox="504 1292 1255 1354">■ The fuser unit may be contaminated. Call your Brother dealer for service.

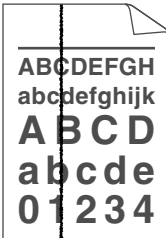
Examples of poor print quality	Recommendation
 <p data-bbox="112 556 445 614">Black toner marks across the page</p>	<ul style="list-style-type: none"> <li data-bbox="477 293 1218 351">■ Make sure that you use paper that meets our specifications. (See <i>Acceptable paper and other print media</i> on page 14.) <li data-bbox="477 363 1218 448">■ If you use label sheets for laser machines, the glue from the sheets may sometimes stick to the OPC drum surface. Clean the drum unit. (See <i>Cleaning the drum unit</i> on page 120.) <li data-bbox="477 459 1218 525">■ Do not use paper that has clips or staples because they will scratch the surface of the drum. <li data-bbox="477 537 1218 595">■ If the unpacked drum unit is in direct sunlight or room light, the unit may be damaged. <li data-bbox="477 606 1218 664">■ The toner cartridge may be damaged. Put in a new toner cartridge. (See <i>Replacing a toner cartridge</i> on page 122.) <li data-bbox="477 676 1218 734">■ The drum unit may be damaged. Put in a new drum unit. (See <i>Replacing the drum unit</i> on page 125.)
 <p data-bbox="159 1008 400 1039">Line across the page</p>	<ul style="list-style-type: none"> <li data-bbox="477 749 1218 834">■ Clean the laser scanner window and the corona wire inside the drum unit. (See <i>Cleaning the laser scanner window</i> on page 116 and <i>Cleaning the corona wire</i> on page 118.) <li data-bbox="477 846 1218 904">■ The drum unit may be damaged. Put in a new drum unit. (See <i>Replacing the drum unit</i> on page 125.)
 <p data-bbox="128 1313 430 1414">Black lines down the page Printed pages have toner stains down the page</p>	<ul style="list-style-type: none"> <li data-bbox="477 1047 1218 1132">■ Clean the corona wire inside the drum unit by sliding the green tab. Be sure to return the green tab to the home position (▲). (See <i>Cleaning the corona wire</i> on page 118.) <li data-bbox="477 1143 1218 1201">■ The toner cartridge may be damaged. Put in a new toner cartridge. (See <i>Replacing a toner cartridge</i> on page 122.) <li data-bbox="477 1213 1218 1271">■ The drum unit may be damaged. Put in a new drum unit. (See <i>Replacing the drum unit</i> on page 125.) <li data-bbox="477 1282 1218 1321">■ The fuser unit may be smudged. Call your Brother dealer for service.

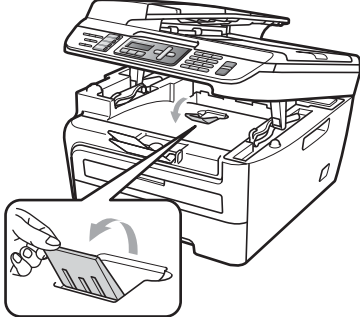
Examples of poor print quality	Recommendation
 <p data-bbox="271 566 348 591">Curled</p>	<ul style="list-style-type: none"> <li data-bbox="504 295 1255 411">■ Choose Reduce Paper Curl mode in the printer driver when you do not use our recommended paper. (See <i>Device Options (For Windows®)</i> or <i>Print Settings (For Macintosh®)</i> in the <i>Software User's Guide on the CD-ROM.</i>) <li data-bbox="504 430 1222 488">■ Turn the paper over in the paper tray, and print again. (Excluding Letterhead paper) <li data-bbox="504 508 895 527">■ Lift up the output tray support flap.  <ul style="list-style-type: none"> <li data-bbox="504 904 1255 962">■ Replace the paper in the paper tray with paper from a freshly opened ream. <li data-bbox="504 981 1255 1029">■ Make sure you are using paper that is recommended for your machine. (See <i>Acceptable paper and other print media</i> on page 14.)

Setting dial tone detection

When you send a fax automatically, by default your machine will wait for a fixed amount of time before it starts to dial the number. By changing the Dial Tone setting to *Detection* you can make your machine dial as soon as it detects a dial tone. This setting can save a small amount of time when sending a fax to many different numbers. If you change the setting and start having problems with dialling you should change back to the default *No Detection* setting.

- 1 Press **Menu**, **0**, **5**.
- 2 Press **▲** or **▼** to choose *Detection* or *No Detection*. Press **OK**.
- 3 Press **Stop/Exit**.

Telephone line interference

If you are having difficulty sending or receiving a fax due to possible interference on the telephone line, we recommend that you adjust the Equalization for compatibility to reduce the modem speed for fax operations.

- 1 Press **Menu**, **2**, **0**, **1**.
- 2 Press **▲** or **▼** to choose **Basic (for VoIP)** or **Normal** or **High (MFC-7840W)**.

- **Basic (for VoIP)** cuts the modem speed to 9600 bps. and turns the error correction mode (ECM) off.

For a standard telephone line: If you regularly experience interference on your standard telephone line try this setting.

If you are using VoIP: VoIP service providers offer fax support using various standards. If you regularly experience fax transmission errors try this setting.

- **Normal** sets the modem speed at 14400 bps.
- **High** sets the modem speed at 33600 bps. (MFC-7840W only)

Press **OK**.

- 3 Press **Stop/Exit**.



Note

When you change the compatibility to **Basic (for VoIP)**, the ECM feature is not available.

Error and maintenance messages

As with any sophisticated office product, errors may occur and consumable items may need to be replaced. If this happens, your machine identifies the error or required routine maintenance and shows the appropriate message. The most common error and maintenance messages are shown below.

You can clear most errors and routine maintenance messages by yourself. If you need more help, the Brother Solutions Center offers the latest FAQs and troubleshooting tips.

Visit us at <http://solutions.brother.com/>.

Error Message	Cause	Action
BT Call Sign On (U.K. only)	BT Call Sign is set to On. You cannot change the Receive Mode from Manual to another mode.	Set BT Call Sign to Off. (See <i>BT call sign (U.K. only)</i> on page 46.)
Cartridge Error	The toner cartridge is not installed correctly.	Pull out the drum unit, take out the toner cartridge that is indicated on the LCD, and put it back into the drum unit again.
Drum End Soon	The drum unit is near the end of its life.	Use the drum unit until you have a print quality problem; then replace the drum unit with a new one. (See <i>Replacing the drum unit</i> on page 125.)
Size mismatch	The paper in the tray is not the correct size.	Load the correct size of paper in the tray and set the "Paper Size" (Menu, 1, 3 (See <i>Paper size</i> in Chapter 3)).
Comm. Error	Poor telephone line quality caused a communication error.	Try sending the fax again or try connecting the machine to another telephone line. If the problem continues, call the telephone company and ask them to check your telephone line.
Connection Fail	You tried to poll a fax machine that is not in Polled Waiting mode.	Check the other fax machine's polling setup.

Error Message	Cause	Action
Cooling Down Wait for a while	The temperature of the drum unit or toner cartridge is too hot. The machine will pause its current print job and go into cooling down mode. During the cooling down mode, you will hear the cooling fan running while the LCD shows <i>Cooling Down</i> , and <i>Wait for a while</i> .	<p>Make sure that you can hear the fan in the machine spinning and that the exhaust outlet is not blocked by something.</p> <p>If the fan is spinning, remove any obstacles that surround the exhaust outlet, and then leave the machine turned on but do not use it for several minutes.</p> <p>If the fan is not spinning do one of the following:</p> <p>(MFC-7320 and MFC-7440N only) See <i>Transferring your faxes or Fax Journal report</i> on page 107 before disconnecting the machine so you will not lose any important messages. Then, disconnect the machine from the power for several minutes and then reconnect it.</p> <p>(MFC-7840W only) Disconnect the machine from the power for several minutes, then reconnect it. (The machine can be turned off for up to 4 days without losing faxes stored in the memory. See <i>Transferring your faxes or Fax Journal report</i> on page 107.</p>
Cover is Open Close the Front Cover.	The front cover is not closed completely.	Close the front cover of the machine.
Cover is Open Close the Fuser Cover.	The fuser cover is not closed completely.	Close the fuser cover of the machine.
Cover is Open Open the Back Cover and remove the jammed paper, or close the Fuser Cover.	The fuser cover is not closed completely or paper was jammed in the back of the machine when you turned on the power.	Make sure paper is not jammed inside the back of the machine, and then close the fuser cover and press Start .
Disconnected	The other person or other person's fax machine stopped the call.	Try to send or receive again.
Document Jam	The document was not inserted or fed correctly, or the document scanned from the ADF was too long.	See <i>Document jams</i> on page 109 or <i>Using the automatic document feeder (ADF)</i> on page 19.
Drum Error	The corona wire on the drum unit needs to be cleaned.	Clean the corona wire on the drum unit. (See <i>Cleaning the corona wire</i> on page 118.)
	The drum unit has reached the end of its life.	Replace the drum unit. (See <i>Replacing the drum unit</i> on page 125.)

Error Message	Cause	Action
Fuser Error	<p>The temperature of fuser unit does not rise at a specified temperature within specified time.</p> <p>The fuser unit is too hot.</p>	<p>Do one of the following:</p> <ul style="list-style-type: none"> ■ (MFC-7320 and MFC-7440N only) Received fax messages still in memory will be lost when the machine is turned off. See <i>Transferring your faxes or Fax Journal report</i> on page 107 before disconnecting the machine so you will not lose any important messages. Then, turn the power switch off, wait a few seconds, and then turn it on again. Leave the machine for 15 minutes with the power on. ■ (MFC-7840W only) Turn the power switch off, wait a few seconds, and then turn it on again. Leave the machine for 15 minutes with the power on. The machine can be turned off for up to 4 days without losing faxes stored in the memory. (See <i>Transferring your faxes or Fax Journal report</i> on page 107.)
Init Unable XX	The machine has a mechanical problem.	<p>Do one of the following:</p> <ul style="list-style-type: none"> ■ (MFC-7320 and MFC-7440N only) See <i>Transferring your faxes or Fax Journal report</i> on page 107 before disconnecting the machine so you will not lose any important messages. Then, disconnect the machine from the power for several minutes and then reconnect it. ■ (MFC-7840W only) Disconnect the machine from the power for several minutes, then reconnect it. (The machine can be turned off for up to 4 days without losing faxes stored in the memory. See <i>Transferring your faxes or Fax Journal report</i> on page 107.)
Jam Rear	The paper is jammed in the back of the machine.	(See <i>Paper jams</i> on page 110.)
Jam Inside	The paper is jammed inside the machine.	(See <i>Paper jams</i> on page 110.)
Jam Tray	The paper is jammed in the paper tray of the machine.	(See <i>Paper jams</i> on page 110.)
No Paper	The machine is out of paper or paper is not correctly loaded in the paper tray.	<p>Do one of the following:</p> <ul style="list-style-type: none"> ■ Refill the paper in the paper tray, and then press Start. ■ Remove the paper and load it again, and then press Start.



Error Message	Cause	Action
No Response/Busy	The number you dialed does not answer or is busy.	Verify the number and try again.
Not Registered	You tried to access a One Touch or Speed Dial number that is not programmed.	Set up the One Touch or Speed Dial number. (See <i>Storing one touch dial numbers</i> on page 52 and <i>Storing speed dial numbers</i> on page 53.)
Out of Memory	The machine's memory is full.	<p>Fax sending or copy operation in progress</p> <p>Do one of the following:</p> <ul style="list-style-type: none"> ■ Press Start to send or copy the scanned pages. ■ Press Stop/Exit and wait until the other operations in progress finish, and then try again. ■ Clear the data from the memory. (See <i>Out of memory message</i> on page 38 or page 73.) <p>Print operation in process</p> <p>Do one of the following:</p> <ul style="list-style-type: none"> ■ Reduce print resolution. (See <i>Advanced tab in the Software User's Guide on the CD-ROM.</i>) ■ Clear the faxes from the memory. (See <i>Out of memory message</i> on page 73.)
Print Unable XX	The machine has a mechanical problem.	<p>Do one of the following:</p> <ul style="list-style-type: none"> ■ (MFC-7320 and MFC-7440N only) See <i>Transferring your faxes or Fax Journal report</i> on page 107 before disconnecting the machine so you will not lose any important messages. Then, disconnect the machine from the power for several minutes and then reconnect it. ■ (MFC-7840W only) Disconnect the machine from the power for several minutes, then reconnect it. (The machine can be turned off for up to 4 days without losing faxes stored in the memory. See <i>Transferring your faxes or Fax Journal report</i> on page 107.)

Error Message	Cause	Action
Scan Unable XX	The machine has a mechanical problem.	Do one of the following: <ul style="list-style-type: none"> ■ (MFC-7320 and MFC-7440N only) See <i>Transferring your faxes or Fax Journal report</i> on page 107 before disconnecting the machine so you will not lose any important messages. Then, disconnect the machine from the power for several minutes and then reconnect it. ■ (MFC-7840W only) Disconnect the machine from the power for several minutes, then reconnect it. (The machine can be turned off for up to 4 days without losing faxes stored in the memory. See <i>Transferring your faxes or Fax Journal report</i> on page 107.)
Toner Life End	The drum unit and toner cartridge assembly is not installed correctly, or the toner cartridge is used up and printing is not possible.	Do one of the following: <ul style="list-style-type: none"> ■ Re-install the toner cartridge and drum unit assembly. ■ Replace the empty toner cartridge with a new one. (See <i>Replacing a toner cartridge</i> on page 122.)
Toner Low	If the LCD shows <i>Toner Low</i> , you can still print; however, the machine is telling you that the toner cartridge is near the end of its life and the toner will soon need replacing.	Order a new toner cartridge now.

Transferring your faxes or Fax Journal report

If the LCD shows:

- Init Unable XX
- Print Unable XX
- Scan Unable XX

We recommend transferring your faxes to another fax machine or to your PC. (See *Transferring faxes to another fax machine* on page 107 or *Transferring faxes to your PC* on page 108.)

You can also transfer the Fax Journal report to see if there are any faxes you need to transfer. (See *Transferring Fax Journal report to another fax machine* on page 108.)



Note

If there is an error message on the machine's LCD, after the faxes have been transferred, disconnect the machine from the power source for several minutes, and then reconnect it.

Transferring faxes to another fax machine

If you have not set up your Station ID, you cannot enter fax transfer mode. (See *Setting your station ID in the Quick Setup Guide*.)

- 1 Press **Menu**, **9**, **0**, **1**.

- 2 Do one of the following:
 - If the LCD shows `No Data`, there are no faxes left in the machine's memory.
Press **Stop/Exit**.
 - Enter the fax number to which faxes will be forwarded.
- 3 Press **Start**.

Transferring faxes to your PC

You can transfer the faxes from your machine's memory to your PC.

- 1 Make sure that you have installed **MFL-Pro Suite** on your PC, and then turn on **PC-Fax Receiving** on the PC. (For details about PC Fax Receive, see *PC-FAX receiving in the Software User's Guide on the CD-ROM*.)
- 2 Make sure that you have set `PC Fax Receive` on the machine. (See *PC fax receive* on page 57.)
If faxes are in the machine's memory when you set up PC Fax Receive, the LCD will ask if you want to transfer the faxes to your PC.
- 3 Do one of the following:
 - To transfer all faxes to your PC, press **1**. You will be asked if you want a backup print.
 - To exit and leave the faxes in the memory, press **2**.
- 4 Press **Stop/Exit**.

Transferring Fax Journal report to another fax machine

If you have not set up your Station ID, you cannot enter fax transfer mode. (See *Setting your station ID in the Quick Setup Guide*.)

- 1 Press **Menu, 9, 0, 2**.
- 2 Enter the fax number to which the Fax Journal report will be forwarded.
- 3 Press **Start**.

Document jams

If the document is jammed, follow the steps below.



Note

After removing a jammed document, check that no paper scraps are left in the machine that could cause another jam.

Document is jammed in the top of the ADF unit

- 1 Take out any paper from the ADF that is not jammed.
- 2 Open the ADF cover.
- 3 Pull the jammed document out to the left.

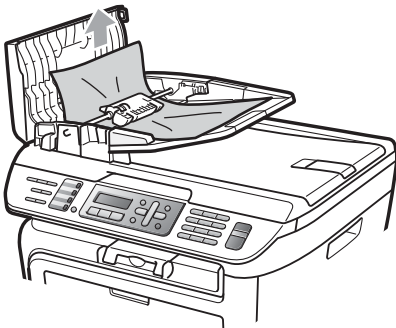

- 4 Close the ADF cover.
- 5 Press **Stop/Exit**.

Document is jammed under the document cover

- 1 Take out any paper from the ADF that is not jammed.
- 2 Lift the document cover.
- 3 Pull the jammed document out to the right.

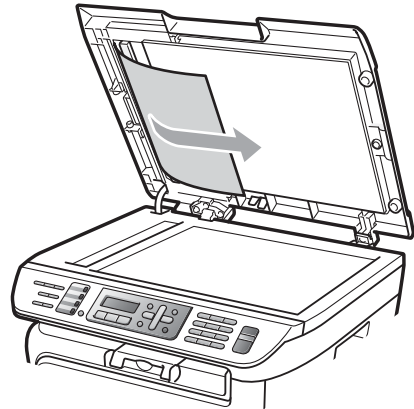

- 4 Close the document cover.
- 5 Press **Stop/Exit**.

Document is jammed at the output tray

- 1 Pull the jammed document out to the right.

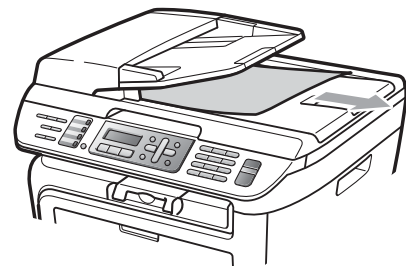

- 2 Press **Stop/Exit**.

Paper jams

To clear paper jams, please follow the steps in this section.

Note

- Please confirm that you have installed both a toner cartridge and a drum unit in the machine. If you have not installed a drum unit or have installed the drum unit incorrectly, then this may cause a paper jam in your Brother machine.
- If the error message remains, open and close the front cover and fuser cover firmly to reset the machine.

WARNING

HOT SURFACE

After you have just used the machine, some internal parts of the machine will be extremely hot. To prevent injury, when you open the front or back cover (back output tray) of the machine, DO NOT touch the shaded parts shown in the illustration.

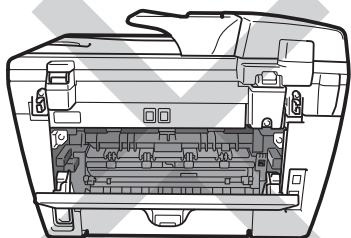
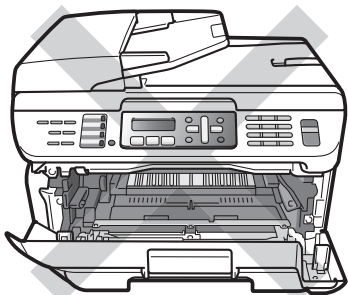

CAUTION

To prevent damage to the machine caused by static electricity, DO NOT touch the electrodes shown in the illustration.

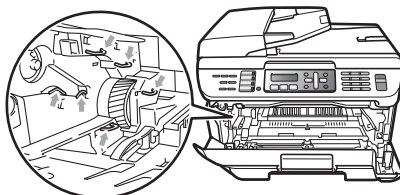

Paper is jammed inside the machine

- 1 Open the front cover.



- 2 Slowly take out the drum unit and toner cartridge assembly. The jammed paper will be pulled out with the toner cartridge and drum unit assembly.

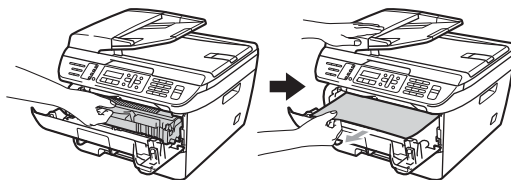

! CAUTION

We recommend that you place the drum unit and toner cartridge assembly on a clean, flat surface with a sheet of disposable paper or cloth underneath it in case you accidentally spill or scatter toner.

- 3 If you cannot remove the drum unit and toner cartridge assembly easily, do not use extra force. Instead, lift the scanner cover.

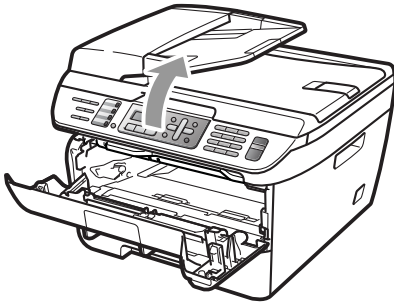

Use both hands to carefully pull the jammed paper up and out of the output tray opening.

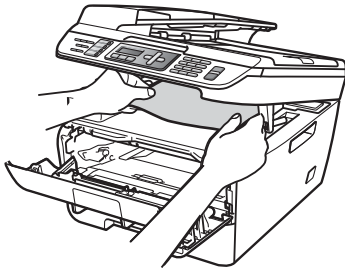

- 4 Close the scanner cover.

- 5 If you cannot pull the jammed paper out of the output tray opening, take the paper tray completely out of the machine.

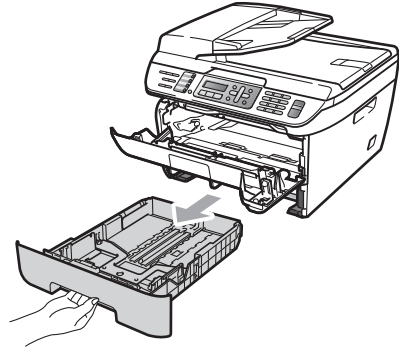

- 6 Pull the jammed paper out of the paper tray opening.

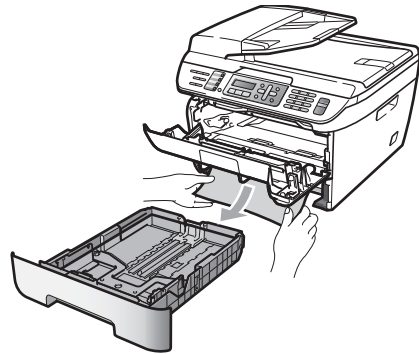

- 7 Put the drum unit and toner cartridge assembly back in the machine.

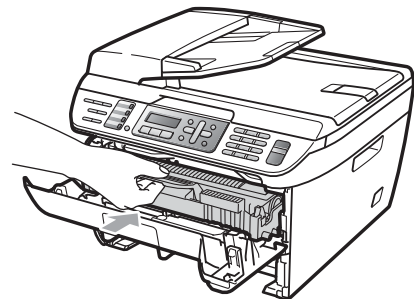

- 8 Put the paper tray back in the machine.
9 Close the front cover.

Paper is jammed at the back of the machine

- 1 Open the front cover.

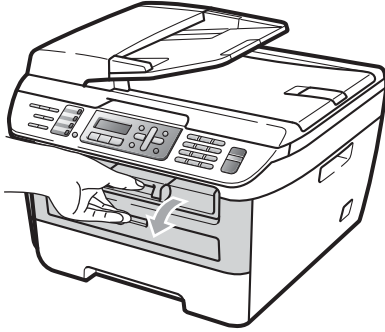

- 2 Slowly take out the drum unit and toner cartridge assembly.

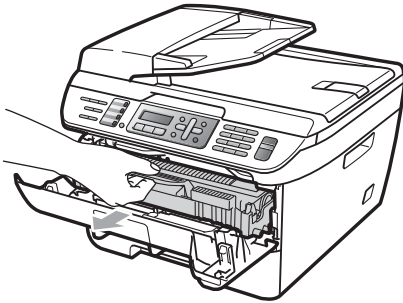

! CAUTION

We recommend that you place the drum unit and toner cartridge assembly on a clean, flat surface with a sheet of disposable paper or cloth underneath it in case you accidentally spill or scatter toner.

- 3 Open the back cover (back output tray).

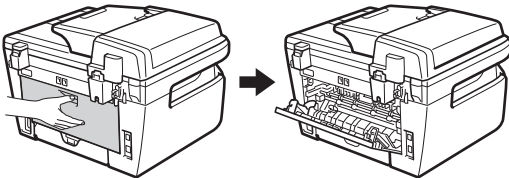

- 4 Pull the tabs toward you to open the fuser cover (1).

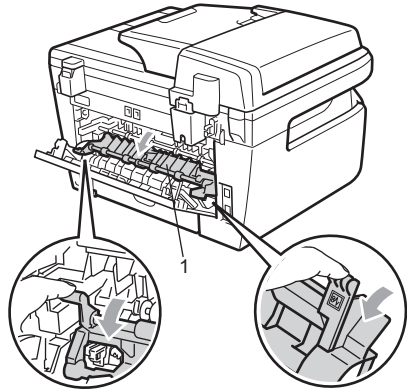

- 5 Pull the jammed paper out of the fuser unit.

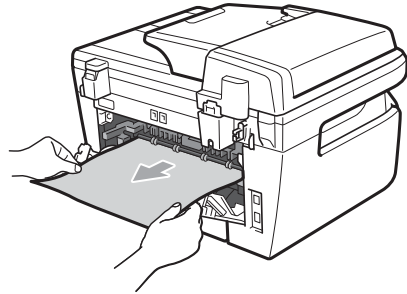

- 6 Close the back cover (back output tray).

- 7 Put the drum unit and toner cartridge assembly back in the machine.

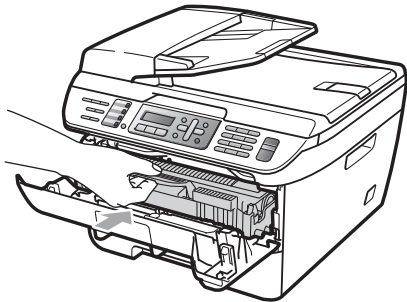

- 8 Close the front cover.

Paper is jammed inside the drum unit and toner cartridge assembly

- 1 Open the front cover.

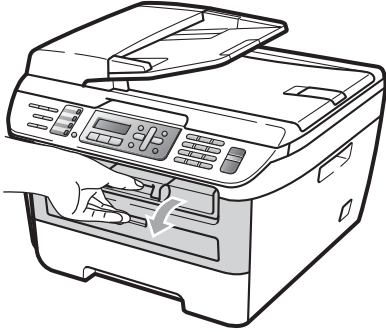

- 2 Slowly take out the drum unit and toner cartridge assembly.

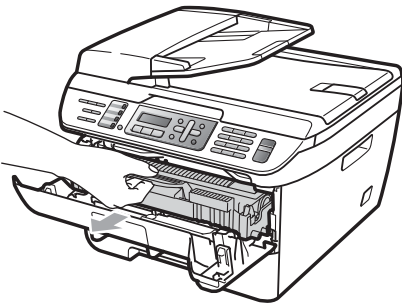

! CAUTION

We recommend that you place the drum unit and toner cartridge assembly on a clean, flat surface with a sheet of disposable paper or cloth underneath it in case you accidentally spill or scatter toner.

- 3 Push down the green lock lever and take the toner cartridge out of the drum unit.

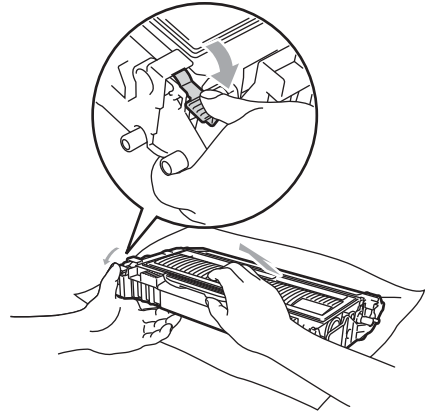

! CAUTION

Handle the toner cartridge carefully. If toner scatters on your hands or clothes, wipe or wash it off with cold water at once.

To avoid print quality problems, DO NOT touch the shaded parts shown in the illustrations below.

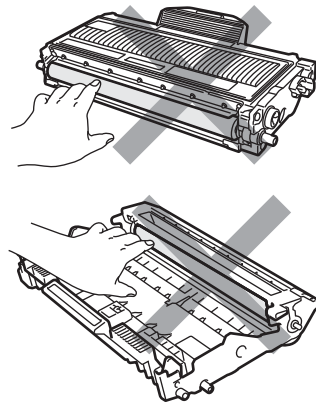

- 4 Clear the jammed paper if there is any inside the drum unit.

- 5 Put the toner cartridge back into the drum unit until you hear it lock into place. If you put it in correctly, the green lock lever will lift automatically.

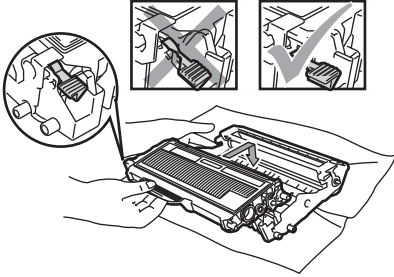

- 6 Put the drum unit and toner cartridge assembly back in the machine.

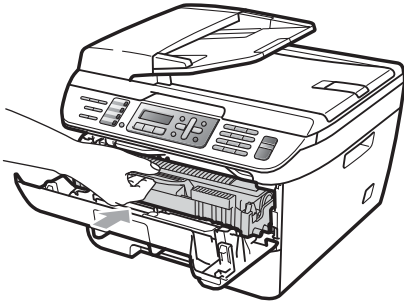

- 7 Close the front cover.

Routine maintenance

WARNING

Use neutral detergents.

DO NOT use any flammable substances, spray or organic solvent/liquids containing alcohol/ammonia to clean the inside or outside of the machine. Doing this may cause a fire or electrical shock. For more information see *Important safety instructions* on page 86.

CAUTION

The drum unit contains toner, so handle it carefully. If toner scatters on your hands or clothes, wipe or wash it off with cold water at once.

Cleaning the outside of the machine

- 1 Turn off the machine. Unplug the telephone line cord first, disconnect all cables, and then unplug the power cord from the electrical socket.
- 2 Pull the paper tray completely out of the machine.

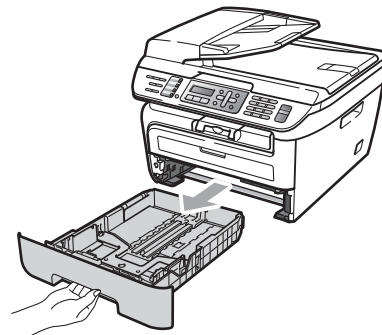

- Wipe the outside of the machine with a soft cloth to remove dust.

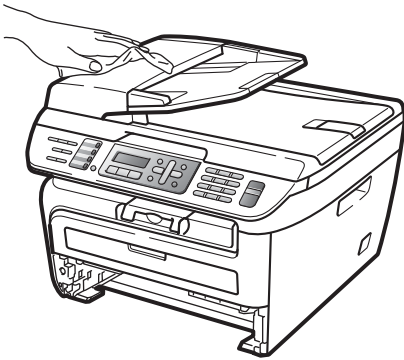

- Remove any paper that is in the paper tray.

- Wipe the inside and the outside of the paper tray with a soft cloth to remove dust.

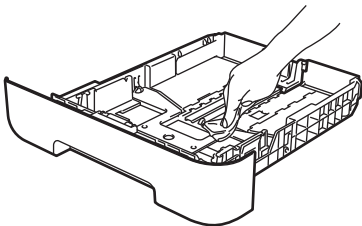

- Re-load the paper and put the paper tray firmly back in the machine.

- Plug the machine's power cord back into the electrical socket first, and reconnect all cables and telephone line cord. Turn on the machine.

Cleaning the scanner glass

- Turn off the machine. Unplug the telephone line cord first, disconnect all cables and then unplug the power cord from the electrical socket.
- Lift the document cover (1). Clean the white plastic surface (2) and scanner glass (3) underneath it with a soft lint-free cloth moistened with water.

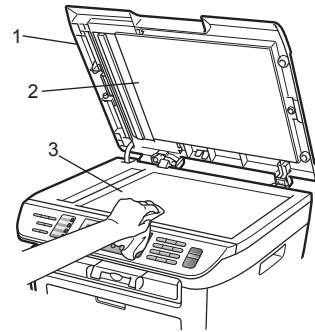

- In the ADF unit, clean the white bar (1) and the scanner glass strip (2) underneath it with a soft lint-free cloth moistened with water.

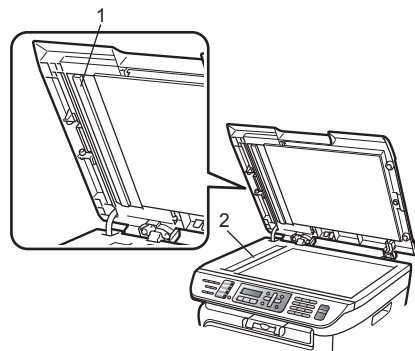

- 4 Plug the machine's power cord back into the electrical socket first, and reconnect all cables and telephone line cord. Turn on the machine.

 **Note**

In addition to cleaning the scanner glass and glass strip with a soft lint-free cloth moistened with water, run your finger tip over the glass to see if you can feel anything on it. If you feel dirt or debris, clean the glass again concentrating on that area. You may need to repeat the cleaning process three or four times. To test, make a copy after each cleaning.

Cleaning the laser scanner window

 **WARNING**

Use neutral detergents.

DO NOT use any flammable substances, spray or organic solvent/liquids containing alcohol/ammonia to clean the inside or outside of the machine. Doing this may cause a fire or electrical shock. For more information see *Important safety instructions* on page 86.

 **CAUTION**

DO NOT touch the laser scanner window with your fingers.

- 1 Before you clean the inside of the machine, turn off the machine. Unplug the telephone line cord first, and then unplug the power cord from the electrical socket.
- 2 Open the front cover and slowly take out the drum unit and toner cartridge assembly.



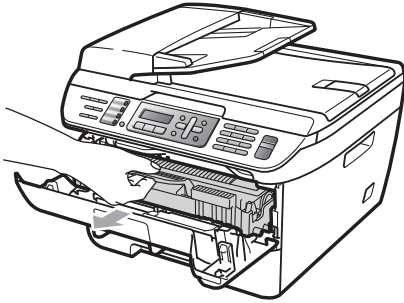

! WARNING

! HOT SURFACE

After you have just used the machine, some internal parts of the machine will be extremely hot. To prevent injury, when you open the front or back cover (back output tray) of the machine, DO NOT touch the shaded parts shown in the illustration.

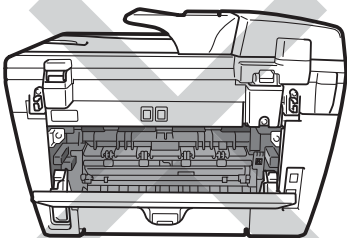
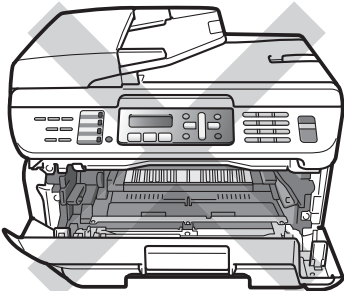

! CAUTION

To prevent damage to the machine caused by static electricity, DO NOT touch the electrodes shown in the illustration.

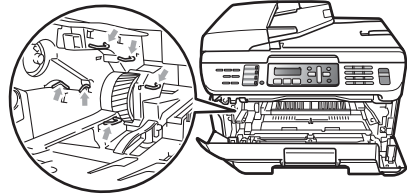

We recommend that you place the drum unit on a clean, flat surface with a sheet of disposable paper or cloth underneath it in case you accidentally spill or scatter toner.

- 3 Wipe the laser scanner window by wiping it with a clean soft, dry lint-free cloth.

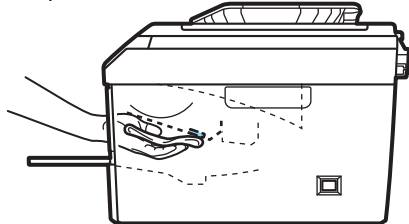
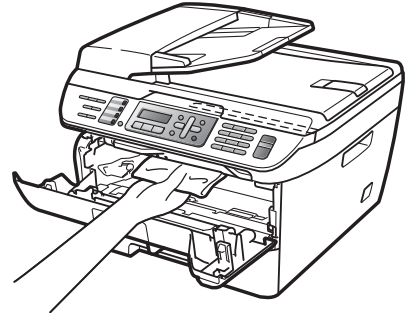

- Put the drum unit and toner cartridge assembly back in the machine.

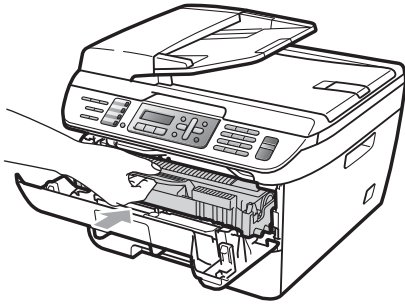

- Close the front cover.
- Plug the machine's power cord back into the electrical socket first, and then plug in the telephone line cord. Turn on the machine.

- Slowly take out the drum unit and toner cartridge assembly.

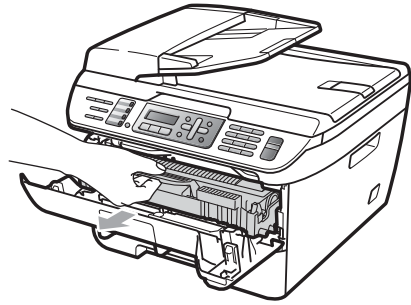

! CAUTION

We recommend that you place the drum unit and toner cartridge assembly on a clean, flat surface with a sheet of disposable paper or cloth underneath it in case you accidentally spill or scatter toner.

Handle the toner cartridge carefully. If toner scatters on your hands or clothes, wipe or wash it off with cold water at once.

To prevent damage to the machine caused by static electricity, DO NOT touch the electrodes shown in the illustration.

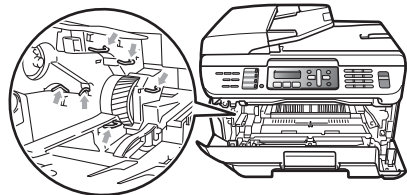

Cleaning the corona wire

If you have print quality problems, clean the corona wire as follows:

- Turn off the machine. Unplug the telephone line cord first, disconnect all cables, and then unplug the power cord from the electrical socket.
- Open the front cover.

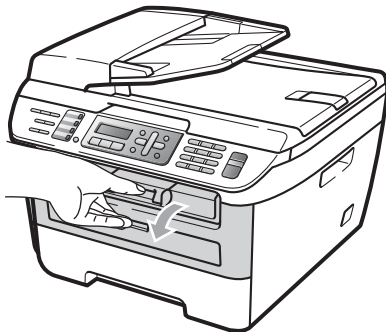

- 4 Clean the corona wire inside the drum unit by gently sliding the green tab from right to left and left to right several times.

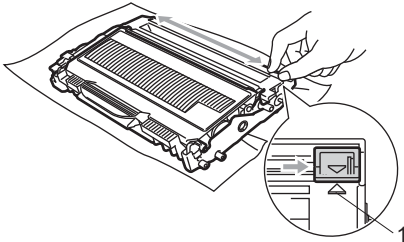

! CAUTION

Be sure to return the green tab to the home position (▲) (1). If you do not, printed pages may have a vertical stripe.

- 5 Put the drum unit and toner cartridge assembly back in the machine.

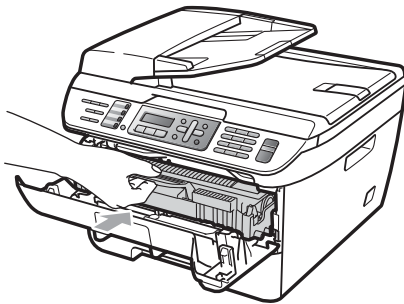

- 6 Close the front cover.
- 7 Plug the machine's power cord back into the electrical socket first, and then reconnect all cables and telephone line cord. Turn on the machine.

! CAUTION

To avoid print quality problems, DO NOT touch the shaded parts shown in the illustrations below.

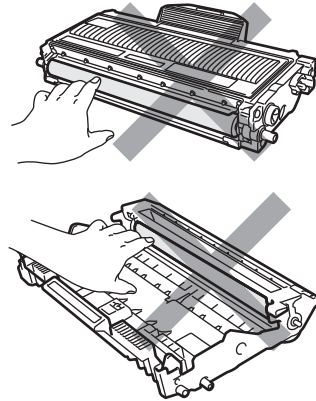

Cleaning the drum unit

If you have print quality problems, clean the drum unit as follows.

- 1 Turn off the machine. Unplug the telephone line cord first, and then unplug the power cord from the electrical socket.
- 2 Open the front cover.

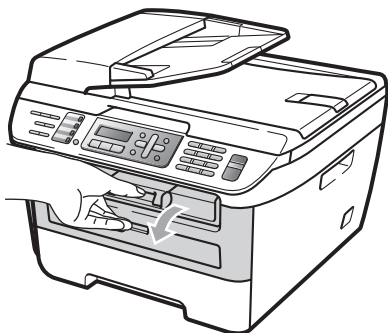

- 3 Slowly take out the drum unit and toner cartridge assembly.

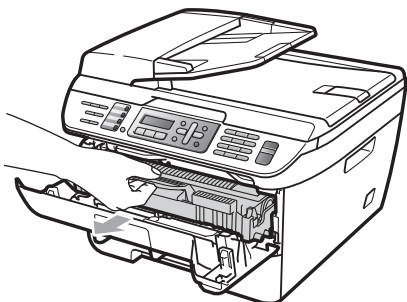

! CAUTION

We recommend that you put the drum unit and toner cartridge assembly on a clean, flat surface with a sheet of disposable paper or cloth underneath it in case you accidentally spill or scatter toner.

To prevent damage to the machine caused by static electricity, DO NOT touch the electrodes shown in the illustration.

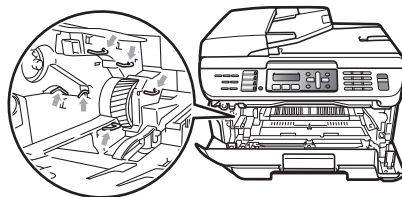

- 4 Push down the green lock lever and take the toner cartridge out of the drum unit.

! CAUTION

Handle the toner cartridge carefully. If toner scatters on your hands or clothes, wipe or wash it off with cold water at once.

To avoid print quality problems, DO NOT touch the shaded parts shown in the illustrations below.

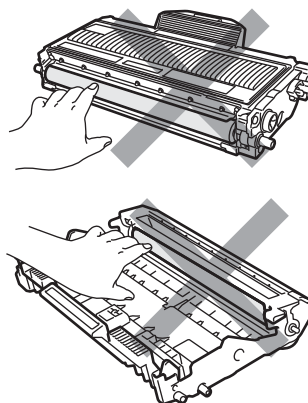

- 5 Put the print sample in front of the drum unit, and find the exact position of the poor print.

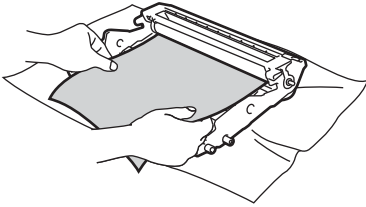

- 6 Turn the drum unit gear by hand while looking at the surface of the OPC drum (1).

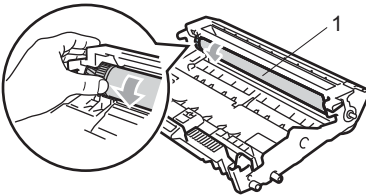

- 7 When you have found the mark on the drum that matches the print sample, wipe the surface of the OPC drum with a dry cotton swab until the dust or glue on the surface comes off.

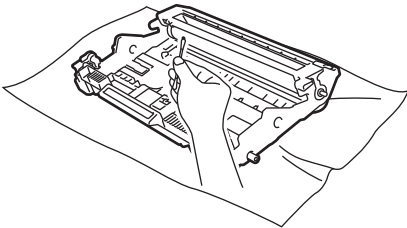

- 8 Put the toner cartridge back into the drum unit until you hear it lock into place. If you put the cartridge in correctly, the green lock lever will lift automatically.

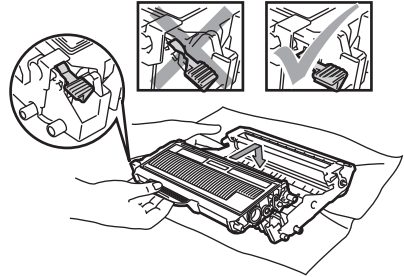

- 9 Put the drum unit and toner cartridge assembly back in the machine.

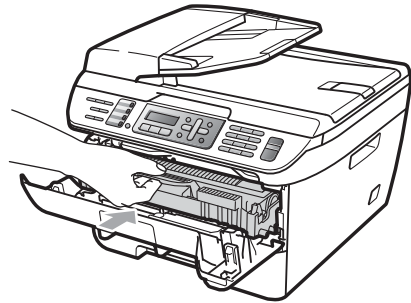

- 10 Close the front cover.

- 11 Plug the machine's power cord back into the electrical socket first, and then reconnect all cables and telephone line cord. Turn on the machine.

! CAUTION

The drum is photosensitive so **DO NOT** touch it with your fingers.

DO NOT clean the surface of the photosensitive drum with a sharp object.

DO NOT use excessive force when cleaning the drum unit.

Replacing the consumable items

You will need to replace the consumable items when the machine indicates that the life of the consumable is over.

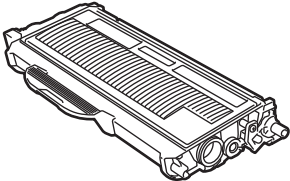
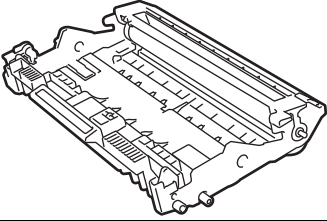
Toner cartridge	Drum unit
	
Order No. TN-2110, TN-2120	Order No. DR-2100

Note

- Discard used consumable items according to local regulations. (See *EU Directive 2002/96/EC and EN50419* on page 85.) If you have questions, call your local waste disposal office. Be sure to reseal the consumable items tightly so that the material inside does not spill.
- We recommend placing used consumable items on a sheet of paper to prevent accidentally spilling or scattering the material inside.
- If you use paper that is not a direct equivalent for the recommended paper, the life of consumable items and machine parts may be reduced.

Replacing a toner cartridge

The High Yield toner cartridges can print approximately 2,600 pages¹ and the Standard toner cartridges can print approximately 1,500 pages¹. Actual page count will vary depending on your average type of document (i.e., standard letter, detailed graphics).

When a toner cartridge is running low, the LCD shows `Toner Low`.

¹ Approx. cartridge yield is declared in accordance with ISO/IEC 19752.

Note

It is a good idea to keep a new toner cartridge ready for use when you see the `Toner Low` warning.

! WARNING

! HOT SURFACE

After you have just used the machine, some internal parts of the machine will be extremely hot. To prevent injury, when you open the front or back cover (back output tray) of the machine, **DO NOT** touch the shaded parts shown in the illustration.

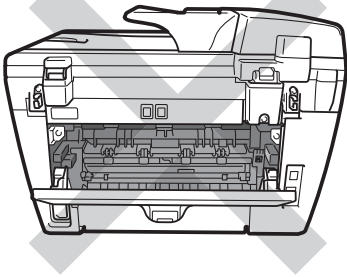
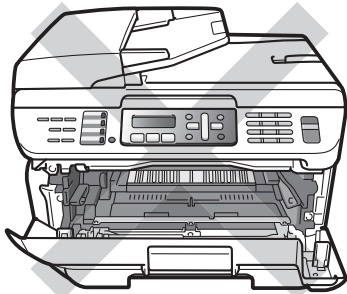

- 1 Open the front cover.

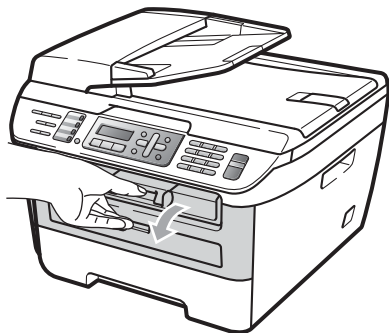

- 2 Slowly take out the drum unit and toner cartridge assembly.

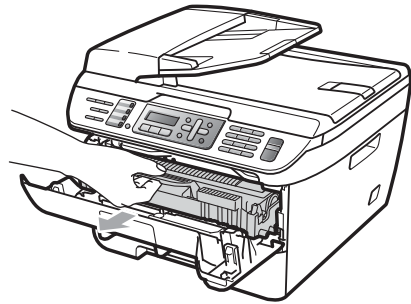

! CAUTION

We recommend that you put the drum unit and toner cartridge assembly on a clean, flat surface with a sheet of disposable paper or cloth underneath it in case you accidentally spill or scatter toner.

To prevent damage to the machine caused by static electricity, **DO NOT** touch the electrodes shown in the illustration.

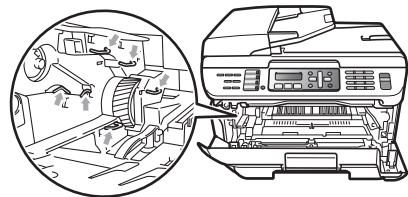

- 3 Push down the green lock lever and take the used toner cartridge out of the drum unit.

! WARNING

DO NOT put a toner cartridge into a fire. It could explode, resulting in injuries.

! CAUTION

Handle the toner cartridge carefully. If toner scatters on your hands or clothes, wipe or wash it off with cold water at once.

To avoid print quality problems, DO NOT touch the shaded parts shown in the illustrations.

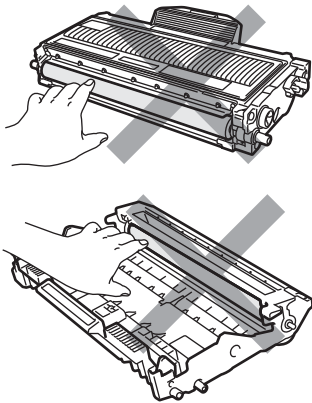

Brother machines are designed to work with toner of a particular specification and will work to a level of optimum performance when used with genuine Brother toner cartridges (TN-2110/TN-2120). Brother cannot guarantee this optimum performance if toner or toner cartridges of other specifications are used. Brother does not therefore recommend the use of cartridges other than genuine Brother cartridges with this machine, or the refilling of empty cartridges with toner from other sources. If damage is caused to the drum unit or other parts of this machine as a result of the use of toner or toner cartridges other than genuine Brother products due to the incompatibility or lack of suitability of those products with this machine, any repairs required as a result may not be covered by the warranty.

Unpack the toner cartridge just before you put it in the machine. If a toner cartridge is left unpacked for a long time, the toner life will be shortened.

📄 Note

Be sure to seal up the used toner cartridge tightly in a suitable bag so that toner powder does not spill out of the cartridge.

- 4 Unpack the new toner cartridge. Hold the cartridge level with both hands and gently rock it from side to side five or six times to spread the toner evenly inside the cartridge.

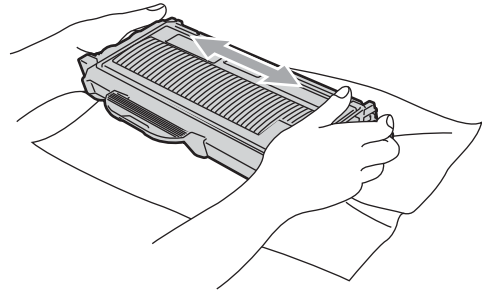

- 5 Pull off the protective cover.

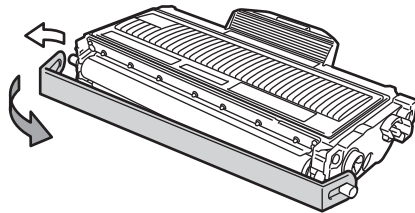

- 6 Put the new toner cartridge firmly into the drum unit until you hear it lock into place. If you put it in correctly, the lock lever will lift automatically.

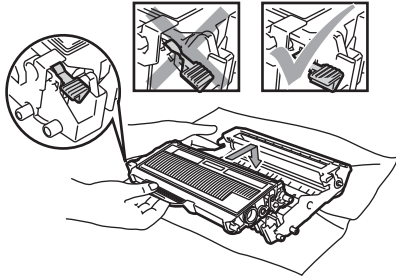

! CAUTION

Make sure that you put in the toner cartridge correctly or it may separate from the drum unit.

- 7 Clean the corona wire of the drum unit by gently sliding the green tab from right to left and left to right several times.

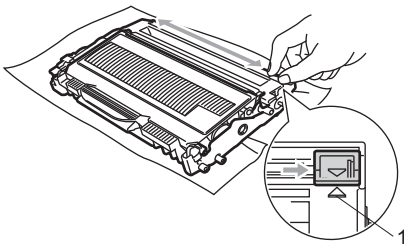

! CAUTION

Be sure to return the green tab to the home position (▲) (1). If you do not, printed pages may have a vertical stripe.

- 8 Put the drum unit and toner cartridge assembly back in the machine.

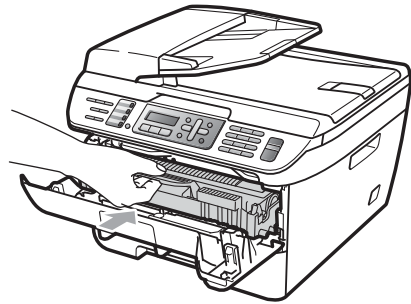

- 9 Close the front cover.

! CAUTION

DO NOT turn off the machine or open the front cover until the LCD returns to the standby state.

Replacing the drum unit

The machine uses a drum unit to create print images on paper. If the LCD shows *Drum End Soon*, the drum unit is near the end of its life and it is time to buy a new one. Even if the LCD shows *Drum End Soon*, you may be able to continue printing without having to replace the drum unit for a while. However, if there is a noticeable deterioration in the output print quality (even before *Drum End Soon* appears), then the drum unit should be replaced. You should clean the machine when you replace the drum unit. (See *Cleaning the laser scanner window* on page 116.)

! CAUTION

While removing the drum unit, handle it carefully because it may contain toner. If toner scatters on your hands or clothes, wipe or wash it off with cold water at once.

 **Note**

The drum unit is a consumable item, and it is necessary to replace it periodically. There are many factors that determine the actual drum life, such as temperature, humidity, type of paper and how much toner you use for the number of pages per print job. The estimated drum life is approximately 12,000 pages¹. The actual number of pages your drum will print may be significantly less than this estimate. Because we have no control over the many factors that determine the actual drum life, we cannot guarantee a minimum number of pages that will be printed by your drum.

¹ Drum yield is approximate, and may vary by type of use.

 **WARNING**

 **HOT SURFACE**

After you have just used the machine, some internal parts of the machine will be extremely hot. To prevent injury, when you open the front or back cover (back output tray) of the machine, DO NOT touch the shaded parts shown in the illustration.

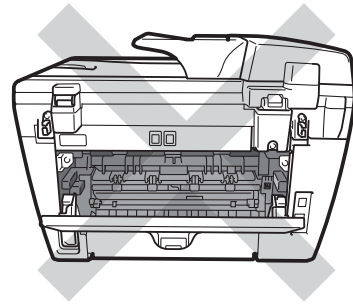
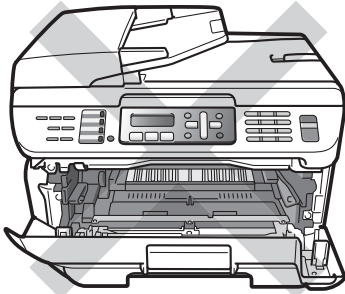

- 1 Open the front cover.

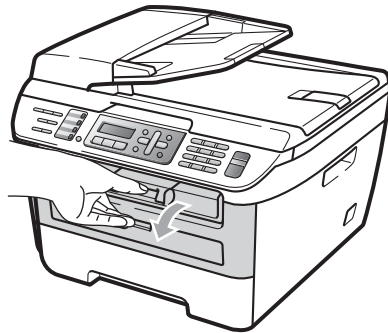

- 2 Slowly take out the drum unit and toner cartridge assembly.

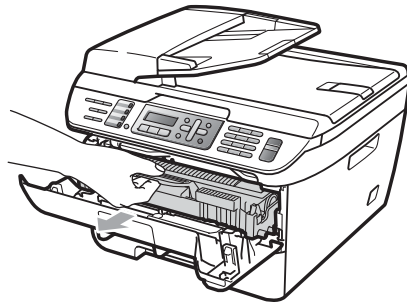

 **CAUTION**

We recommend that you put the drum unit and toner cartridge assembly on a clean, flat surface with a sheet of disposable paper or cloth underneath it in case you accidentally spill or scatter toner.

To prevent damage to the machine caused by static electricity, **DO NOT** touch the electrodes shown in the illustration.

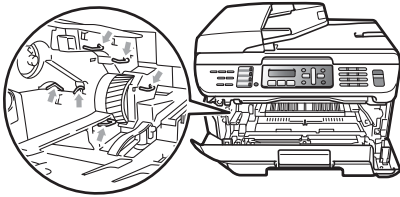

- 3 Push down the green lock lever and take the toner cartridge out of the drum unit.

! CAUTION

To avoid print quality problems, **DO NOT** touch the shaded parts shown in the illustrations.

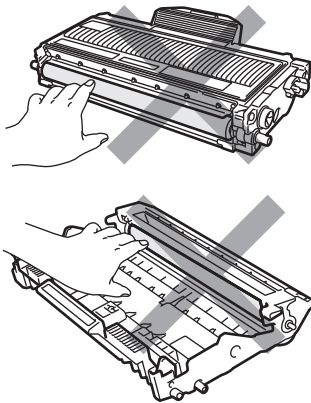

Wait to unpack a new drum unit until immediately before you put it in the machine. Exposure to direct sunlight or room light may damage the drum unit.

Note

Be sure to seal up the used drum unit tightly in a bag so that toner powder does not spill out of the unit.

- 4 Unpack the new drum unit.
- 5 Put the toner cartridge firmly into the new drum unit until you hear it lock into place. If you put the cartridge in correctly, the green lock lever will lift automatically.

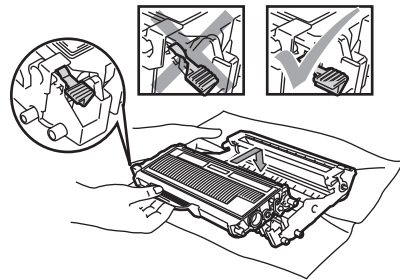

! CAUTION

Make sure that you put in the toner cartridge correctly or it may separate from the drum unit.

- 6 Clean the corona wire of the drum unit by gently sliding the green tab from right to left and left to right several times.

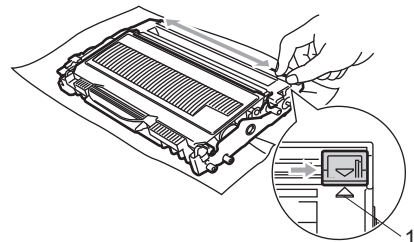

! CAUTION

Be sure to return the green tab to the home position (▲) (1). If you do not, printed pages may have a vertical stripe.

- Put the new drum unit and toner cartridge assembly in the machine.

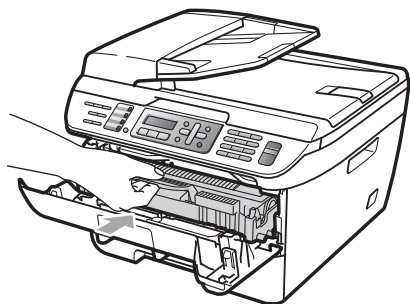

- Press **Clear/Back**.
To confirm you are installing a new drum, press **1**.
- When the LCD shows *Accepted*, close the front cover.

Machine information

Checking the serial number

You can see the machine's serial number on the LCD.

- (For MFC-7320) Press **Menu, 4, 1**.
(For MFC-7440N) Press **Menu, 5, 1**.
(For MFC-7840W) Press **Menu, 6, 1**.
- Press **Stop/Exit**.

Checking the page counters

You can see the machine's page counters for copies, printed pages, reports and lists, faxes or a summary total.

- (For MFC-7320) Press **Menu, 4, 2**.
(For MFC-7440N) Press **Menu, 5, 2**.
(For MFC-7840W) Press **Menu, 6, 2**.
- Press **▲** or **▼** to choose *Total*, *Fax/List*, *Copy* or *Print*.
You can see the machine's page count.
- Press **Stop/Exit**.

Checking the Drum life

You can see the machine's drum life on the LCD.

- (For MFC-7320) Press **Menu, 4, 3**.
(For MFC-7440N) Press **Menu, 5, 3**.
(For MFC-7840W) Press **Menu, 6, 3**.
- Press **OK**.
You can see the remaining percentage of drum life.
- Press **Stop/Exit**.

Packing and shipping the machine

! CAUTION

Make sure that the machine has fully cooled down by leaving it disconnected from the power for at least 30 minutes before packing.

When you transport the machine, use the packing materials that came with your machine. If you do not pack the machine correctly, you could void your warranty.

- 1 Turn off the machine.
- 2 Unplug the machine from the telephone wall socket.
- 3 Unplug all the cables and AC power cord from the machine.
- 4 Open the front cover.
- 5 Remove the drum unit and toner cartridge assembly. Leave the toner cartridge installed in the drum unit.
- 6 Place the drum unit and toner cartridge assembly into the plastic bag and seal the bag.
- 7 Close the front cover.
- 8 Wrap the machine in the plastic bag and place it in the original carton with the original packing material.
- 9 Pack the drum unit and toner cartridge assembly, AC cord and printed materials in the original carton as shown below:
- 10 Close the carton and tape it shut.

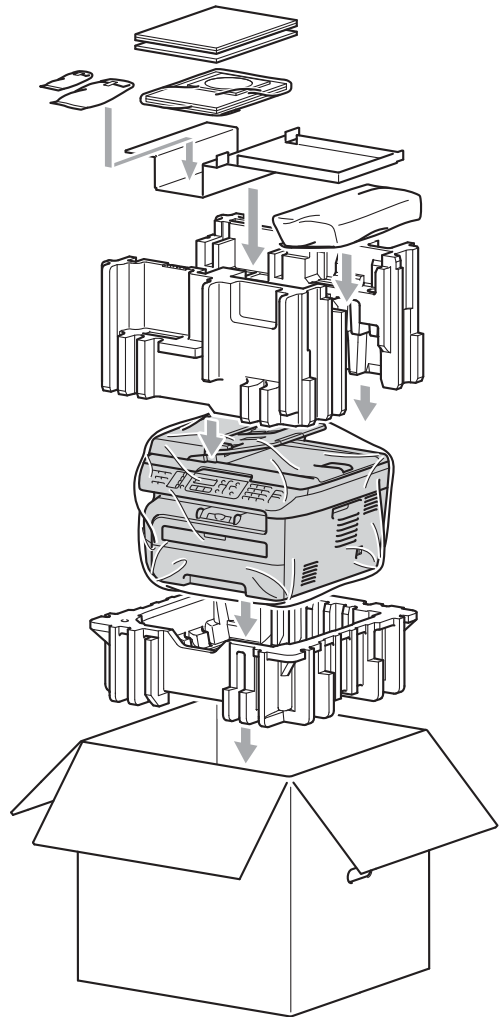

C

Menu and features

On-screen programming

Your machine has been designed to be easy to use. The LCD provides on-screen programming using the menu keys.

We have created step by step on-screen instructions to help you program your machine. Simply follow the steps as they guide you through the menu selections and programming options.

Menu table

You can program your machine by using the *Menu table* on page 132. These pages list the menu selections and options.

Press **Menu** followed by the menu numbers to program your machine.







For example, to set *Beeper volume* to *Low*:

- 1 Press **Menu**, **1**, **4**, **2**.
- 2 Press **▲** or **▼** to choose *Low*.
- 3 Press **OK**.

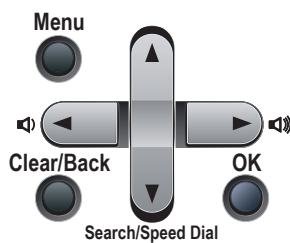
Memory storage

Your menu settings are stored permanently, and in the event of a power failure will *not* be lost. Temporary settings (for example, Contrast, Overseas Mode) *will* be lost. The MFC-7840W can store the date and time up to 4 days.

Menu keys

	
	Access the menu.
	Go to the next menu level. Accept an option.
	Exit the menu by pressing repeatedly. Go back to the previous menu level.
	Scroll through the current menu level.
	Go back to the previous menu level or forward to the next menu level.
	Exit the menu.

How to access the menu mode

- 1 Press **Menu**.
- 2 Choose an option.
 - Press **1** for General Setup menu.
 - Press **2** for Fax menu.
 - Press **3** for Copy menu.
 - (MFC-7320 only)
Press **4** for Machine info. menu.
 - (MFC-7440N only)
Press **4** for LAN menu.
Press **5** for Machine Info. menu.
 - (MFC-7840W only)
Press **4** for Printer menu.
Press **5** for LAN menu.
Press **6** for Machine info. menu.
 - Press **9** for Service menu. ¹
 - Press **0** for Initial Setup.

¹ This will appear only when the LCD shows an error message.

You can also scroll through each menu level by pressing **▲** or **▼** for the direction you want.

- 3 Press **OK** when the option you want appears on the LCD.
The LCD will then show the next menu level.
- 4 Press **▲** or **▼** to scroll to your next menu selection.
- 5 Press **OK**.
When you have finished setting an option, the LCD will show *Accepted*.
- 6 Press **Stop/Exit** to exit Menu mode.

Menu table

The factory settings are shown in Bold with an asterisk.

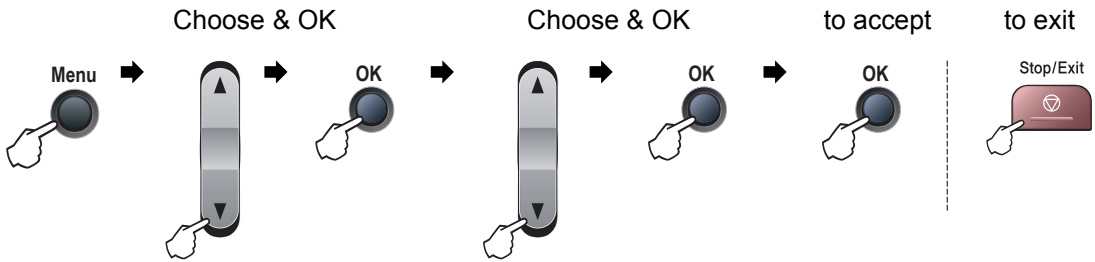

Main Menu	Submenu	Menu Selections	Options	Descriptions	Page
1.General Setup	1.Mode Timer	—	0 Sec 30 Secs 1 Min 2 Mins* 5 Mins Off	Sets the time to return to Fax mode and the time the machine will change from individual user to public user when using Secure Function Lock.	21 27
	2.Paper Type	—	Thin Plain* Thick Thicker Transparency Recycled Paper	Sets the type of paper in the paper tray.	21
	3.Paper Size	—	A4* Letter Executive A5 A6 B5 B6	Sets the size of the paper in the paper tray.	21

 The factory settings are shown in Bold with an asterisk.

Main Menu	Submenu	Menu Selections	Options	Descriptions	Page	
1. General Setup (continued)	4. Volume	1. Ring	Off Low Med* High	Adjusts the ring volume.	22	
		2. Beeper	Off Low Med* High	Adjusts the volume level of the beeper.	22	
		3. Speaker	Off Low Med* High	Adjusts the speaker volume.	22	
	5. Auto Daylight	—	On* Off	Changes for Daylight Savings Time automatically.	23	
	6. Ecology	1. Toner Save	On Off*	Increases the page yield of the toner cartridge.	23	
		2. Sleep Time	(00-99) 05Min*	Conserves power.	23	
	7. LCD Contrast	—	▼ -□□□■+ ▲ ▼ -□□□■+ ▲ ▼ -□□■□+ ▲* ▼ -□■□□+ ▲ ▼ -■□□□+ ▲	Adjusts the contrast of the LCD.	23	
	8. Security	1. TX Lock (MFC-7320 and MFC-7440N only)	—	Prohibits most operations except receiving faxes.	24	
		1. Function Lock (MFC-7840W only)	—	Can restrict selected machine operation for up to 10 individual users and all other non-authorized Public users.	25	
		2. Setting Lock	—	Stops unauthorized users from changing the machine's current settings.	28	
	2. Fax	1. Setup Receive (In Fax mode only)	1. Ring Delay	(00 - 08) 02* (Example for the UK)	Sets the number of rings before the machine answers in Fax Only or Fax/Tel mode.	41
	 The factory settings are shown in Bold with an asterisk.					

Main Menu	Submenu	Menu Selections	Options	Descriptions	Page
2.Fax (continued)	1.Setup Receive (continued)	2.F/T Ring Time	20 Secs 30 Secs* 40 Secs 70 Secs	Sets the pseudo/double-ringing time in Fax/Tel mode.	41
		3.Fax Detect	On* Off	Receives fax messages without pressing Start .	41
		4.Remote Codes	On (*51, #51) Off*	Allows you to answer all calls at an extension or external phone and use codes to turn the machine on or off. You can personalize these codes.	50
		5.Auto Reduction	On* Off	Cuts the size of incoming faxes.	42
		6.Memory Receive	On* Off	Automatically stores any incoming faxes in its memory if it runs out of paper.	43
		7.Print Density	▼ -□□□■+ ▲ ▼ -□□■□+ ▲ ▼ -□■□□+ ▲* ▼ -□■□□+ ▲ ▼ -■□□□+ ▲	Makes printouts darker or lighter.	42
		8.Polling RX	Standard* Secure Timer	Sets up your machine to poll another fax machine.	62
		9.Fax Rx Stamp	On Off*	Prints the received time and date on the top of the received faxes.	42
		2.Setup Send (In Fax mode only)	1.Contrast	Auto* Light Dark	Changes the lightness or darkness of faxes you send.
	2.Fax Resolution		Standard* Fine S.Fine Photo	Sets the default resolution for outgoing faxes.	36
	3.Delayed Fax		—	Sets the time of day in 24 hour format that the delayed faxes will be sent.	37



The factory settings are shown in Bold with an asterisk.

Main Menu	Submenu	Menu Selections	Options	Descriptions	Page
2. Fax (continued)	2. Setup Send (continued)	4. Batch TX	On Off*	Combines delayed faxes going to the same fax number at the same time of day into one transmission.	37
		5. Real Time TX	Next Fax:On Next Fax:Off On Off*	Sends a fax without using the memory.	36
		6. Polled TX	Standard* Secure	Sets up your machine with a document to be retrieved by another fax machine.	63
		7. Coverpg Setup	Next Fax:On Next Fax:Off On Off* Print Sample	Automatically sends a cover page you have programmed.	34
		8. Coverpage Note	—	Sets up your own comments for the fax cover page.	34
		9. Overseas Mode	On Off*	If you are having difficulty sending faxes overseas, set this to on.	37
	3. Set Quick Dial	1. One Touch Dial	—	Stores up to 8 One Touch Dial numbers, so you can dial by pressing one key (and Start).	52
		2. Speed Dial	—	Stores up to 200 Speed Dial numbers, so you can dial by pressing only a few keys (and Start).	53
		3. Setup Groups	—	Sets up to 8 Group numbers for Broadcasting.	54
	4. Report Setting	1. XMIT Report	On On+Image Off* Off+Image	Sets initial setup for Transmission Verification Report.	65

 The factory settings are shown in Bold with an asterisk.

Main Menu	Submenu	Menu Selections	Options	Descriptions	Page	
2.Fax (continued)	4.Report Setting (continued)	2.Journal Period	Off Every 50 Faxes* Every 6 Hours Every 12 Hours Every 24 Hours Every 2 Days Every 7 Days	Sets the interval for automatic printing of the Fax Journal.	65	
	5.Remote Fax Opt	1.Forward/Store (Backup Print)	Off* Fax Forward Fax Storage PC Fax Receive	Sets the machine to forward fax messages, to store incoming faxes in the memory (so you can retrieve them while you are away from your machine), or to send faxes to your PC. If you chose Fax Forward or PC Fax Receive, you can turn on the safety feature Backup Print.	56	
			2.Remote Access	---*	Sets your own code for Remote Retrieval.	59
			3.Print Document	—	Prints incoming faxes stored in the memory.	43
	6.Dial Restrict.	1.Dial Pad	Off* Enter # twice On	You can set the machine to restrict dialling when using the dial pad.	29	
			2.One Touch Dial	Off* Enter # twice On	You can set the machine to restrict the dialling of One Touch numbers.	29
				3.Speed Dial	Off* Enter # twice On	You can set the machine to restrict the dialling of Speed Dial numbers.
	7.Remaining Jobs	—	—	You can check which jobs are in the memory and lets you cancel scheduled jobs.	38	



The factory settings are shown in Bold with an asterisk.

Main Menu	Submenu	Menu Selections	Options	Descriptions	Page
2. Fax (continued)	0. Miscellaneous	1. Compatibility	High ¹ (MFC-7840W only) Normal* Basic (for VoIP) ¹ Factory setting for MFC-7840W	Adjusts the equalization for transmission difficulties. VoIP service providers offer fax support using various standards. If you regularly experience fax transmission errors, choose Basic (for VoIP).	102
		2. BT Call Sign (U.K. only)	On Off*	Used with BT Call Sign.	46
		3. Caller ID	On* Off Display ID Print Report	View or print a list of the last 30 Caller IDs stored in the memory.	44
3. Copy	1. Quality	—	Auto* Text Photo	You can choose the Copy resolution for your type of document.	71
	2. Contrast	—	▼ -□□□■+ ▲ ▼ -□□■□+ ▲ ▼ -□□■□+ ▲* ▼ -□■□□+ ▲ ▼ -■□□□+ ▲	Adjusts the contrast for copies.	72
4. Printer (MFC-7840W only)	1. Emulation	—	Auto* HP LaserJet BR-Script 3	Chooses the emulation mode.	See <i>Software User's Guide on the CD-ROM.</i>
	2. Print Options	1. Internal Font	—	Prints a list of the machine's internal fonts.	
		2. Configuration	—	Prints a list of the machine's printer settings.	
		3. Test Print	—	Prints a test page.	
3. Reset Printer	1. Reset 2. Exit	—	Restores the printer settings to the original factory default settings.		



The factory settings are shown in Bold with an asterisk.

Main Menu	Submenu	Menu Selections	Options	Descriptions	Page	
4. IAN (MFC-7440N only)	1. TCP/IP	1. BOOT Method	—	Auto* Static RARP BOOTP DHCP	Chooses the BOOT method that best suits your needs.	See <i>Network User's Guide on the CD-ROM.</i>
		2. IP Address	—	[000-255]. [000-255]. [000-255]. [000-255]	Enter the IP address.	
		3. Subnet Mask	—	[000-255]. [000-255]. [000-255]. [000-255]	Enter the Subnet mask.	
		4. Gateway	—	[000-255]. [000-255]. [000-255]. [000-255]	Enter the Gateway address.	
		5. Node Name	—	BRN XXXXXXXXXXXX	Enter the Node name.	
		6. WINS Config	—	Auto* Static	Chooses the WINS configuration mode.	
		7. WINS Server	—	(Primary) 000.000.000. 000 (Secondary) 000.000.000. 000	Specifies the IP address of the primary or secondary WINS server.	
		8. DNS Server	—	(Primary) 000.000.000. 000 (Secondary) 000.000.000. 000	Specifies the IP address of the primary or secondary DNS server.	
		9. APIPA	—	On* Off	Automatically allocates the IP address from the link-local address range.	



The factory settings are shown in Bold with an asterisk.

Main Menu	Submenu	Menu Selections		Options	Descriptions	Page
4. LAN (MFC-7440N only) (continued)	1. TCP/IP (continued)	0. IPv6	—	On Off*	Enable or Disable the IPv6 protocol. If you want to use the IPv6 protocol, visit http://solutions.brother.com/ for more information.	See <i>Network User's Guide on the CD-ROM.</i>
	2. Ethernet	—	—	Auto* 100B-FD 100B-HD 10B-FD 10B-HD	Chooses the Ethernet link mode.	
	3. Scan to FTP	—	Color 150 dpi* Color 300 dpi Color 600 dpi Gray 100 dpi Gray 200 dpi Gray 300 dpi B&W 200 dpi B&W 200x100 dpi	(If you chose colour option) PDF* JPEG (If you chose grey option) PDF JPEG* (If you chose B&W option) PDF* TIFF	Chooses the file format to send the scanned data via FTP.	
	0. Factory Reset	1. Reset	—	1. Yes 2. No	Restore all network settings to factory default.	
	2. Exit	—	—			
 The factory settings are shown in Bold with an asterisk.						

Main Menu	Submenu	Menu Selections		Options	Descriptions	Page
5. LAN (MFC-7840W only)	1. Wired	1. TCP/IP	1. BOOT Method	Auto* Static RARP BOOTP DHCP	Chooses the BOOT method that best suits your needs.	See <i>Network User's Guide on the CD-ROM.</i>
			2. IP Address	[000-255]. [000-255]. [000-255]. [000-255]	Enter the IP address.	
			3. Subnet Mask	[000-255]. [000-255]. [000-255]. [000-255]	Enter the Subnet mask.	
			4. Gateway	[000-255]. [000-255]. [000-255]. [000-255]	Enter the Gateway address.	
			5. Node Name	BRN XXXXXXXXXXXXXX	Enter the Node name.	
			6. WINS Config	Auto* Static	Chooses the WINS configuration mode.	
			7. WINS Server	(Primary) 000.000.000. 000 (Secondary) 000.000.000. 000	Specifies the IP address of the primary or secondary WINS server.	
			8. DNS Server	(Primary) 000.000.000. 000 (Secondary) 000.000.000. 000	Specifies the IP address of the primary or secondary DNS server.	
			9. APIPA	On* Off	Automatically allocates the IP address from the link-local address range.	
			0. IPv6	On Off*	Enable or Disable the IPv6 protocol. If you want to use the IPv6 protocol, visit http://solutions.brother.com/ for more information.	



The factory settings are shown in Bold with an asterisk.

Main Menu	Submenu	Menu Selections		Options	Descriptions	Page	
5. LAN (MFC-7840W only) (continued)	1. Wired (continued)	2. Ethernet	—	Auto* 100B-FD 100B-HD 10B-FD 10B-HD	Chooses the Ethernet link mode.	See <i>Network User's Guide on the CD-ROM.</i>	
		3. Set to Default	1. Reset 2. Exit	—	Restore the wired network setting to factory default.		
		4. Wired Enable	—	On* Off	Enable or Disable the Wired LAN manually.		
	2. WLAN	1. TCP/IP	1. BOOT Method	1. BOOT Method	Auto* Static RARP BOOTP DHCP		Chooses the BOOT method that best suits your needs.
			2. IP Address	2. IP Address	[000-255]. [000-255]. [000-255]. [000-255]		Enter the IP address.
			3. Subnet Mask	3. Subnet Mask	[000-255]. [000-255]. [000-255]. [000-255]		Enter the Subnet mask.
			4. Gateway	4. Gateway	[000-255]. [000-255]. [000-255]. [000-255]		Enter the Gateway address.
			5. Node Name	5. Node Name	BRW XXXXXXXXXXXX		Enter the Node name.
			6. WINS Config	6. WINS Config	Auto* Static		Chooses the WINS configuration mode.
			7. WINS Server	7. WINS Server	(Primary) 000.000.000. 000 (Secondary) 000.000.000. 000		Specifies the IP address of the primary or secondary WINS server.
 The factory settings are shown in Bold with an asterisk.							

Main Menu	Submenu	Menu Selections	Options	Descriptions	Page		
5. LAN (MFC-7840W only) (continued)	2. WLAN (continued)	1. TCP/IP (continued)	8. DNS Server	(Primary) 000.000.000.000 (Secondary) 000.000.000.000	Specifies the IP address of the primary or secondary DNS server.	See Network User's Guide on the CD-ROM.	
			9. APIPA	On* Off	Automatically allocates the IP address from the link-local address range.		
			0. IPv6	On Off*	Enable or Disable the IPv6 protocol. If you want to use the IPv6 protocol, visit http://solutions.brother.com/ for more information.		
		2. Setup Wizard	1. On 2. Off	—	You can configure your print server.		
		3. SES/WPS/AOSS	1. On 2. Off	—	You can easily configure your wireless network settings using the one-button push method.		
		4. WPS w/PIN Code	1. On 2. Off	—	You can easily configure your wireless network settings using WPS with a PIN code.		
		5. WLAN Status	1. Status	Active (11b) Active (11g) Wired LAN Active WLAN OFF Connection error	—		You can see the current wireless network status.
			2. Signal ¹	Strong Medium Weak None	—		You can see the current wireless network signal strength.
			3. SSID ¹	—	—		You can see the current SSID.
			4. Comm. Mode ¹	Ad-hoc Infrastructure	—		You can see the current Communication Mode.



The factory settings are shown in Bold with an asterisk.

¹ This setting only appears when WLAN Enable is On.

Main Menu	Submenu	Menu Selections		Options	Descriptions	Page
5. LAN (MFC-7840W only) (continued)	2. WLAN (continued)	6. Set to Default	1. Reset 2. Exit	—	Restore the wireless network setting to factory default.	See <i>Network User's Guide on the CD-ROM.</i>
		7. WLAN Enable	—	On Off*	Enable or Disable the wireless LAN manually.	
	3. Scan to FTP	—	Color 150 dpi* Color 300 dpi Color 600 dpi Gray 100 dpi Gray 200 dpi Gray 300 dpi B&W 200 dpi B&W 200x100 dpi	(If you chose colour option) PDF* JPEG (If you chose grey option) PDF JPEG* (If you chose B&W option) PDF* TIFF	Chooses the file format to send the scanned data via FTP.	
	0. Factory Reset	1. Reset	—	1. Yes 2. No	Restores all network settings to factory default.	
		2. Exit	—	—		
 The factory settings are shown in Bold with an asterisk.						

Main Menu	Submenu	Menu Selections	Options	Descriptions	Page
4. Machine Info. (MFC-7320) 5. Machine Info. (MFC-7440N) 6. Machine Info. (MFC-7840W)	1. Serial No.	—	—	You can check the serial number of your machine.	128
	2. Page Counter	—	Total Fax/List Copy Print	You can check the number of total pages the machine has printed during its life.	128
	3. Drum Life	—	—	You can check the percentage of Drum life that remains available.	128
0. Initial Setup	1. Receive Mode	—	Fax Only* Fax/Tel External TAD Manual	Chooses the receive mode that best suits your needs.	39
	2. Date&Time	—	—	Puts the date and time on the LCD and in headings of faxes you send.	<i>See Quick Setup Guide.</i>
	3. Station ID	—	Fax: Tel: Name:	Sets your name and fax number to appear on each page you fax.	
	4. Tone/Pulse	—	Tone* Pulse	Chooses the dialling mode.	
	5. Dial Tone	—	Detection No Detection*	You can shorten the dialling tone detect pause.	101
	6. Phone Line Set	—	Normal* PBX ISDN	Select the phone line type.	45
	0. Local Language (in Eastern Europe)	—	(Choose your language.)	Allows you to change the LCD language for your country.	<i>See Quick Setup Guide.</i>
 The factory settings are shown in Bold with an asterisk.					

Entering text

When setting certain menu selections, such as the Station ID, you will need to type text characters. The dial pad keys have letters printed on them. The keys: **0**, **#** and ***** do not have printed letters because they are used for special characters.

Press the appropriate dial pad key the number of times shown in this reference table to access the character you want.

Press Key	one time	two times	three times	four times	five times	six times	seven times	eight times	nine times
1	@	.	/	1	@	.	/	1	@
2	a	b	c	A	B	C	2	a	b
3	d	e	f	D	E	F	3	d	e
4	g	h	i	G	H	I	4	g	h
5	j	k	l	J	K	L	5	j	k
6	m	n	o	M	N	O	6	m	n
7	p	q	r	s	P	Q	R	S	7
8	t	u	v	T	U	V	8	t	u
9	w	x	y	z	W	X	Y	Z	9

For menu selections that do not allow lower case character selection, please use this reference table:

Press Key	one time	two times	three times	four times	five times
2	A	B	C	2	A
3	D	E	F	3	D
4	G	H	I	4	G
5	J	K	L	5	J
6	M	N	O	6	M
7	P	Q	R	7	P
8	T	U	V	8	T
9	W	X	Y	9	W

Inserting spaces

To enter a space in a fax number, press **▶** once between numbers. To enter a space in a name, press **▶** twice between characters.

Making corrections

If you entered a letter incorrectly and want to change it, press **◀** to move the cursor to the incorrect character, and then press **Clear/Back**.

Repeating letters

To enter a character on the same key as the previous character, press ► to move the cursor right before pressing the key again.

Special characters and symbols

Press *, # or 0, then press ◀ or ▶ to move the cursor to the symbol or character you want. Press **OK** to choose it. The symbols and characters below will appear depending on your menu selection.

Press *	for	(space) ! " # \$ % & ' () * + , - . / €
Press #	for	: ; < = > ? @ [] ^ _ ¥ ~ ' { }
Press 0	for	Ä Ë Ö Ü À Ç È É 0

General

Printer Type	Laser
Print Method	Electrophotography by semiconductor laser beam scanning
Memory Capacity	16 MB (MFC-7320) 32 MB (MFC-7440N and MFC-7840W)
LCD (liquid crystal display)	16 characters × 2 lines
Power Source	220 - 240V 50/60Hz
Power Consumption	Peak: 1056 W Copying: Average 320 W ¹ Sleep: (MFC-7320) Average 9 W (MFC-7440N) Average 10 W (MFC-7840W) Average 12 W Standby: Average 75 W

¹ When making a copy from one sheet

Dimensions

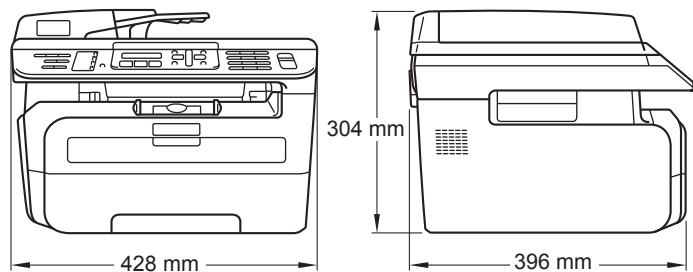

Weight

Without Drum/Toner Unit: 10 kg

Noise level

Sound power	
Operating (Copying):	LWAd = 6.2 Bell
Standby:	LWAd = 4.4 Bell
Sound pressure	
Operating (Copying):	LpAm = 53 dBA
Standby:	LpAm = 32 dBA

Temperature

Operating: 10 to 32.5°C

Storage: 5 to 35°C

Humidity

Operating: 20 to 80% (without condensation)

Storage: 10 to 90% (without condensation)

ADF (automatic document feeder)Up to 35 pages (Staggered) (80 g/m²)**Recommended Environment for Best Results:**

Temperature: 20 to 30°C

Humidity: 50% - 70%

Paper: Xerox Premier 80 g/m² or Xerox Business
80 g/m²**Paper Tray**250 Sheets (80 g/m²)

Print media

Paper Input	Paper Tray	
	■ Paper Type:	Plain paper, Transparencies ¹ or Recycled paper
	■ Paper Size:	Letter, A4, B5(ISO), A5, B6, A6 and Executive
	■ Paper Weight:	60 to 105 g/m ²
	■ Maximum paper tray capacity:	Up to 250 sheets of 80 g/m ² plain paper
	Manual Feed Slot	
	■ Paper Type:	Plain paper, Recycled paper, Transparencies, Bond paper, Envelopes or Labels
	■ Paper Size:	Width: 76.2 to 220 mm Length: 116 to 406.4 mm
	■ Paper Weight:	60 to 163 g/m ²
	■ Maximum manual feed slot capacity:	One sheet at a time

¹ For transparencies or labels, we recommend removing printed pages from the output paper tray immediately after they exit the machine to avoid the possibility of smudging.

Paper Output Up to 100 sheets (face down print delivery to the output paper tray)

Fax

Compatibility	ITU-T Group 3
Coding System	MH/MR/MMR (MFC-7320 and MFC-7440N) MH/MR/MMR/JBIG (MFC-7840W)
Modem Speed	Automatic Fallback: 14,400 bps (MFC-7320 and MFC-7440N) 33,600 bps (MFC-7840W)
Document Size	ADF Width: 148 to 215.9 mm ADF Length: 148 to 355.6 mm Scanner Glass Width: Max. 215.9 mm Scanner Glass Length: Max. 297 mm
Scanning Width	Max. 208 mm
Printing Width	Max. 208 mm
Greyscale	256 levels
Polling Types	Standard, Secure, Timer, Sequential
Contrast Control	Automatic/Light/Dark (manual setting)
Resolution	Horizontal: 8 dot/mm Vertical ■ Standard: 3.85 line/mm ■ Fine: 7.7 line/mm ■ Photo: 7.7 line/mm ■ Superfine: 15.4 line/mm
One Touch Dial	8 (4 × 2)
Speed Dial	200 stations
Groups	Up to 8
Broadcasting	258 stations
Automatic Redial	3 times at 5 minute intervals
Ring Delay	0, 1, 2, 3, 4, 5, 6, 7 or 8 rings (For UK and Ireland) 2, 3, 4, 5, 6, 7 or 8 rings (For South Africa)
Communication Source	Public switched telephone network
Memory Transmission	Up to 500 ¹ / ₄₀₀ ² pages (MFC-7320 and MFC-7440N) Up to 600 ³ / ₅₀₀ ⁴ pages (MFC-7840W)
Out of Paper Reception	Up to 500 ¹ / ₄₀₀ ² pages (MFC-7320 and MFC-7440N) Up to 600 ³ / ₅₀₀ ⁴ pages (MFC-7840W)

- 1 'Pages' refers to the 'Brother Standard Chart No. 1' (a typical business letter, Standard resolution, MMR code). Specifications and printed materials are subject to change without prior notice.
- 2 'Pages' refers to the 'ITU-T Test Chart #1' (a typical business letter, Standard resolution, MMR code). Specifications and printed materials are subject to change without prior notice.
- 3 'Pages' refers to the 'Brother Standard Chart No. 1' (a typical business letter, Standard resolution, JBIG code). Specifications and printed materials are subject to change without prior notice.
- 4 'Pages' refers to the 'ITU-T Test Chart #1' (a typical business letter, Standard resolution, JBIG code). Specifications and printed materials are subject to change without prior notice.

Copy

Colour/Monochrome	Monochrome
Document Size	ADF Width: 148 to 215.9 mm ADF Length: 148 to 355.6 mm Scanner Glass Width: Max. 215.9 mm Scanner Glass Length: Max. 297 mm Copy Width: Max. 210 mm
Multiple Copies	Stacks or Sorts up to 99 pages
Reduce/Enlarge	25% to 400% (in increments of 1%)
Resolution	Up to 600 × 600 dpi
First Copy Out Time	Less than 15 seconds ¹ (from READY mode)

¹ The first copy out time may vary depending on scanner lamp warm up time.

Scan

Colour/Monochrome	Yes
TWAIN Compliant	Yes (Windows® 2000 Professional/XP/ XP Professional x64 Edition/Windows Vista®) Mac OS® X 10.2.4 or greater
WIA Compliant	Yes (Windows® XP/Windows Vista®)
Colour Depth	24 bit colour
Resolution	Up to 19200 × 19200 dpi (interpolated) ¹ Up to 600 × 2400 dpi (optical) ¹ (From Scanner Glass) Up to 600 × 600 dpi (optical) ¹ (From ADF)
Document Size	ADF Width: 148.0 to 215.9 mm ADF Length: 148.0 to 355.6 mm Scanner Glass Width: Max. 215.9 mm Scanner Glass Length: Max. 297 mm
Scanning Width	Max. 210 mm
Greyscale	256 levels

¹ Maximum 1200 × 1200 dpi scanning with the WIA driver in Windows® XP/Windows Vista® (resolution up to 19200 × 19200 dpi can be chosen by using the Brother scanner utility)

Print

Emulations (MFC-7840W only)	PCL6, BR-Script3 (PostScript®3)
Printer Driver	Host-Based Driver for Windows® 2000 Professional/ XP/XP Professional x64 Edition/Windows Vista®/ (MFC-7440N and MFC-7840W only) Windows Server® 2003 (print only via network) (MFC-7840W only) BR-Script3 (PPD file) for Windows® 2000 Professional Macintosh® Printer Driver for Mac OS® X 10.2.4 or greater (MFC-7840W only) BR-Script3 (PPD file) for Mac OS® X 10.2.4 or greater
Resolution	HQ1200 (2400 × 600 dpi), 600, 300 dpi
Print Speed	Up to 18 pages/minute (A4 size) ¹ (MFC-7320) Up to 22 pages/minute (A4 size) ¹ (MFC-7440N and MFC-7840W)
First Print Out Time	Less than 10 seconds. (from the Ready state and the standard tray)

¹ The print speed may change depending on the type of document you print.

Interfaces

USB	Use a USB 2.0 interface cable that is no longer than 2.0 m. ¹ ²
LAN cable (MFC-7440N and MFC-7840W)	Use an Ethernet UTP cable category 5 or greater.
Wireless LAN (MFC-7840W)	Your machine supports IEEE 802.11b/g wireless communication with your wireless LAN using Infrastructure mode or a wireless Peer-to-Peer connection in Ad-hoc mode.

¹ Your machine has a Full-Speed USB 2.0 interface. The machine can also be connected to a computer that has a USB 1.1 interface.

² Third party USB ports are not supported.

Computer requirements

Minimum System Requirements and Supported PC Software Functions								
Computer Platform & Operating System Version		Supported PC Software Functions	PC Interface	Processor Minimum Speed	Minimum RAM	Recommended RAM	Hard Disk Space to install	
							For Drivers	For Applications
Windows® Operating System ¹	Windows® 2000 Professional ⁴	Printing, PC Fax, Scanning	USB, 10/100 Base Tx (Ethernet), Wireless 802.11 b/g (MFC-7840W only)	Intel® Pentium II® or equivalent	64 MB	256 MB	150 MB	310 MB
	Windows® XP Home® ^{2 4} Windows® XP Professional ^{2 4}				128 MB			
	Windows® XP Professional x64 Edition ²			64-bit (Intel®64 or AMD64) supported CPU	256 MB	512 MB		
	Windows Vista® ²			Intel® Pentium® 4 or equivalent 64-bit (Intel®64 or AMD64) supported CPU	512 MB	1 GB		
	Windows Server® 2003 (print only via network)	Printing	10/100 Base Tx (Ethernet), Wireless 802.11 b/g (MFC-7840W only)	Intel® Pentium® III or equivalent	256 MB	512 MB	50MB	N/A
Windows Server® 2003 x64 Edition (print only via network)	64-bit (Intel®64 or AMD64) supported CPU							

D

Macintosh® Operating System	Mac OS® X 10.2.4 - 10.4.3	Printing, PC Fax send, Scanning	USB ³ , 10/100 Base Tx (Ethernet), Wireless 802.11 b/g (MFC- 7840W only)	PowerPC G4/G5, PowerPC G3 350MHz	128 MB	256 MB	80 MB	400 MB
	Mac OS® X 10.4.4 or greater			PowerPC G4/G5, Intel® Core™ Processor	512 MB	1 GB		

¹ Microsoft® Internet Explorer 5.5 or greater.

² For WIA, 1200x1200 resolution. Brother Scanner Utility enables to enhance up to 19200 x 19200 dpi.

³ Third party USB ports are not supported.

⁴ PaperPort™ 11SE supports Microsoft® SP4 or higher for Windows® 2000 and SP2 or higher for XP.

Consumable items

Toner Cartridge Life	Standard Toner Cartridge:	
	TN-2110:	Approx. 1,500 pages (A4) ¹
	High-Yield Toner Cartridge:	
	TN-2120:	Approx. 2,600 pages (A4) ¹
Drum Unit	DR-2100:	Approx. 12,000 pages (A4) ²

¹ Approx. cartridge yield is declared in accordance with ISO/IEC 19752.

² Drum yield is approximate, and may vary by type of use.

Ethernet wired network (MFC-7440N and MFC-7840W)

Network board model name	NC-6600h (MFC-7440N)
LAN	You can connect your machine to a network for Network Printing, Network Scanning, PC Fax and Remote Setup. ^{1 2}
Support for	Windows [®] 2000 Professional, Windows [®] XP, Windows [®] XP Professional x64 Edition, Windows Vista [®] , Windows Server [®] 2003 and Windows Server [®] 2003 x64 Edition ² Mac OS [®] X 10.2.4 or greater ³
Protocols	TCP/IP for IPv4: ARP, RARP, BOOTP, DHCP, APIPA (Auto IP), WINS/NetBIOS name resolution, DNS resolver, mDNS, LPR/LPD, Custom Raw Port/Port9100, IPP, FTP server, POP before SMTP, SMTP AUTH, TELNET, SNMPv1, HTTP Server, FTP Client, TFTP Client and Server, SMTP Client, APOP, LLMNR responder, ICMP, Web Services TCP/IP for IPv6: (Turned off as default) NDP, RA, DNS resolver, mDNS, LPR/LPD, Custom Raw Port/Port9100, IPP, FTP Server, POP before SMTP, SMTP AUTH, TELNET, SNMPv1, HTTP Server, FTP Client, TFTP Client and Server, SMTP Client, APOP, LLMNR responder, ICMPv6, Web Services Other: LLTD responder
Network type	Ethernet 10/100 BASE-TX Auto Negotiation (Wired LAN)
Management utilities ⁴	BRAdmin Light for Windows [®] 2000 Professional, Windows [®] XP, Windows [®] XP Professional x64 Edition, Windows Vista [®] , Windows Server [®] 2003, Windows Server [®] 2003 x64 Edition and Mac OS [®] X 10.2.4 or greater BRAdmin Professional for Windows [®] 2000 Professional, Windows [®] XP, Windows [®] XP Professional x64 Edition, Windows Vista [®] , Windows Server [®] 2003 and Windows Server [®] 2003 x64 Edition Web BRAdmin for Windows [®] 2000 Professional, Windows [®] XP, Windows [®] XP Professional x64 Edition, Windows Vista [®] , Windows Server [®] 2003 and Windows Server [®] 2003 x64 Edition Client computers with a web browser supporting Java™.

¹ PC Fax Send for Mac[®]

² Printing only for Windows Server[®] 2003

³ Mac OS[®] X 10.2.4 or greater (mDNS)

⁴ BRAdmin Professional and Web BRAdmin are available as a download from <http://solutions.brother.com/>.

Ethernet wireless network (MFC-7840W only)

Network board model name	NC-7400w
LAN	You can connect your machine to a network for Network Printing, Network Scanning, PC Fax and Remote Setup ^{1 2} .
Support for	Windows [®] 2000 Professional, Windows [®] XP, Windows [®] XP Professional x64 Edition, Windows Vista [®] , Windows Server [®] 2003 and Windows Server [®] 2003 x64 Edition Mac OS [®] X 10.2.4 or greater ³
Protocols	TCP/IP for IPv4: ARP, RARP, BOOTP, DHCP, APIPA (Auto IP), WINS/NetBIOS name resolution, DNS resolver, mDNS, LPR/LPD, Custom Raw Port/Port9100, IPP, FTP server, POP before SMTP, SMTP AUTH, TELNET, SNMPv1, HTTP Server, FTP Client, TFTP Client and Server, SMTP Client, APOP, LLMNR responder, ICMP, Web Services TCP/IP for IPv6 (Turned off as default) NDP, RA, DNS resolver, mDNS, LPR/LPD, Custom Raw Port/Port9100, IPP, FTP Server, POP before SMTP, SMTP AUTH, TELNET, SNMPv1, HTTP Server, FTP Client, TFTP Client and Server, SMTP Client, APOP, LLMNR responder, ICMPv6, Web Services Other: LLTD responder
Network type	IEEE 802.11 b/g (Wireless LAN)
Management utilities ⁴	BRAdmin Light for Windows [®] 2000 Professional, Windows [®] XP, Windows [®] XP Professional x64 Edition, Windows Vista [®] , Windows Server [®] 2003, Windows Server [®] 2003 x64 Edition and Mac OS [®] X 10.2.4 or greater BRAdmin Professional for Windows [®] 2000 Professional, Windows [®] XP, Windows [®] XP Professional x64 Edition, Windows Vista [®] , Windows Server [®] 2003 and Windows Server [®] 2003 x64 Edition Web BRAdmin for Windows [®] 2000 Professional, Windows [®] XP, Windows [®] XP Professional x64 Edition, Windows Vista [®] , Windows Server [®] 2003 and Windows Server [®] 2003 x64 Edition Client computers with a web browser supporting Java™.

¹ PC Fax Send for Mac[®]

² Only printing for Windows Server[®] 2003

³ Mac OS[®] X 10.2.4 or greater (mDNS)

⁴ BRAdmin Professional and Web BRAdmin are available as a download from <http://solutions.brother.com/>.

Authentication and encryption for wireless users only

Authentication method

The Brother machine supports the following methods:

- Open system

Wireless devices are allowed to access the network without any authentication.

- Shared key

A secret pre-determined key is shared by all devices that will access the wireless network. The Brother machine uses the WEP keys as the pre-determined key.

- WPA-PSK/WPA2-PSK

Enables a Wi-Fi[®] Protected Access Pre-Shared Key (WPA-PSK/WPA2-PSK), which enables the Brother wireless machine to associate with access points using TKIP for WPA-PSK or AES for WPA-PSK and WPA2-PSK (WPA-Personal).

- LEAP

Cisco[®] LEAP (Light Extensible Authentication Protocol) has been developed by Cisco Systems, Inc. and enables the Brother wireless product to associate with access points using CKIP and CMIC encryptions.

Encryption methods

Encryption is used to secure the data that is sent over the wireless network. The Brother machine supports the following encryption methods:

- WEP

By using WEP (Wired Equivalent Privacy), the data is transmitted and received with a secure key.

- TKIP

TKIP (Temporal Key Integrity Protocol) provides per-packet key mixing a message integrity check and re-keying mechanism.

- AES

AES (Advanced Encryption Standard) is Wi-Fi[®] authorized strong encryption standard.

- CKIP

The original Key Integrity Protocol for LEAP by Cisco Systems, Inc.

- CMIC

CMIC (Cisco Message Integrity Check) is the message integrity check mechanism for LEAP by Cisco Systems, Inc.

Network key

There are some rules for each security method:

■ Open system/Shared key with WEP

This key is a 64-bit or 128-bit value that must be entered in an ASCII or hexadecimal format.

- 64 (40) bit ASCII:

Uses 5 text characters. e.g. "WLAN" (this is case sensitive).

- 64 (40) bit hexadecimal:

Uses 10 digits of hexadecimal data. e.g. "71f2234aba"

- 128 (104) bit ASCII:

Uses 13 text characters. e.g. "Wirelesscomms" (this is case sensitive)

- 128 (104) bit hexadecimal:

Uses 26 digits of hexadecimal data. e.g. "71f2234ab56cd709e5412aa2ba"

■ WPA-PSK/WPA2-PSK and TKIP or AES

Uses a Pre-Shared Key (PSK) that is 8 or more characters in length, up to a maximum of 63 characters.

■ LEAP

Uses User ID and Password.

- User ID: less than 64 characters in length.
- Password: less than 32 characters in length.

Wi-Fi Alliance certification

This wireless Ethernet multi-function print server is a Wi-Fi certified IEEE 802.11b/802.11g product by the Wi-Fi Alliance. The Wi-Fi Alliance certification ensures the interoperability of other wireless LAN products based on the IEEE 802.11 specification. For more information on the Wi-Fi Alliance and other Wi-Fi certified products, visit <http://www.wi-fi.org/>.

Wireless one-push configuration

If your wireless access point supports either SecureEasySetup™, Wi-Fi Protected Setup™ (PBC¹) or AOSS™, you can configure the machine easily without a computer. By pushing a button on the wireless LAN router / access point and using the menu on the machine, you can set up the wireless network and security settings. See the User's Guide for your wireless LAN router / access point for instructions on how to access one-push mode.

¹ Push Button Configuration



Note

Routers or access points that support SecureEasySetup™, Wi-Fi Protected Setup™ or AOSS™ have the symbols shown below.



This is a comprehensive list of features and terms that appear in Brother manuals. Availability of these features depends on the model you purchased.

ADF (automatic document feeder)

The document can be placed in the ADF and scanned one page at a time automatically.

Auto Reduction

Reduces the size of incoming faxes.

Automatic fax transmission

Sending a fax without picking up the handset of the external telephone.

Automatic Redial

A feature that enables your machine to redial the last fax number after five minutes if the fax did not go through because the line was busy.

Backup Print

Your machine prints a copy of every fax that is received and stored in memory. This is a safety feature so you will not lose messages during a power failure.

Batch Transmission

As a cost saving feature, all delayed faxes to the same fax number will be sent as one transmission.

Beeper Volume

Volume setting for the beep when you press a key or make an error.

Broadcasting

The ability to send the same fax message to more than one location.

BT Call Sign

A subscriber service purchased from the telephone company in the U.K. that gives you another phone number on an existing phone line. The Brother machine uses the new number to simulate a dedicated fax line.

Cancel Job

Cancels a programmed print job and clears the machine's memory.

CNG tones

The special tones (beeps) sent by fax machines during automatic transmission to tell the receiving machine that a fax machine is calling.

Coding method

Method of coding the information contained in the document. All fax machines must use a minimum standard of Modified Huffman (MH). Your machine is capable of greater compression methods, Modified Read (MR), Modified Modified Read (MMR) and JBIG* (* MFC-7840W only), if the receiving machine has the same capability.

Communication error (or Comm. Error)

An error during fax sending or receiving, usually caused by line noise or static.

Compatibility group

The ability of one fax unit to communicate with another. Compatibility is assured between ITU-T Groups.

Contrast

Setting to compensate for dark or light documents, by making faxes or copies of dark documents lighter and light documents darker.

Delayed Fax

Sends your fax at a specified later time that day.

Dual Access

Your machine can scan outgoing faxes or scheduled jobs into memory at the same time it is sending a fax or receiving or printing an incoming fax.

ECM (Error Correction Mode)

Detects errors during fax transmission and resends the pages of the fax that had an error.

Extension telephone

A telephone on the fax number that is plugged into a separate wall socket.

External phone

A TAD (telephone answering device) or telephone that is connected to your machine.

F/T Ring Time

The length of time that the Brother machine pseudo/double-rings (when the Receive Mode setting is Fax/Tel) to notify you to pick up a voice call that it answered.

Fax Detect

Enables your machine to respond to CNG tones if you interrupt a fax call by answering it.

Fax Forwarding

Sends a fax received into the memory to another pre-programmed fax number.

Fax Journal

Lists information about the last 200 incoming and outgoing faxes. TX means Transmit. RX means Receive.

Fax Storage

You can store faxes in the memory.

Fax tones

The signals sent by sending and receiving fax machines while communicating information.

Fax/Tel

You can receive faxes and telephone calls. Do not use this mode if you are using a telephone answering device (TAD).

Fine resolution

Resolution is 203 × 196 dpi. It is used for small print and graphs.

Greyscale

The shades of grey available for copying and faxing photographs.

Group number

A combination of One Touch and Speed Dial numbers that are stored on a One Touch key or in a Speed Dial location for Broadcasting.

Help list

A printout of the complete Menu table that you can use to program your machine when you do not have the User's Guide with you.

Journal Period

The pre-programmed time period between automatically printed Fax Journal Reports. You can print the Fax Journal on demand without interrupting the cycle.

LCD (liquid crystal display)

The display screen on the machine that shows interactive messages during On-Screen Programming and shows the date and time when the machine is idle.

Manual fax

When you lift the handset of your external telephone so you can hear the receiving fax machine answer before you press **Start** to begin transmission.

Menu mode

Programming mode for changing your machine's settings.

OCR (optical character recognition)

The bundled ScanSoft™ PaperPort™ 11SE with OCR or Presto!® PageManager® software application converts an image of text to text you can edit.

One Touch

Keys on the machine's control panel where you can store numbers for easy dialling. You can store a second number on each key if you press **Shift** and the One Touch key together.

Out of Paper Reception

Receives faxes into the machine's memory when the machine is out of paper.

Overseas Mode

Makes temporary changes to the fax tones to accommodate noise and static on overseas telephone lines.

Pause

Allows you to place a 2.8 second delay in the dialling sequence while you are dialling using the dial pad or while you are storing One Touch and Speed Dial numbers. Press **Redial/Pause** as many times as needed for longer pauses.

Polling

The process of a fax machine calling another fax machine to retrieve waiting fax messages.

Pulse

A form of rotary dialling on a telephone line.

Real Time Transmission

When memory is full, you can send faxes in real time.

Remaining jobs

You can check which programmed fax jobs are waiting in the memory and cancel the jobs individually.

Remote Access Code

Your own four-digit code (— — —*) that allows you to call and access your machine from a remote location.

Remote Activation code

Press this code (* 5 1) when you answer a fax call on an extension or external telephone.

Remote Retrieval Access

The ability to access your machine remotely from a touch tone telephone.

Resolution

The number of vertical and horizontal lines per inch.

Ring Delay

The number of rings before the machine answers in **Fax Only** and **Fax/Tel** modes.

Ring Volume

Volume setting for the machine's ring.

Scanning

The process of sending an electronic image of a paper document into your computer.

Search

An electronic, alphabetical listing of stored One Touch, Speed Dial and Group numbers.

Speed Dial

A pre-programmed number for easy dialling. You must press **Search/Speed Dial**, then enter the three-digit Speed Dial location and press **Start** to begin the dialling process.

Station ID

The stored information that appears on the top of faxed pages. It includes the sender's name and fax number.

TAD (telephone answering device)

You can connect an external TAD to your machine.

Tel Index List

A listing of names and numbers stored in One Touch and Speed Dial memory, in numerical order.

Temporary settings

You can choose certain options for each fax transmission and copy without changing the default settings.

Tone

A form of dialling on the telephone line used for Touch Tone telephones.

Transmission

The process of sending faxes over the telephone lines from your machine to the receiving fax machine.

User Settings List

A printed report that shows the current settings of the machine.

Xmit Report (Transmission Verification Report)

A listing for each transmission, that shows its date, time and number.

F

Index

A

ADF (automatic document feeder)	
faxing	32
using	19
Answering machine (TAD)	
connecting	46
Apple® Macintosh®	
See Software User's Guide on the CD-ROM.	
Automatic	
fax receive	40
easy receive	41
Fax Detect	41
fax redial	52

B

Broadcasting	33
cancelling	33
setting up groups for	54

C

Cancelling	
broadcast in process	33
fax jobs in memory	38
jobs awaiting redial	38
print jobs	8
remote fax options	58
Cleaning	
corona wire	118
drum unit	120
laser scanner window	116
scanner glass	115
Connecting	
external TAD (answering machine)	46
external telephone	48
Consumable items	122
Control panel overview	6
ControlCenter2 (for Macintosh®)	
See Software User's Guide on the CD-ROM.	
ControlCenter3 (for Windows®)	
See Software User's Guide on the CD-ROM.	

Copy	
contrast	68, 72
Enlarge/Reduce key	69
enter copy mode	68
keys	8, 69
multiple	68
N in 1 (page layout)	72
out of memory	73
quality	71
single	68
sort (ADF only)	71
temporary settings	69
using ADF	71
using scanner glass	72
Cordless telephone (non-Brother)	50
Cover page	34
custom comments	34
for all faxes	35
for next fax only	34
printed form	35

D

Delayed batch transmission	37
Dialling	
a pause	52
automatic fax redial	52
groups (broadcasting)	33
manual	51
one touch	51
restricting dialling	29
speed dial	51
using the Search key	51
Document	
how to load	19, 20
jam	109
Drum unit	
checking (remaining life)	128
cleaning	118, 120
replacing	125
Dual access	36

E

Enlarge/Reduce key	69
Envelopes	9, 14, 15, 17
how to load	11

Equalization	102
Error messages on LCD	103
Comm. Error	103
Init Unable XX	105
No Paper	105
Not Registered	51
Out of Memory	106
Print Unable XX	106
Scan Unable XX	107
Extension telephone, using	48, 49, 50
External telephone, connecting	48

F

Fax codes	
changing	50, 59
fax receive code	48, 50
remote access code	59
telephone answer code	48, 50
Fax forwarding	
changing remotely	60, 61
programming a number	56
Fax storage	56
printing from memory	43
turning off	58
turning on	56
Fax, stand-alone	
receiving	
easy receive	41
fax forwarding	61
fax receive stamp	42
from extension telephone	48, 50
polling receive	62
reducing to fit on paper	42
retrieving from a remote site	60, 61
ring delay, setting	41
sequential polling	63
telephone line interference	102
sending	21, 32
broadcasting	33
cancelling from memory	38
contrast	35
delayed batch	37
delayed fax	37
from ADF	32
from memory (dual access)	36
from scanner glass	32
manual	38
overseas	37
polled transmit	63

real time transmission	36
resolution	36
telephone line interference	102
Fax/Tel mode	
answering at extension telephones	48, 50
easy receive	41
F/T ring time (double-ring)	41
fax receive code	48, 50
receiving faxes	48
ring delay	41
telephone answer code	48, 50
Function Lock	25

G

Greyscale	164
Groups for broadcasting	54

H

HELP	66
Help List	66
LCD messages	130
Menu Table	130, 132
using menu keys	130

J

Jams	
document	109
paper	110
Job Cancel key	8

L

Labels	14, 15, 18
LCD (liquid crystal display)	8, 130
contrast	23
Help List	66

M

Machine information	
checking remaining life of drum unit ...	128
page counts	128
Macintosh®	
See Software User's Guide on the	
CD-ROM.	
Maintenance, routine	114

checking the remaining life of drum unit	128
replacing	
drum unit	125
toner cartridge	122
Manual	
dialling	51
receive	40
transmission	38
Memory	
storage	130
Menu Table	130, 132
using menu keys	130
Mode, entering	
copy	68
fax	32
scan	8
Multi-line connections (PBX)	47

N

N in 1 (page layout)	72
Network	
faxing	
See Software User's Guide on the CD-ROM.	
printing	
See Network User's Guide on the CD-ROM.	
scanning	
See Software User's Guide on the CD-ROM.	

O

One touch	
changing	53
setting up	52
using	51
Out of Memory message	38, 73, 106

P

Packing and shipping the machine	129
Page layout (N in 1)	72
Paper	14, 149
how to load	9
jam	110
recommended	14
size	15

size of document	152, 153
size of paper	150
tray capacity	15
type	15, 21
PaperPort™ 11SE with OCR	
See Software User's Guide on the CD-ROM and Help in the PaperPort™ 11SE application to access How-to-Guides.	
PC Fax	
See Software User's Guide on the CD-ROM.	
Polling	
polled transmit	63
polling receive	62
sequential polling	63
Power failure	130
Print	
difficulties	89, 91
drivers	154
fax from memory	43
Job Cancel key	8
keys	8
paper jams	110
quality	93, 96
reports	66
resolution	154
Secure key	8
specifications	154
Printing	
See Software User's Guide on the CD-ROM.	
Programming your machine	130

Q

Quality	
copying	71
printing	93, 96
Quick dial	52
broadcasting	33
using groups	33
group dial	
changing	53
setting up groups for broadcasting	54
one touch dial	
changing	53
custom scan profile	52
setting up	52
using	51
search	51

speed dial	
changing	53
custom scan profile	53
setting up	53
using	51

R

Redial/Pause key	52
Reducing	
copies	69
incoming faxes	42
Remote retrieval	59
access code	59
commands	61
getting your faxes	60
Remote setup	
See Software User's Guide on the CD-ROM.	
Replacing	
drum unit	125
toner cartridge	122
Reports	65, 66
Fax Journal	65, 66
journal period	65
Help List	66
how to print	66
Network Configuration	66
Tel Index List	66
Transmission Verification	65
User Settings	66
Resolution	
copy	152
fax (standard, fine, superfine, photo)	36, 150
print	154
scan	153
setting for next fax	36
Resolution key	8, 36
Restricted users	26
Ring delay, setting	41

S

Safety instructions	86
Scanner glass	
faxing	32
using	20

Scanning	
See Software User's Guide on the CD-ROM.	
Search/Speed Dial key	51, 54
Secure key	8
Security	
restricting dialling	29
Secure function lock	
administrator password	25
Public user	26
restricted users	26
Secure key	8
Setting lock	28
Serial number	
how to find	See inside front cover
Shipping the machine	129
Sleep time	23
Sort	71
Speed dial	
changing	53
setting up	53
using	51

T

TAD (telephone answering device), external	40
connecting	46
recording OGM	47
Tel/R key	8
Telephone line	
connections	46
difficulties	89
interference	102
multi-line (PBX)	47
Temporary copy settings	69
Text, entering	145
Toner cartridge, replacing	122
Toner save	23
Transparency	10, 14
Troubleshooting	89
document jam	109
error messages on LCD	103
if you are having difficulty	
copy quality	91
incoming calls	90
network	93
paper handling	92
print quality	93, 96
printing	89, 91

scanning	92
software	92
telephone line	102
maintenance messages on LCD	103
paper jam	110

V

Volume, setting

beeper	22
ring	22
speaker	22

W

Windows®

See Software User's Guide on the CD-ROM.

Wireless Network

See Software User's Guide and Network User's Guide on the CD-ROM.

brother®

This machine is approved for use in the country of purchase only, local Brother companies or their dealers will only support machines purchased in their own countries.